

aquapix®

WDL 1080 **FULL HD** Lagoon

1 · Introduction Of The Video Camera.....	6
2 · Preparation	7
1. Installing the battery	7
2. Charging the battery	8
3. Inserting/removing the memory card	8
4. Format the memory card	9
5. Setting the OSD language.....	10
6. Setting the date and time.....	10
7. Introduction of OSD icons.....	11
3 · Operation.....	15
1. Switching on/off the video camera.....	15
2. Switching between working modes	15
3. Video Recording	16
4. Taking photos	17
5. Recording audio	17
4 · Introduction of working mode menu	18
1. Capture Mode menu.....	18
2. Video Recording Mode menu	19
3. Setup menu	20

5 · Playback Mode	22
1. Playback video clips	22
2. Playback audio files	22
3. To explore the details of a photo	22
6. Making Connections	25
1. Connecting to a normal TV	25
2. Connecting to an HDTV	26
3. Connecting to a computer	26
4. PC Camera	27
7. Software Installation	27
8. Technical Specifications	29

Thank you for purchasing this digital video camera. Please read these operating instructions carefully in order to use the digital video camera correctly. Keep the instruction in a safe place after reading, so you can refer to it later.

Precautions for general use

Before using the video camera, please ensure that you read and understand the safety precautions described below.

- Do not try to open the case of the video camera or attempt to modify this video camera in any way. Maintenance and repair should be carried out only by authorized service providers.
- Use only the recommended power accessories. Use of power sources not expressly recommended for this equipment may lead to overheating, distortion of the equipment, fire, electrical shock or other hazards.

Precautions for waterproof

Waterproof performance

- The video camera's waterproof performance is equivalent IPX8
- Underwater time limit: Do not use the video camera underwater for more than 30 minutes and deeper than 3 meters to ensure water resistance.
- The video camera is not dust-proof.
- The supplied accessories are not waterproof.

Notes before going underwater:

(Do not do the following actions on sandy / dusty environment or near the water's edge, please check indoors)

- Check if the area surrounding the battery cover /jacks cover is clean, do not allow dirt or sand or foreign objects around it.
- Ensure that the battery cover /jacks cover has no cracks or scratches.
- Ensure that the battery cover /jacks cover is closed.
- Ensure that the video camera has no cracks, if the video camera has been dropped; it is recommended to return it to your dealer.

After using the video camera in the water

- Be sure to come ashore within 30 minutes after going underwater, this will maintain the appearance, quality and water resistance of the video camera.
- After taking pictures underwater, clean the video camera in a bucket of water without salt. Ensure that the battery cover /jacks cover is closed; then soak the video camera in the bucket of water for about 10 minutes. After 10 minutes, wipe the video camera and the lens dry with absorbent cotton. Place the camera in a well-ventilated cool place to dry naturally (do not place under

direct sunlight or exposed areas). Be sure to wait until the video camera is completely dry before opening the battery cover /jacks cover (open the cover while holding an absorbent cotton to dry off water or clean other impurities around the cover).

- Wipe off water drops on the video camera and the lens with a soft lint-free cloth (to avoid fiber) and place it in a well-ventilated place to dry. The battery cover /jacks cover can be opened only after dry to prevent water from entering the camera when opening.
- Before you open the battery cover /jacks cover, always wipe off water drops inside the cover. Note that it should face down when opening.

Notes on maintenance

- Be sure to wipe any dirt or sand off the waterproof sealing material or its contraction surface. Dirt or sand may scratch the material or the surface, making the video camera less resistant to water.
- Do not use any soapy water, mild detergents, alcohol or similar liquids to clean the video camera. They may make the video camera less resistant to water.
- The waterproof of sealing material is replaceable at cost. The material should be replaced once a year to maintain the video camera water resistance.
- If water accidentally enters the video camera or any problem occurs when it is in water, please get out of water immediately and take proper actions. Dry the video camera and send it to repair.

1. Introduction of the video camera

1: LCD screen

2: Left/Mode button

3: Up/Playback button

4: Right/Self-timer button

5: OK/MENU button

6: Down/Delete button

7: Charging LED

8: Wrist strap eyelet

9: Shutter button

10: Power button

11: T button (zoom in)

12: W button (zoom out)

13: LED flash light On/Off button

14: AV out jack

15: USB port

16: Jacks cover

17: HDMI port

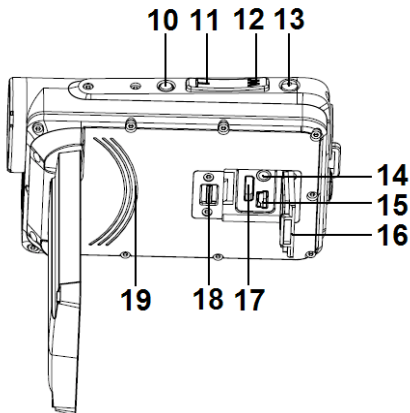
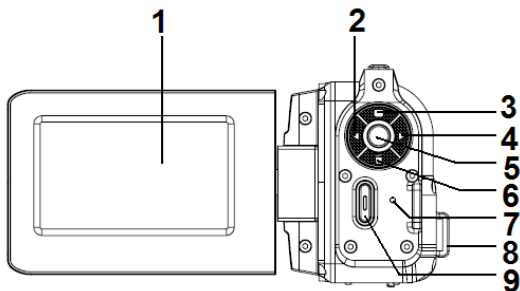

- 18: Jacks cover lock
- 19: Built-in speaker
- 20: Lens
- 21: Built-in microphone
- 22: LED flash light

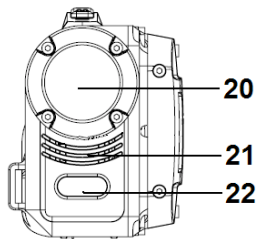

- 23: Tripod socket
- 24: Battery cover
- 25: Battery cover lock

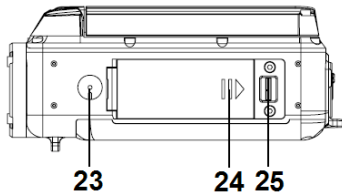

2 • Preparation

1. Installing the battery

- (a) Push the battery cover lock to the right to open the battery cover.
- (b) Insert the battery into the battery compartment. Please have the metal contacts aligned with the metal contacts in the compartment.
- (c) After the battery is properly installed, close the battery cover until the click sound is heard (if no click sound is heard, it shall mean that the cover has not been properly closed).

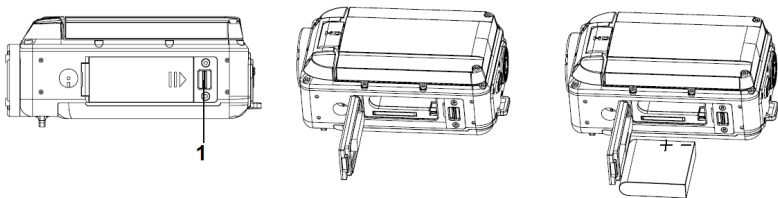

2. Charging the battery

- (a) Make sure the video camera is being switched off.
- (b) Connect the video camera with the computer via the USB cable.
- (c) The Charging LED will light in blue color white charging and will go off when the charging is done.

Note:

It is normal that the temperature of the video camera body rises during charging.

3. Inserting/removing the memory card

The camera accepts SD/SDHC card from 2GB to 32 GB. It is suggested to use the memory cards with capacity more than 4GB and the speeds faster than Class 4 to have the best performance for the 1080p video recording.

- (a) Make sure the video camera is being switched off.
- (b) Push the battery cover lock to the right to open the battery cover.
- (c) Insert the memory card in the video camera as illustrated.
- (d) Place back the battery cover.
- (e) To remove the memory card, please press down the memory card until it pops up.
- (f) Close the battery cover until the click sound is heard (if no click sound is heard, it shall mean that the cover has not been properly closed).

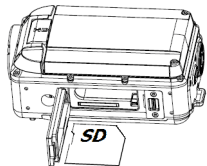

4. Format the memory card

It is important to format the memory card if it is first time to be used with the video camera. Please note that all data stored in the memory card will be deleted after the formatting therefore please make back-up of the data before you format the memory card.

- (a) Press the OK/MENU button to enter menu.
- (b) Press the Right button to select [Setup].
- (c) Use UP or DOWN button to select [Format] and press the OK/MENU button to enter the submenu.
- (d) Use UP or DOWN button to select [OK] and press the OK/MENU button to format the memory card.
- (e) Press LEFT/MODE button to exit the sub menu or keep pressing it to exit the menu.

5. Setting the OSD language

- (a) Press the OK/MENU button to enter menu.
- (b) Press the Right button to select [Setup ].
- (c) Use UP or DOWN button to select [Language] and press the OK/MENU button to enter the submenu.
- (d) Use UP or DOWN button to select the OSD language [OK] and press the OK/MENU button to confirm the setting.
- (e) Press LEFT/MODE button to exit the sub menu or keep pressing it to exit the menu.

6. Setting the date and time



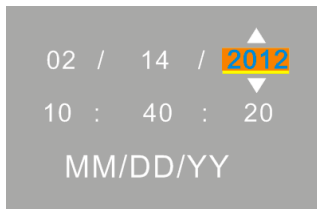

- (a) Press the OK/MENU button to enter menu.
- (b) Press the Right button to select [Setup ].
- (c) Use UP or DOWN button to select [Date] and press the OK/MENU button to enter the submenu.
- (d) Use UP or DOWN button to select [Set Date] and press the OK/MENU button to display the year, month, date, hour, minute and second.
- (e) Use LEFT or RIGHT to move the cursor to the preferred item (highlighted).
- (f) Use UP or DOWN button to change the setting and press the OK/MENU button to confirm the setting.
- (g) Press LEFT/MODE button to exit the sub menu or keep pressing it to exit the menu.



7. Introduction of OSD icons



Under Capture Mode []

1. Working mode

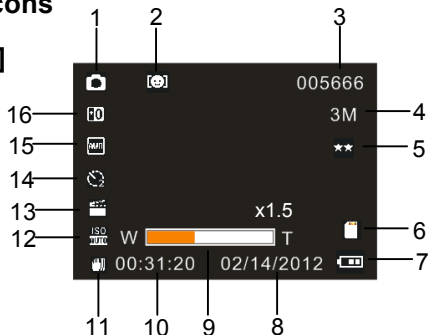
-  Capture mode
-  Video mode
-  Audio mode
-  Playback mode



2. Face Detection/Smile Capture

-  Face Detection
-  Smile Capture

3. Number of estimated photos

4. Image size

5. Image quality

6. Memory card inserted



Card unprotected



Card protected

8. Date

10. Time

12. ISO value



Auto

100

200

400



Super Fine



Fine



Normal

7. Battery power status



Full



Medium



Low



Drained

9. Zoom status

11. Anti-shake



On



Off

13. Scenes



Auto



Scenery



Portrait



Night Scenery



Night Portrait



High Sensitivity



Beach

14. Self-timer

Single



2S Timer



5S Timer



10S Timer

15. White Balance



Auto



Daylight



Cloudy



Fluorescent



Incandescent

16. Exposure value

Under Video Recording Mode []

1. Video recording mode icon
2. Estimated available recording time
3. Video size
4. Memory card inserted
5. Battery power status
6. Date
7. Zoom status
8. Time
9. Anti-shake
10. White Balance
11. Exposure

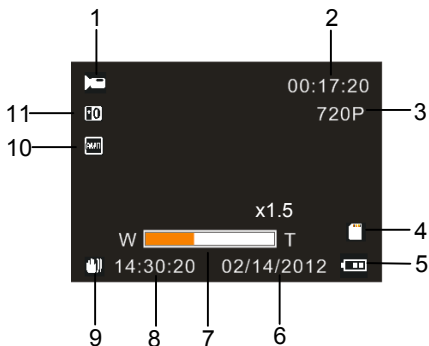

Under Audio Recording Mode [🔊]

1. Audio recording Mode icon
2. Estimated available recording time
3. Recording time
4. Memory card inserted
5. Battery power status

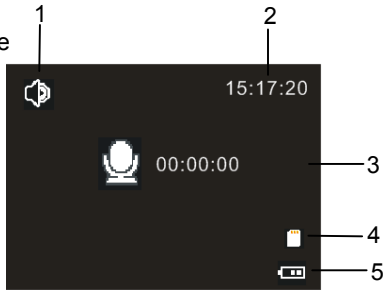

Playback Mode [▶]

1. Playback Mode icon
2. Image/video size
3. Length of the video clip
4. Current file number / number of total files
5. Length of the audio file
6. Battery power status
7. Date/time
8. Press the shutter button to start / stop playing the video/audio files.
Press the OK/MENU button to pause/resume the playing.

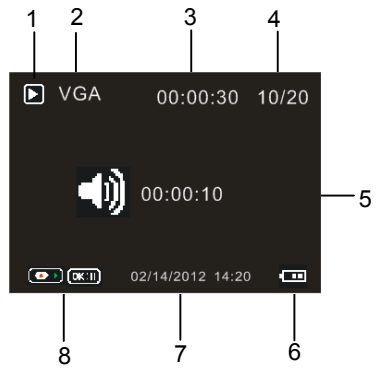

3 · Operation

1. Switching on/off the video camera



- (a) Slide open the LCD screen and the video camera will be switched on.
- (b) Slide close the LCD screen will switch off the video camera

You can also press the power button to switch on/off the video camera.
Note:

In order to save the battery power, the video camera will automatically switch off after the video camera is being idle for a certain period of time according to the user's setting (please refer to the "Setup menu")

2. Switching between working modes

There are three modes as in the following chart. Please press the LEFT/MODE button to switch and select the preferred working mode.

Icon	Title	Description
	Capture Mode	For taking photos.
	Video Recording Mode	For recording video clips.
	Audio Recording Mode	For recording audio files.

Note:

If you would like to enter the Playback Mode to playback the stored photos, movie clips and audio files, press the UP/PLAYBACK button to enter playback mode.

3. Video Recording

- (a) Switch on the video camera and the video camera will enter the video recording mode ().
- (b) Use the T or W button to adjust the zooming.
- (c) Press the LED flash light On/Off button on the top side of the video camera to activate or de-activate the LED flash light.
- (d) Press the shutter button to start/end the recording.

Note:

- **After reaching a max. video recording time of 29 minutes the camera will automatically stop. It can only be restarted manually.**
- The recording will automatically stop when the memory is full.
- It is requested to use memory cards with capacity of 4GB or more and the speeds faster than Class 4 for 1080p video recording. If “Slow card” shows on the LCD screen, even when it is set at 1080p video size, the video camera will downsize the video to 720p automatically.

4. Taking photos

- (a) Switch on the video camera.
- (b) Press the LEFT/MODE button to switch to the Capture Mode ().
- (c) Use the T or W button to adjust the zooming.
- (d) Press the LED flash light On/Off button on the top side of the video camera to activate or de-activate the LED flash light.
- (e) Hold the video camera steady and press the shutter button to take the photo.

5. Recording audio

- (a) Switch on the video camera.
- (b) Press the LEFT/MODE button to switch to the Audio Recording Mode ().
- (c) Press the shutter button to start the recording.
- (d) Press the OK/MENU button to pause/resume the recording.
- (e) Press the shutter button again to stop the recording.

4 · Introduction of working mode menu

Under the Video Recording Mode, Capture Mode and Audio Recording Mode, press the OK/MENU button to enter the corresponding menu.

1. Capture Mode menu



- Use the UP or DOWN button to select the preferred item.
- Press the OK/MENU button to enter the submenu.
- Use the UP or DOWN button to select the preferred item.
- Press the OK/MENU button to confirm the setting.
- Press LEFT/MODE button to exit the sub menu or keep pressing it to exit the menu.

Item	Description
Capture Mode	For setting the time for self-timer. --Single / 2S Timer / 5S Timer / 10S Timer
Resolution	12M: 4000x3000 / 10M: 3648X2736 / 9M: 3456X2592 8M: 3264x2448 / 7M: 3072X2304 / 5M: 2592x1944 3M: 2048x1536 / 2M: 1600x1200 / VGA: 640x480.
Quality	Super Fine / Fine / Normal
Sharpness	Sharp / Normal / Soft

Exposure	The exposure value range is -2 to +2
White Balance	Auto / Daylight / Cloudy / Fluorescent / Incandescent
Color	Standard / Sepia / Monochrome / Vivid
ISO	Auto / 100 / 200 / 400
Scene Mode	Auto / Scenery / Portrait / Night Scenery / Night Portrait / High Sensitivity / Beach
Face Detect	Off: Without face detection and smile capture function. Face Detect: To activate the face detection. Smile Capture: To activate the smile shutter.
Anti-Shake	On / Off
Continue Shot	To take 5 continuous photos with one shutter release. --On / Off

2. Video Recording Mode menu

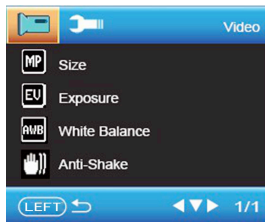

- Use the UP or DOWN button to select the preferred item.
- Press the OK/MENU button to enter the submenu.
- Use the UP or DOWN button to select the preferred item.

- (d) Press the OK/MENU button to confirm the setting.
- (e) Press LEFT/MODE button to exit the sub menu or keep pressing it to exit the menu.

Item	Description
Size	1080P:1920x1080 (25fps) 720P:1280x720 (30fps) VGA: 640x480 (30fps) QVGA: 320x240 (30fps)
Exposure	The exposure value range is -2 to +2
White Balance	Auto / Daylight / Cloudy / Fluorescent / Incandescent
Anti-Shake	On / Off

3. Setup menu

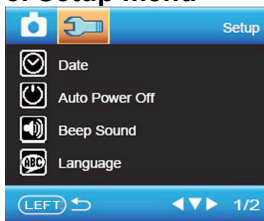

- (a) Press the OK/MENU button to enter the menu.
- (b) Press RIGHT button and select [Setup] menu.
- (c) Use the UP or DOWN button to select the preferred item.
- (d) Press the OK/MENU button to enter the submenu.
- (e) Use the UP or DOWN button to select the preferred item.

- (f) Press the OK/MENU button to confirm the setting.
- (g) Press LEFT/MODE button to exit the sub menu or keep pressing it to exit the menu.

Item	Description
Date	Allows you to set the date and time. --On / Off / Set date
Auto Power Off	The video camera will switch off automatically to save power at the set auto power off time --1 Minute / 3 Minutes / 5 Minutes / Off
Beep Sound	On / Off
Language	English / French / German / Italian / Spanish / Dutch / Portuguese
Frequency	50Hz / 60Hz
TV Mode	NTSC / PAL
Format	For formatting the memory card. --Cancel / OK
Default Setting	To set the video camera back to the factory default setting. --Cancel / OK

5 · Playback Mode

Press the UP/PLAYBACK button to enter the Playback Mode. Use the LEFT or RIGHT button to playback the desired file.

1. Playback video clips

- (a) Press the shutter button to start the playing or end the playing.
- (b) Press the OK/MENU button can pause or resume the playing.
- (c) Use the T or W button to adjust the sound volume.

2. Playback audio files

- (a) Press the shutter button to start the playing or end the playing.
- (b) Press the OK/MENU button can pause or resume the playing.

3. To explore the details of a photo

- (a) When a photo is displayed on the LCD screen, press the T or W button to zoom in or zoom out the photo.
- (b) When a photo is zoomed in (enlarged), press the OK/MENU button to fix the size of the photo.
- (c) Use LEFT/RIGHT/UP/DOWN buttons to explore the details of the photo.
- (d) Press the OK/MENU button and then W button continuously to exit the

photo exploring.

Thumbnails

Under Playback Mode, press W button to enter the thumbnails. Use LEFT/RIGHT/UP/DOWN buttons to select the preferred file and press OK/MENU button to view the file in full size.

Shortcut to deleting a single file

- (a) Select a file and press the DOWN button.
- (b) Select YES to delete the file or select NO to cancel the request.
- (c) Press OK/MENU button to confirm.

Deleting all files

- (a) Select a file and press the OK/MENU button to enter the menu.
- (b) Use the UP or DOWN button to select the Delete menu.
- (c) Press the OK/MENU button to enter the submenu.
- (d) Use the UP or DOWN button to select "Delete All Images?".
- (e) Press the OK/MENU button to enter the submenu.
- (f) Use the UP or DOWN button to select the "OK" menu to confirm for file deletion or select "Cancel" to cancel the request.
- (g) Press OK/MENU button to confirm.

Playback Mode menu

- (a) Under Playback Mode please press the OK/MENU button to enter the menu.
- (b) Use the UP or DOWN button to select the preferred item.
- (c) Press the OK/MENU button to enter the submenu.

- (d) Use the UP or DOWN button to select the preferred item.
- (e) Press the OK/MENU button to confirm the setting.
- (f) Press LEFT/MODE button to exit the sub menu or keep pressing it to exit the menu.

Item	Description
Delete	Use this function to delete a single file or all files. --Delete Current Image: Delete current single file. --Delete All Images: Delete all files except locked files. --Cancel: No file deletion.
Rotate	Use this function to rotate the photo. --90°: Rotate the photo by 90° in clockwise. --180°: Rotate the image 180° in clockwise. --270°: Rotate the image 270° in clockwise. --Cancel: No rotation.
Protect	Use this function to protect the file from being deleted by accident. --Lock Current: Lock the current file. --Unlock Current: Unlock the current file. --Lock All: Lock all files. --Unlock All: Unlock all files.
Crop	Crop: Use the UP/DOWN/LEFT/RIGHT buttons to move the crop frame. Press the shutter button to fixing the cropping frame. Press the shutter button again to do the cropping and the cropped image will be saved as a new file. --Cancel: No cropping the photo.

Slide Show	To play the photos by slideshow. Press the shutter button or OK/MENU button to exit the slideshow. --3 Seconds / 5 Seconds / 10 Seconds
Pictbridge	Use this function to print photos by connecting the video camera to a printer which supports PictBridge. --Print / Cancel

6. Making Connections

1. Connecting to a normal TV

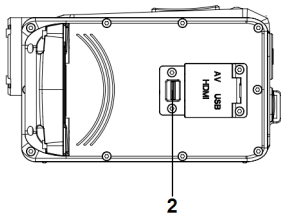

- (a) Slide the jacks cover lock (as (2) in the above drawing) to open the jacks cover.
- (b) Connect the video camera (AV out jack) with the TV via the A/V cable.
- (c) Turn on the TV and the video camera.
- (d) Set the TV at "AV" mode and the TV is now used as the display (the LCD screen on the video camera will be switched off automatically).

2. Connecting to an HDTV

When the video camera is connected to the HDTV, it can only playback files and cannot take photos, record video clips or audio files.

- (a) Slide the jacks cover lock to open the jacks cover.
- (b) Connect the video camera (HDMI port) with the HDTV via the HDMI cable (not included).
- (c) Turn on the TV and the video camera.
- (d) Set the TV at "HDMI" mode.
- (e) Set the video camera at Playback Mode.
- (f) Use UP/PLAYBACK button to view the stored files.
- (g) Use LEFT or RIGHT button to select the desired file to playback.
- (h) If a video clip or an audio file is selected, press the shutter button to start or end the playback. Or press the OK/MENU button to pause or resume the playback.

3. Connecting to a computer

- (a) Slide the jacks cover lock (as (2) in the above drawing) to open the jacks cover.
- (b) Connect the video camera (USB port) with the computer via the USB cable and "Mass Storage" will show on the LCD screen.
- (c) The stored files can be found in the "Removable Disk" in "My Computer" in the computer.

4. PC Camera

The video camera can be used as a PC camera.

- (a) Make sure the video camera is being switched off.
- (b) Press the shutter button and don't let go.
- (c) Connect the video camera with the computer via the USB cable.
- (d) Switch on the video camera and "PC Camera" will show on the video camera's LCD screen. The video camera can now be used as a PC camera.
- (e) To exit the PC camera feature, please disconnect the video camera with the computer.

Note:

If the operating system of your computer is Windows 8 or Macintosh, the PC camera feature cannot be used.

7. Software Installation

Please place the provided CD-ROM in the CD-ROM/DVD-ROM drive of your computer. Click on the CD-ROM/DVD-ROM to start the software installation.



The auto-run screen of the software is as above. Click on the preferred item to start the installation.

- MAGIX Video easy SE: For editing video clips.
- MAGIX Photo Manager: For editing photos.
- User Manual

Note:

- To use the MAGIX Video easy SE or MAGIX Photo Manager, you will be requested to make registration.
- Please do install the Quick Time Player during the installation of MAGIX Video easy SE.
- MAGIX Video easy SE or MAGIX Photo Manager can be operated

under the operating systems of Windows XP, Windows Vista, Windows 7 and Windows 8 with the following exceptions.

- (a) MAGIX Video easy SE can't record videos under the Vista 64 and Windows XP.
- (b) MAGIX Video easy SE can't record or play videos under Windows 8.

8 · Technical Specifications

Sensor	CMOS
Display	2.7" (16:9) TFT Color LCD
Focus range	Standard: 150cm ~ infinity
Aperture	F/2.8, f=5.3mm
Shutter	Electronic Shutter: 1/2 ~ 1/2000sec.
Resolution	Still Image: [12M]: 4000x3000; [10M]: 3648X2736; [9M]: 3456X2592; [8M]: 3264x2448; [7M]: 3072X2304; [5M]: 2592x1944; [3M]: 2048x1536; [2M]: 1600x1200; [VGA]: 640x480 Video: 1080P:1920x1080; 720P:1280x720; VGA: 640x480; QVGA: 320x240.

Sensitivity	Auto
White balance	Auto/Daylight/Cloudy/Fluorescent/Incandescent
Exposure control	-2EV to +2EV in 0.3/step
Continuous shooting	Yes (five photos at one shutter release)
Photo color	[Standard]/[Sepia]/[Monochrome]/[Vivid]
Self-timer	2 / 5 / 10 sec.
External storage	Supports SD/SDHC 2GB to 32GB
TV system	NTSC / PAL
Digital zoom	4X
Power Supply	Li-Ion Battery
Ambient temperature	Operating: 0° C ~ 40° C Storage: -20° ~ 60° C
Microphone	Built-in
Speaker	Built-in
Dimension	116.5x67x48mm
Weight	Approx. 215g excluding battery

Specifications are subject to change without prior notice.

Before using your camera in the water please verify that all lids and locks are tightly closed and sealed.

After using the camera in water please let it dry.

The camera should not be exposed to high temperatures and humidity differences to avoid condensation behind the lens.

Open the battery compartment only when the camera is dry.

DECLARATION OF CONFORMITY

easypix hereby declares that the product WDV1080 is in conformity to all the essential requirements of Directive 1999/5/EC. The declaration of conformity can be downloaded here:

http://www.easypix.info/download/pdf/doc_wdv1080.pdf



Only EU

easypix[®]

LIFESTYLE ELECTRONICS