

## User Manual



## **Introduction**

Features .....	1
Package contents .....	2
Camera overview .....	2

## **Getting Started**

Attaching the hand strap .....	5
Inserting the batteries .....	5
Turning the camera on and off .....	6
Inserting an SD card .....	6
Using the LCD display .....	7
Changing LCD settings .....	7
Understanding the LCD icons .....	8

## **Taking still images or videos**

Selecting the camera mode .....	11
Taking pictures .....	11
Adjusting the camera settings using the camera buttons .....	11
Using the digital zoom .....	12
Using the flash .....	12
Using the self-timer .....	13
Taking sequences .....	13
Changing the focus setting .....	14
Recording videos .....	14
Adjusting the camera settings using the menus .....	15
Using the scene settings .....	15
Setting the resolution .....	16
Setting the date stamp .....	16
Setting the white balance .....	17
Exposure Settings .....	18
Setting the encircled exposure .....	19
Setting the quality .....	20

Customizing the camera .....	21
Enabling sound effect .....	21
Setting the welcome picture .....	21
Setting the USB options .....	23
Setting the date and time .....	23
Setting the TV out .....	23
Setting the frequency .....	24
Setting the auto power off function .....	25
Setting the language .....	25
Restoring defaults .....	27
Memory Formatting .....	27
Playing games on the camera screen .....	28

**Reviewing photos or movie clips**

Zooming in .....	30
Deleting files .....	31
Protecting files .....	31
Editing images .....	32
Resizing images .....	32
Rotating images .....	32
Cropping files .....	33
Deleting a voice memo .....	34
Using the slideshow function .....	35
Setting the starting point .....	35
Setting the slideshow interval .....	36
Setting the direction .....	36
Repeating the slideshow .....	37
Starting the slideshow .....	37
Ordering prints .....	38
Using DPOF .....	38
Using Direct-Print .....	39

**Connecting to a PC or TV**

Connecting to a PC .....	41
Installing the software .....	41
Changing the USB setting .....	42
Connecting the USB cable .....	42
Connecting to a TV .....	43
Setting the output mode .....	43
Viewing images on the TV .....	44

**Appendix**

Specifications .....	45
Error Messages .....	46



# Chapter 1 Introduction

Congratulations on purchasing this digital camera. Your digital camera is compact and ergonomic and capable of taking pictures at resolutions as high as 12 megapixels (4032 x 3024 pixels, extrapolated resolution). The digital camera can also record movies and has an 8× digital zoom.

## Features

- Compact, stylish design
- Digital zoom 8×
- 5.0 megapixel high-resolution CMOS (2592 × 1944 pixels)
- Maximum resolution 12 megapixels (4032 x 3024 pixels, extrapolated resolution)
- Video capture resolution of 320 × 240, 30 fps; 640x480, 24fps
- Super Large 2.5 Inch LCD
- Voice memo
- Supports SD card media
- Built-in 32MB Memory
- Self-timer mode
- Continuous shooting mode
- Full-speed USB2.0 Port
- TV output
- Built-in microphone and speaker

## Package contents

Make sure that your package contains the following components. If anything is missing or damaged, contact your dealer immediately. Retain the packaging in case you need to ship the digital camera in the future.

- Digital camera
- Hand strap
- Quick start guide
- User manual (on CD)
- AAA batteries × 2
- USB cable
- CD-ROM including drivers and software
- Audio/Video Cable
- Recharger

## Camera overview

Familiarize yourself with the controls of the digital camera with the illustrations below.

### Front view

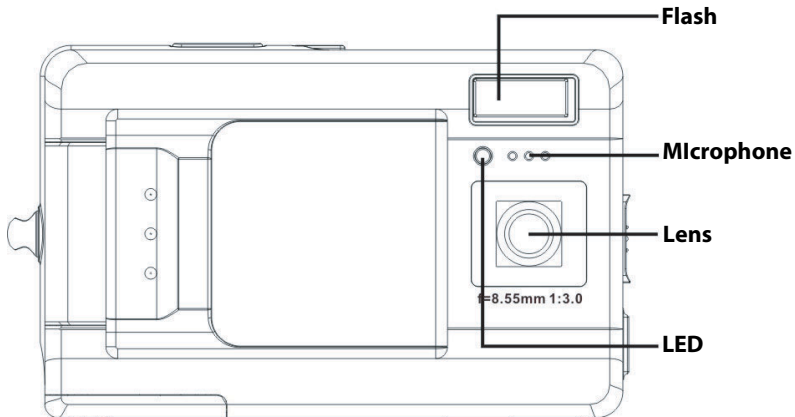



## Rear View

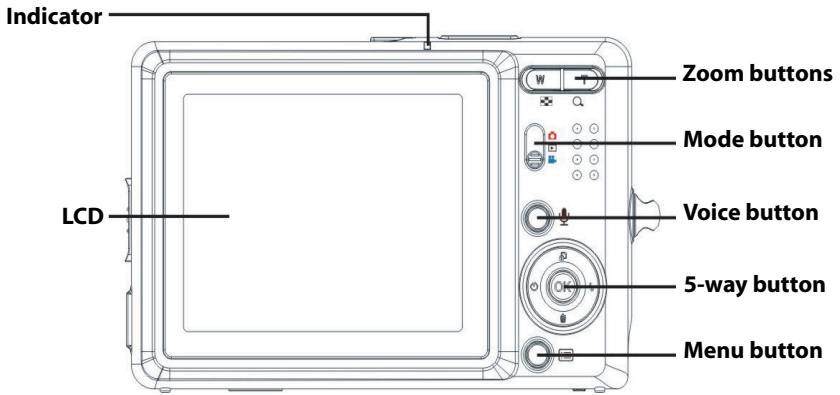

## Side Views

Right

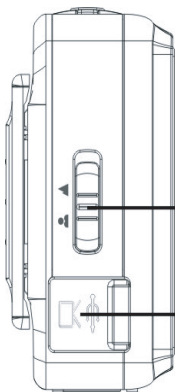

Left

Hand strap eyelet

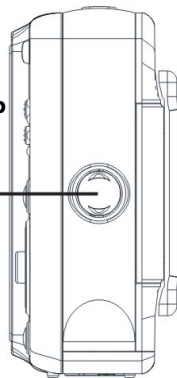

## Top View

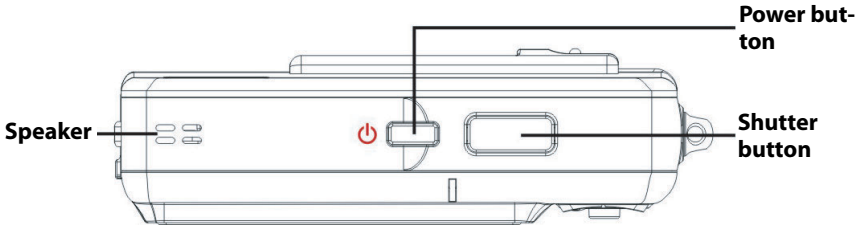

## Bottom View

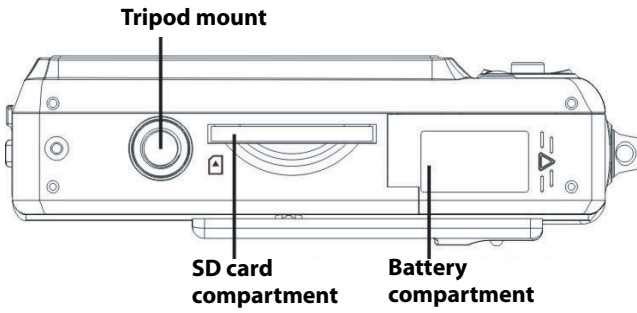

## Chapter 2 Getting Started

### Attaching the hand strap.

1. Thread the short loop of the hand strap through the hand strap eyelet on the camera
2. Thread the long loop of the hand strap through the short loop.
3. Pull the long loop tight.

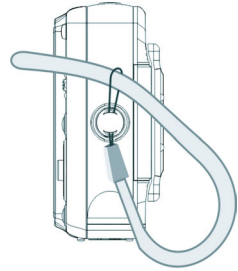

### Inserting the batteries

1. Slide the battery/memory card cover on the underside of the camera in the direction of the arrow.

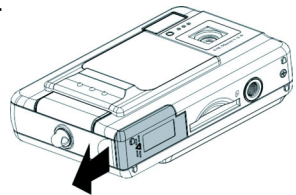

2. Open the cover.

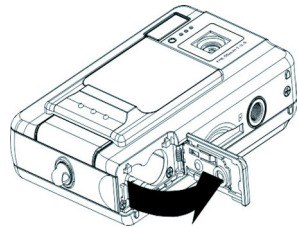

3. Insert the batteries into the compartment observing correct polarity.

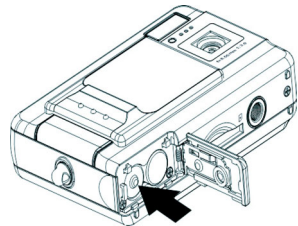

4. Close the cover and snap it into place in the direction of the arrow.

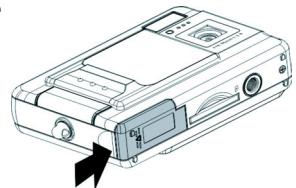

## Turning the camera on and off

Press the **Power** button on top of the camera to turn camera on.

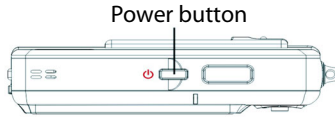

Press the **Power** button again to turn the camera off.

## Inserting an SD card

1. According to the direction indicated by the arrow, position the label on the SD card toward the front of the camera. Then push the card into the slot until it stops.

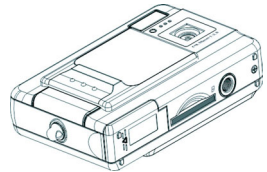
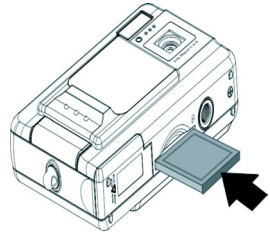

**Note:** SD cards can only be inserted facing one direction. If the card does not enter the slot easily, do not force it. Make sure the card is facing the correction direction.

## Using the LCD display

The LCD functions as a view finder, allowing you to frame pictures and video in Picture or Video mode, and view pictures and videos in Playback mode. The LCD allows you to adjust the camera's settings through the on-screen menus.

The LCD displays icons to indicate camera settings.

### *Changing LCD settings*

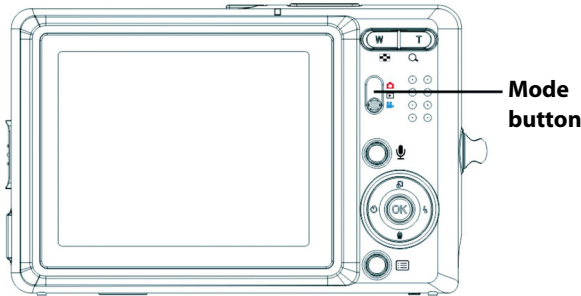

The LCD starts in normal setting. In Picture or Video mode:

- Press the **OK** button once to turn on the red framing grid.
- Press the **OK** button again to turn off the framing grid and icons.
- Press the **OK** button again to turn off the LCD.
- Press the **OK** button again turn the LCD on and display the icons.

In Playback mode:

- Press the **OK** button to turn off the icons.
- Press the **OK** button again to turn off the LCD.
- Press the **OK** button again to turn the LCD on and display the icons.

## Understanding the LCD icons

Each mode has different icons to indicate settings.

### Picture mode

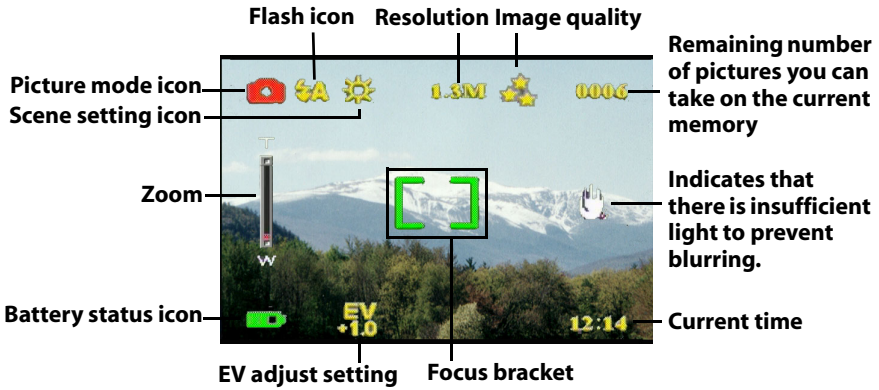

### Playback mode

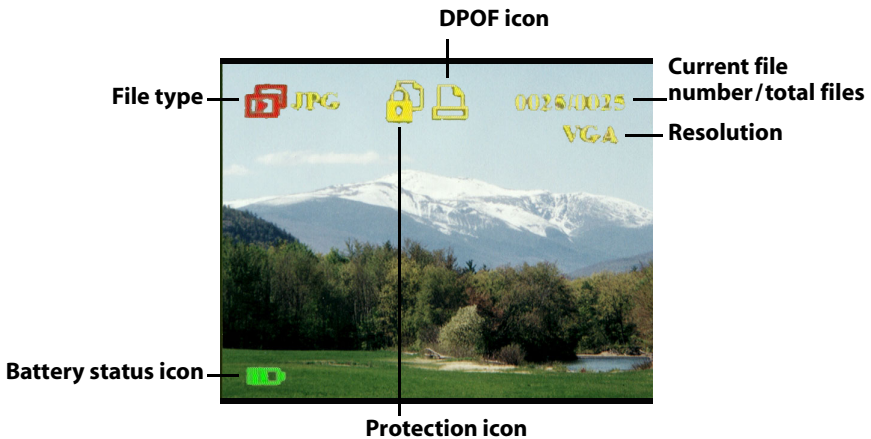

## Video mode

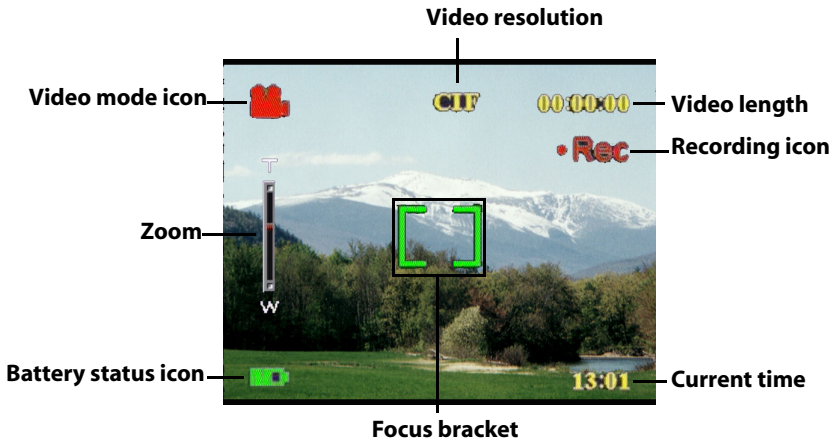





# Chapter 3 Taking still images or videos

## Selecting the camera mode

The digital camera has two capture modes: Picture and Video. Use Picture mode to capture still images and audio. Use Video mode to capture video and audio.

Use the third mode, Playback mode, to view pictures and videos, and listen to audio.

Use the **Mode** switch to change modes.

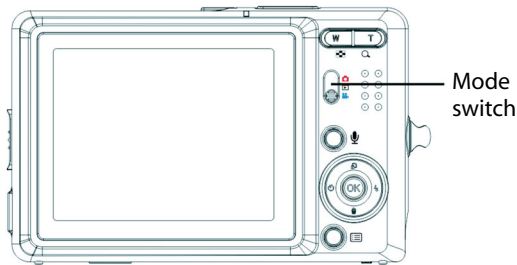

- Slide the switch to the upper position to select Photo mode.
- Slide the switch to the middle position to select Play mode.
- Slide the switch to the lower position to select Video mode.

## Taking pictures

1. Turn the camera on.  
Make sure the camera is in Picture mode.
2. Frame the picture using the LCD.
3. Press the **Shutter** button.



## Adjusting the camera settings using the camera buttons

You can use adjust the camera settings to take better pictures.

## Using the digital zoom

The camera has an 8× digital zoom, allowing you to take enlarge the subject without moving closer.

1. Turn the camera on. Make sure the camera is in Picture or Video mode.
2. Frame the picture using the LCD.
3. Press the **Zoom in** button to increase the zoom and take a close up picture of the subject with more detail. Press the **Zoom out** button to decrease the zoom and take a wider picture with less detail.
4. Press the **Shutter** button to take the picture.

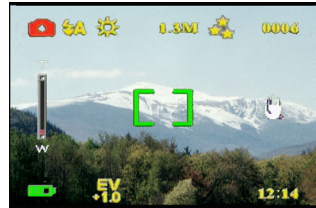

## Using the flash

The flash has three settings for different lighting conditions. Move the 5-way button left repeatedly to cycle through the different flash settings.

Icon	Description
	Flash is fired automatically if required.
	Flash is enabled.
	Flash is disabled.

## Using the self-timer

The self-timer allows you to take hands-free pictures and videos such as self portraits or group photos.

1. Turn the camera on. Make sure the camera is in Picture mode.
2. Set the camera on a stable surface such as a tripod or table and frame the picture.
3. Frame the picture, making any zoom or flash settings necessary
4. The self-timer has two delay settings.

Press the Right arrow once turn on the self-timer with a two second delay. The icon appears. Press the Right arrow again to set the delay to 10 seconds. The icon appears.



5. Press the Shutter button. The counter begins counting down on the LCD. The LED on the front of the camera flashes once a second to count down.

Note: To cancel the self timer, press the Right button until no icon is displayed.

## Taking sequences



You can take sequences of pictures very quickly one after the other using the sequence setting. You can use this to make an action series.

1. Turn the camera on. Make sure the camera is in Picture mode.
2. Press the Right arrow three times to turn on the Sequence setting. The icon appears.
3. Frame the picture using the LCD.
4. Press the Shutter button.



## Changing the focus setting

You can change the focus setting of the digital camera for different conditions. Change the setting using the Focus switch.

Icon	Description
	Adjusts the focus setting for subjects close to the lens.
	Adjusts the focus setting for subjects distant from the lens

## Recording videos

1. Turn the camera on. Make sure the camera is in Video mode.
2. Frame the picture using the LCD.
3. Press the **Shutter** button. The video begins to record.
4. Press the **Shutter** button when you have finished to stop recording.

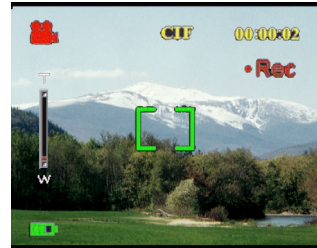

## Adjusting the camera settings using the menus

You can adjust settings using the on-screen menu. This enables you to configure the camera settings and capture pictures with optimum quality.

**Note: The LCD must be switched on to access the on-screen menu.**

### Using the scene settings

Use this menu item to specify a setting according to the light environment in which you are taking pictures. To set the scene, do the following:

1. Turn on the camera and switch to picture mode.
2. Press Menu.
3. Move the 5-way button left or right to navigate to the Capture menu (Video menu in Video mode).
4. Move the 5-way button up or down to highlight the Scene submenu.
5. Move the 5-way button right to open the Scene menu
6. Move the 5-way button up or down to select from the scene options:
  - Auto
  - Portrait
  - Scenery
  - Night scene
  - Motion
  - Couple shot
  - Sepia
  - B/W
  - Pink
  - Green
  - Blue
7. Press **OK** when finished.



**Note: In video mode, only Auto, Sepia and B/W scene options are available.**

## Setting the resolution

Use this menu item to select the resolution of the image as follows:

1. Turn on the camera and switch to picture mode.
2. Press **Menu**.
3. Move the 5-way button left or right to navigate to the **Capture** menu.
4. Move the 5-way button up or down to highlight the **Resolution** submenu.
5. Move the 5-way button right to open the **Resolution** submenu
6. Move the 5-way button up or down to select from the scene options:
  - 12.0M
  - 10.0M
  - 5.0M
  - 3.1M
  - 1.3M
  - VGA
7. Press **OK** when finished.

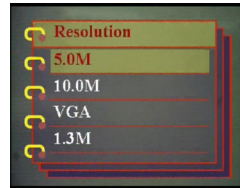
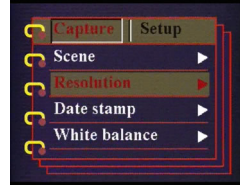

## Setting the date stamp

The date stamp menu enables you to imprint the time and the date on the image. To set the date stamp, do the following:

1. Turn on the camera and switch to picture mode.
2. Press Menu.
3. Move the 5-way button left or right to navigate to the Capture menu.
4. Move the 5-way button up or down to highlight the Date stamp submenu.
5. Move the 5-way button right to open the Date stamp menu.

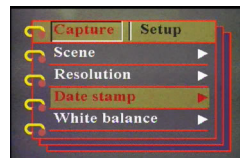

6. Move the 5-way button up or down to select from the date stamp options:
  - Date and time
  - No stamp
  - Only date
  - Only time
7. Press **OK** when finished.



## Setting the white balance

The white balance enables you to change the preset white balance setting to suit the lighting conditions in which the picture is taken.

1. Turn on the camera and switch to picture mode.
2. Press **Menu**.
3. Move the 5-way button left or right to navigate to the **Capture** menu.
4. Move the 5-way button up or down to highlight the **White balance** submenu.
5. Move the 5-way button right to open the **White balance** submenu.
6. Move the 5-way button up or down to select from the date stamp options:
  - Auto
  - Daylight
  - Cloudy
  - Tungsten
  - Fluorescent
7. Press **OK** when finished.

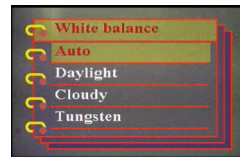
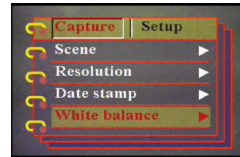

## Exposure Settings

By using the Exposure Adjusting menu, you can set the quantity of light entering into the camera when you take picture. The EV compensation is expressed as a single number that is used by the digital camera to calculate the correct combination of aperture and shutter speed for producing optimum quality pictures. Setting a higher EV compensation value will over-expose a shot while setting a lower value will under-expose a shot. Exposure can be adjusted from  $-2.0$  to  $+2.0$ . The value is shown on the LCD display. To change the EV compensation value, do the following:

1. Turn on the camera and switch to picture mode.
2. Press Menu.
3. Move the 5-way button left or right to navigate to the Capture menu.
4. Move the 5-way button up or down to highlight the EV adjust submenu.
5. Move the 5-way button right to open the EV adjust submenu.
6. Move the 5-way button up or down to adjust the EV value between  $-2.0$  through  $+2.0$ . Select Normal for the default value.
7. Press OK when finished.

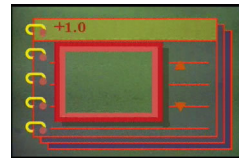
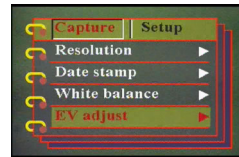



## Setting the encircled exposure

Use the following procedure to set the encircled exposure:

1. Turn on the camera and switch to picture mode.
2. Press **Menu**.
3. Move the 5-way button left or right to navigate to the **Capture** menu.
4. Move the 5-way button up or down to highlight the **Encircled exposure** submenu.
5. Move the 5-way button right to open the **Encircled exposure** submenu.
6. Move the 5-way button up or down to select one of the following values:
  - 0.3EV
  - 0.5EV
  - 1.0EV
7. Press **OK** when finished.

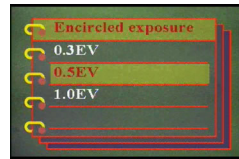
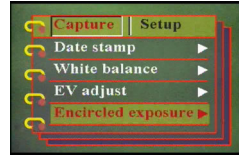

## Setting the quality

Do the following to specify the image or video quality:

1. Turn on the camera and switch to picture or video mode.
2. Press **Menu**.
3. Move the 5-way button left or right to navigate to the **Capture** menu (**Video** menu in Video mode).
4. Move the 5-way button up or down to highlight the **Image quality** submenu in the picture mode or **Video Quality** submenu in the video mode.
5. Move the 5-way button up or down to select from the quality options:
  - Picture mode
    - Basic 1:16
    - Better 1:12
    - Best 1:8
  - Video mode
    - CIF 20fps
    - CIF 30fps
    - VGA 15fps
    - VGA 24fps
6. Press **OK** when finished.

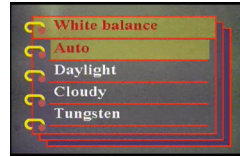
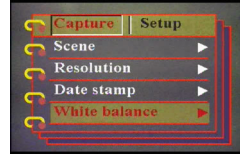

## Customizing the camera

You can customize the camera according to your preferences. Refer to the following sections for more information.

### Enabling sound effect

Do the following to enable the sound effect:

1. Turn on the camera and switch to picture mode.
2. Press **Menu**.
3. Move the 5-way button left or right to navigate to the **Setup** menu.
4. Move the 5-way button up or down to highlight the **Sound effect** submenu.
5. Move the 5-way button right to open the **Sound effect** submenu.
6. Move the 5-way button up or down to select **On** to enable the sound effect or **Off** to disable the sound effect.
7. Press **OK** when finished.

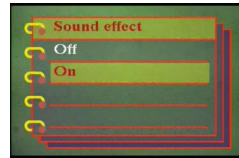

### Setting the welcome picture

Use the following procedure to specify the welcome picture shown when the camera is turned on.

1. Turn on the camera and switch to picture mode.
2. Press **Menu**.
3. Move the 5-way button left or right to navigate to the **Setup** menu.
4. Move the 5-way button up or down to highlight the **Welcome** submenu.

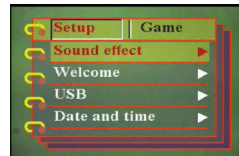

5. Move the 5-way button right to open the **Welcome** submenu
6. Move the 5-way button up or down to select one of the following options:
  - Auto
  - Off
  - Custom pic
7. Press **OK** when finished.



## Setting the USB options

Use this option to specify whether the camera is used for storage or as a web camera when connected to the PC. Refer to “Changing the USB setting” on page 42 for more details.

## Setting the date and time

Use this option to set the date and time as follows:

1. Turn on the camera and switch to picture mode.
2. Press **Menu**.
3. Move the 5-way button left or right to navigate to the **Setup** menu.
4. Move the 5-way button up or down to highlight the **Date and time** submenu.
5. Move the 5-way button right to open the **Date and time** submenu.
6. Move the 5-way button left or right to move between the various date (yy/mm/dd) and time (hh:mm) fields.
7. Move the 5-way button up or down to change the various date and time fields.
8. Press **OK** when finished.

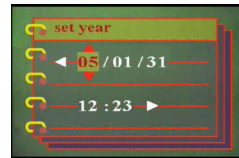

## Setting the TV out

Use this option to specify the TV out format. See “Setting the output mode” on page 43 for more information.

## Setting the frequency

Use the frequency menu to set the frequency of the camera. This value should be the same as the frequency of the power supply at the location where you are using the camera. This prevents lights flickering when taking pictures or video.

1. Turn on the camera and switch to picture mode.
2. Press **Menu**.
3. Move the 5-way button left or right to navigate to the **Setup** menu.
4. Move the 5-way button up or down to highlight the **Frequency** submenu.
5. Move the 5-way button right to open the **Frequency** submenu.
6. Move the 5-way button up or down to select 50Hz or 60Hz.
7. Press **OK** when finished.

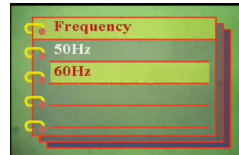
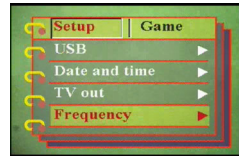

## Setting the auto power off function

The auto power off function turns off power automatically after a specified period in order to conserve power. Use the following procedure to set the auto power off interval.

1. Turn on the camera and switch to picture mode.
2. Press **Menu**.
3. Move the 5-way button left or right to navigate to the **Setup** menu.
4. Move the 5-way button up or down to highlight the **Auto power off** submenu.
5. Move the 5-way button right to open the **Auto power off** submenu.
6. Move the 5-way button up or down to select from one of the following options:
  - 1 minute
  - 2 minutes
  - 5 minutes
  - Never
7. Press **OK** when finished.

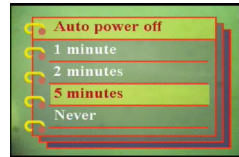

## Setting the language

To set the menu language, do the following:

1. Turn on the camera and switch to picture mode.
2. Press **Menu**.
3. Move the 5-way button left or right to navigate to the **Setup** menu.
4. Move the 5-way button up or down to highlight the **Language** submenu.
5. Move the 5-way button right to open the **Language** submenu.

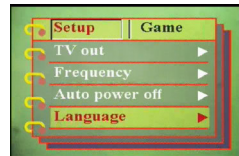

6. Move the 5-way button up or down to select from one of the following options:

- English
- German
- French
- Italian
- Spanish
- Dutch
- Czech
- Polish
- Russian
- Traditional Chinese
- Simplified Chinese
- Korean
- Japanese
- Bulgarian
- Portuguese



7. Press **OK** when finished.



## Restoring defaults

Use the setup menu to restore the camera settings to their default values as follows:

1. Turn on the camera and switch to picture mode.
2. Press **Menu**.
3. Move the 5-way button left or right to navigate to the **Setup** menu.
4. Move the 5-way button up or down to highlight the **Default** submenu.
5. Move the 5-way button right to open the **Default** submenu.
6. Move the 5-way button up or down to select **Confirm** to reset the camera or **Cancel** to cancel the operation.
7. Press **OK** when finished.



## Memory Formatting

Format the camera's memory by the following steps:

1. Turn on the camera and switch to picture mode.
2. Press **Menu**.
3. Move the 5-way button left or right to navigate to the **Setup** menu.
4. Move the 5-way button up or down to highlight the **Format** submenu.
5. Move the 5-way button right to open the **Format** submenu.
6. Press the 5-way button's UP or DOWN buttons to select OK in order to format the memory, or select Cancel to cancel the operation.
7. Press **OK** when finished. The memory of the camera is formatted. All files, including protected files, are deleted.

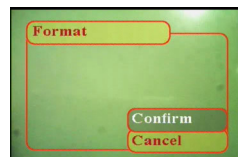
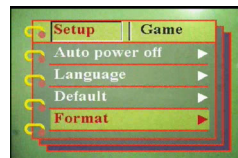

**Warning:** Memory formatting will delete all files stored in the memory. Make sure you have backed up any files you still want.

## Playing games on the camera screen

Four games are provided as an additional feature. You can use the buttons and the LCD of the camera to play games. To select a game, do the following:

1. Turn on the camera and switch to picture mode.
2. Press **Menu**.
3. Move the 5-way button left or right to navigate to the **Games** menu.
4. Move the 5-way button up or down to highlight one of the following games:
  - Magic beads
  - Lucky 777
  - Lottery
  - Boxman
  - Tiling
5. Move the 5-way button right to select the game and start playing.
6. Press **Menu** to stop the game at any time.



## Chapter 4 Reviewing photos or movie clips

Move the **Mode** switch to center to switch to playback mode.

The LCD screen displays the most recent image. If the most recent file is a video clip, it displays the first frame of the movie clip on the screen. No image is displayed if the most recent file is an audio file.

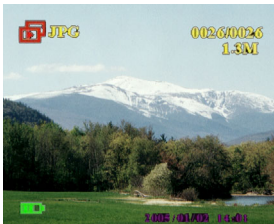
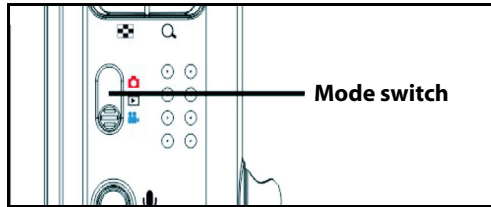
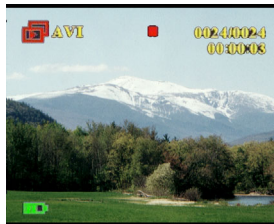
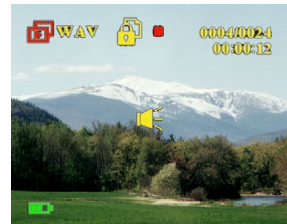

Image file



Video file



Audio file

## To browse through your images and video or audio clips, do the following:

1. Move the 5-way button right or left to skip to the next or previous file.
2. If the file is a video clip, press the **Shutter** to start playing the video clip. Press **OK** to stop playback. Playback status is displayed on the screen, along with the playback icon.
3. If the file is an audio clip, press the **Shutter** to start playing the audio clip. Press **OK** to stop playback. Playback status is displayed on the screen, along with the playback icon.
4. You can attach a voice memo to an image by pressing the **Voice** button. Press the button again to stop recording. To play a voice memo, please press the **Shutter** button. To learn about deleting the voice memo, see "Deleting a voice memo" on page 34.



## Zooming in

You can use the digital zoom feature to zoom in and examine the fine details of the picture. Press the **Zoom in** button to magnify the image and the **Zoom out** button to decrease the zoom ratio. The zoom ratio is indicated by the zoom window over the thumbnail image at the lower right corner of the screen.



The magnified image is initially centered on the LCD. To pan the view and see different parts of the magnified image, move the 5-way button left, right, up, or down. The lower right corner shows the thumbnail image along with the zoom area highlighted.



## Deleting files

In playback mode, you can easily delete any pictures or audio/video clips that you are not satisfied with, before transferring them to the PC. To delete unwanted files, do the following:

1. In playback mode, use the 5-way button to browse to the image or audio/video clip that you want to erase.
2. Move the 5-way button down to display the **Erase** menu.
3. Using the 5-way button, select one of the following options:
  - All: erases all files.
  - Current: erases the currently selected file.
  - Cancel: cancels the delete operation.
4. Press **OK** to confirm the operation. The selected files are deleted.

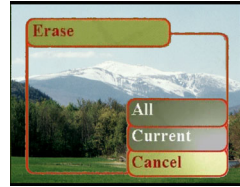

## Protecting files

To lock images or audio/video clips in order to prevent them from being deleted accidentally, do the following:

1. In playback mode, use the 5-way button to browse to the image or audio/video clip that you want to protect.
2. Move the 5-way button up to display the **Protect** menu.
3. Using the 5-way button, select one of the following options:
  - Current
  - All
  - Cancel
4. Press **OK** to confirm the operation. The selected files are protected.

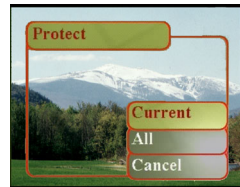

If the selected file is previously protected, the **Unprotect** menu is displayed when you move the 5-way button up. Remove the lock if required in a manner similar to protecting the image.

## Editing images

The playback menu has various options to enable you to edit pictures by resizing, cropping, or rotating. Refer to the following sections for more details.

### Resizing images

To resize an image, do the following:

1. In playback mode, use the 5-way button to browse to the image that you want to resize.
2. Press **Menu**.
3. Move the 5-way button left or right to navigate to the **Edit** menu.
4. Move the 5-way button up or down to highlight the **Resize** submenu.
5. Move the 5-way button right to open the **Resize** submenu.
6. Move the 5-way button up or down to select from the resize options: VGA, 1.3M, 3.1M, or 5.0M.
7. Press **OK** when finished.

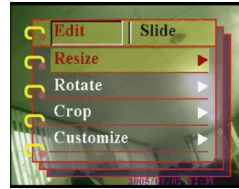

### Rotating images

To rotate an image, do the following:

1. In playback mode, use the 5-way button to browse to the image that you want to rotate.
2. Press **Menu**.
3. Move the 5-way button left or right to navigate to the **Edit** menu.
4. Move the 5-way button up or down to highlight the **Rotate** submenu.
5. Move the 5-way button right to open the **Rotate** submenu.



6. Move the 5-way button up or down to select one of the following options:
  - Rotate
  - Save
  - Cancel
7. Press **OK** when finished.

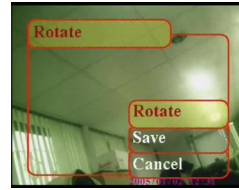

## Cropping files

The cropping feature enables you to cut off unwanted parts of the picture. To crop an image, do the following:

1. In playback mode, use the 5-way button to browse to the image that you want to crop.
2. Press **Menu**.
3. Move the 5-way button left or right to navigate to the **Edit** menu.
4. Move the 5-way button up or down to highlight the **Crop** submenu.
5. Move the 5-way button right to open the **Crop** submenu.
6. Move the 5-way button up or down to select one of the following options:
  - 4:3
  - 3:2
7. Move the 5-way button right to start cropping.
8. The cropping window is displayed on the image. Use the 5-way button to move the cropping window and select the area to be cropped.
9. Press **OK** when finished.



## Deleting a voice memo

You can use the playback menu to delete a voice memo attached to an image. To delete a voice memo, do the following:

1. In playback mode, use the 5-way button to browse to the desired image with a voice memo.
2. Press **Menu**.
3. Move the 5-way button left or right to navigate to the **Edit** menu.
4. Move the 5-way button up or down to highlight the **Voice Memo** submenu.
5. Move the 5-way button to open the **Voice memo** submenu.
6. Select **Delete** to delete the voice memo attached to the image or select **Cancel** to cancel the operation.
7. Press **OK** when finished.

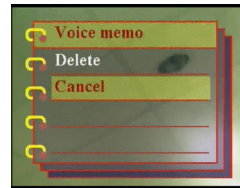
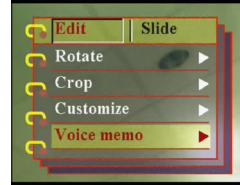



## Using the slideshow function

The slideshow feature of the camera enables you to view all the images automatically on the LCD screen. You can set the slideshow interval, direction, etc. and customize the slideshow as required.

**Note: Audio/video clips are not played back during the slide show. The first frame of the video clips are displayed during the slide show.**

Refer to the following sections to set up a slide show.

### Setting the starting point

To specify the starting point of the slide show, do the following:

1. Press **Menu**.
2. Move the 5-way button left or right to navigate to the **Slide** menu.
3. Move the 5-way button up or down to highlight the **Show** submenu.
4. Move the 5-way button right to open the **Show** submenu.
5. Move the 5-way button up or down to select one of the following options:
  - From current
  - From first
  - From last
6. Press **OK** when finished.

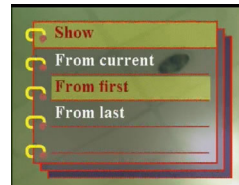

## Setting the slideshow interval

To set the interval between consecutive images during the slide show, do the following:

1. Press **Menu**.
2. Move the 5-way button left or right to navigate to the **Slide** menu.
3. Move the 5-way button up or down to highlight the **Interval** submenu.
4. Move the 5-way button right to open the **Interval** submenu.
5. Move the 5-way button up or down to select one of the following options for the interval:
  - 1 sec
  - 3 sec
  - 5 sec
6. Press **OK** when finished.

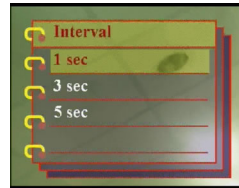

## Setting the direction

To specify the order in which the slide show displays the images, do the following:

1. Press **Menu**.
2. Move the 5-way button left or right to navigate to the **Slide** menu.
3. Move the 5-way button up or down to highlight the **Direction** submenu.
4. Move the 5-way button right to open the **Direction** submenu.
5. Move the 5-way button up or down to select one of the following options:
  - Backward
  - Forward
6. Press **OK** when finished.

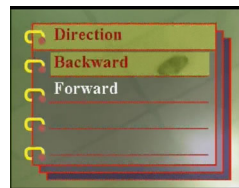
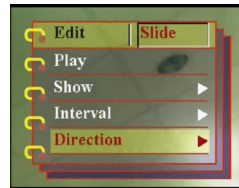

## Repeating the slideshow

To loop the slideshow repeatedly, do the following:

1. Press **Menu**.
2. Move the 5-way button left or right to navigate to the **Slide** menu.
3. Move the 5-way button up or down to highlight the **Repeat** submenu.
4. Move the 5-way button right to open the **Repeat** submenu.
5. Move the 5-way button up or down to select **Yes** to repeat the slideshow or **No** to display the slide show only once.
6. Press **OK** when finished.

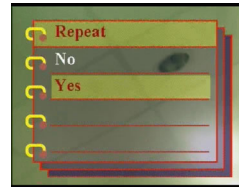
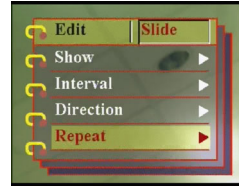

## Starting the slideshow

After setting up the slide show, you are now ready to start the slide show. To start the slide show, do the following:

1. Press **Menu**.
2. Move the 5-way button left or right to navigate to the **Slide** menu.
3. Move the 5-way button up or down to open the **Play** submenu.
4. Press **OK**. The slide show starts. Press the **OK** button at any time to stop the slide show.

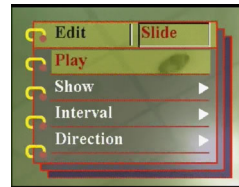

## Ordering prints

You can set up printing information for printing the digital images taken with your digital camera. Refer to the following sections for more information:

### Using DPOF

The DPOF (Digital Print Order Format) refers to a format that is used for recording the print specifications of images. Use the following procedure to set the DPOF information for a selected image.

1. In playback mode, use the 5-way button to browse to the desired image.
2. Press **Menu**.
3. Move the 5-way button left or right to navigate to the **Print** menu.
4. Move the 5-way button up or down to highlight the **DPOF** submenu.
5. Move the 5-way button right to open the **DPOF** submenu.
6. Use the 5-way button to select **Current** to set the DPOF information for the current image or **Reset** to clear the DPOF information for the image.
7. Press **OK**.

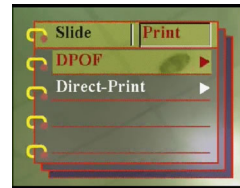

The DPOF information is stored with the image as indicated by the DPOF icon. This information enables you to take prints for the image from a DPOF-compatible printer.

## Using Direct-Print

You can also connect a printer to the digital camera using the USB port and take prints directly. To set the number of prints for an image, do the following:

1. In playback mode, use the 5-way button to browse to the desired image.
2. Press **Menu**.
3. Move the 5-way button left or right to navigate to the **Print** menu.
4. Move the 5-way button up or down to highlight the **Direct-Print** submenu.
5. Move the 5-way button right to open the **Direct-Print** submenu.
6. Use the 5-way button to select **Current** to print the current image or **Cancel** to cancel the operation.
7. Press **OK**.
8. Use the 5-way button to select the **Copies** option and set the number of copies to be printed by moving the button left or right.
9. Select the **Print** option and press **OK** to start printing.

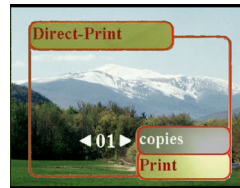
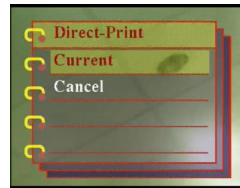
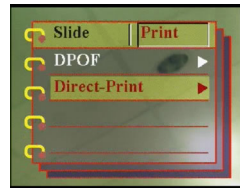



## Chapter 5 Connecting to a PC or TV

This chapter describes how to connect the digital camera to a TV for reviewing your pictures and videos, or to a PC to transfer your files.

### Connecting to a PC

You can connect your camera to a PC via the USB port and transfer photos to the PC. You can also use the camera as a web camera and use it for video conferencing. Refer to the following sections for more information.

### Installing the software

The software CD provided with the digital camera contains the software driver required to use the camera as a web camera and to transfer data from it. It also contains various software applications to help you view and edit your digital photos and videos. To install the software, do the following:

1. Insert the CD into your PC's CD drive. The CD menu is displayed.
2. Select one of the following options:
  - Digital Camera Driver
  - Ulead Photo Explorer 8.0SE
  - Ulead Video Studio 7.0SE
  - Ulead Cool 360
  - Acrobat Reader
  - User Manual
3. Click **Install** to start the installation. Follow the instructions on the screen to complete the installation.

## Changing the USB setting

You can use the camera as a storage device and transfer the photos to the PC. You can also use it as a web camera for video conferencing. To configure the USB setting, do the following:

1. In picture mode, press **Menu** to display the menu.
2. Move the 5-way button left or right to navigate to the **Setup** menu.
3. Move the 5-way button up or down to highlight the **USB** submenu.
4. Move the 5-way button right to open the **USB** submenu.
5. Move the 5-way button up or down to select one of the following options:
  - Storage
  - PC camera
6. Press **OK** when finished.

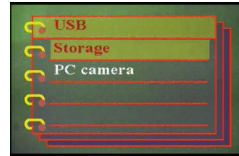
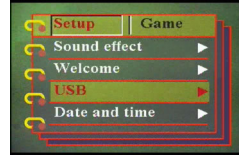

## Connecting the USB cable

To connect the camera to the PC, do the following:

1. Turn on the camera.
2. Connect the digital camera to the computer with the USB cable.
3. The LCD displays Memory or Camera and Close. All camera buttons are disabled.

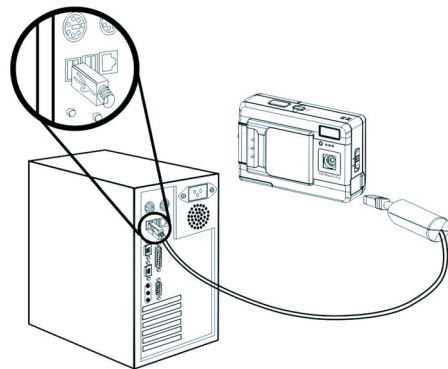



## Connecting to a TV

You can connect the digital camera to a TV and use the TV screen to review your images and play back your video clips.

### Setting the output mode

Before connecting the camera to a TV, you need to set the TV output mode and make sure it matches that of your TV. To set the TV output mode, do the following:

1. In picture mode, press **Menu** to display the menu.
2. Move the 5-way button left or right to navigate to the **Setup** menu.
3. Move the 5-way button up or down to highlight the **TV out** submenu.
4. Move the 5-way button right to open the **TV out** submenu.
5. Move the 5-way button up or down to select the **NTSC** or **PAL** option.
6. Press **OK** when finished.

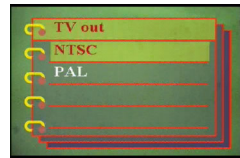

## Viewing images on the TV

To view images and videos on the TV, do the following:

1. Turn the camera on and set it to playback mode using the mode switch.
2. Connect the TV out jack on your digital camera to the audio / video input ports on your TV using the AV cable provided. The LCD screen turns off.
3. Use the procedures described in "Reviewing photos or movie clips" on page 29 to play back the files on your camera.

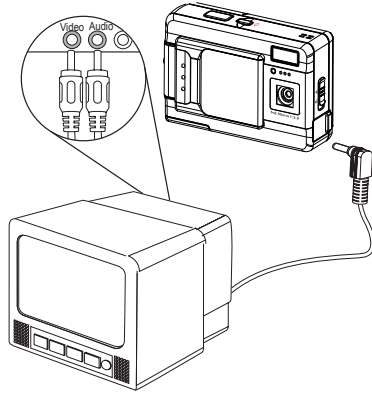

**Specifications**

Image sensor	1/1.8-inch CMOS
Resolution	5 megapixels (2592 × 1944 pixels)
Extrapolated resolution	12 megapixels
Shutter speed	1/4 ~ 1/1000 second
Zoom	8× digital zoom
LCD	2.5 Inch TFT
Internal memory	32 MB SDRAM
Supported media	Secure Digital card
Image	JPEG/EXIF 2.1/DPOF
Video	AVI (CIF)
Audio	WAV
Connections	USB 2.0
Power	2 × AAA batteries
Weight	85 g

## Error Messages

Error Message	Possible causes	Solutions
Card Full	The card is full, and no more files can be stored on the card.	Delete some files or insert another card.
Write-Protect	Card has been write protected.	Move the card's write protect switch to turn off write protection
Card Error	<ul style="list-style-type: none"> <li>• The card maybe damaged.</li> <li>• The card may require formatting.</li> </ul>	<ul style="list-style-type: none"> <li>• Format the card</li> <li>• Insert another card.</li> </ul>
Picture Error	The picture cannot be viewed with the camera	View the image on a computer. If the picture cannot be viewed, the file may be damaged.
No picture	There are no files on the memory or card.	<ul style="list-style-type: none"> <li>• Take pictures or video.</li> <li>• Insert another card.</li> </ul>
Card Setup	The card is not formatted	Format the card.
Battery Empty	Battery does not have sufficient charge for camera to operate.	<ul style="list-style-type: none"> <li>• Replace batteries.</li> <li>• Recharge batteries.</li> </ul>