

## **Preface**

Congratulations on your purchase of this advanced digital camera, with capabilities of a video recorder and music player. Ensure that you read this manual carefully and keep it in a safe place for future reference.

## **About this manual**

Every effort has been made to ensure that the contents of this manual are correct and up-to-date. However, no guarantee is made regarding the accuracy of the contents, and the manufacturer reserves the right to make changes without notice.

## **Copyright**

© Copyright 2007.

All rights reserved. No part of this publication may be reproduced, transmitted, transcribed, stored in a retrieval system or translated into any language or computer language, in any form or by any means, electronic, mechanical, magnetic, optical, chemical, manual or otherwise, without the prior written permission of the manufacturer.

## Safety

- Do not use or store the product in dusty, dirty, or sandy areas, as its components may be damaged.
- Do not store the product in hot areas. High temperatures can shorten the life of electronic devices, and warp or melt certain plastics.
- Do not store the product in cold areas. When the product warms up to its normal temperature, moisture can form inside, possibly damaging the electronic circuits.
- Do not attempt to open the casing.
- Do not drop or knock the product. Rough handling may damage the internal components.
- Do not use harsh chemicals, cleaning solvents or strong detergents to clean the product. Wipe the product with a soft cloth slightly dampened.
- If the product or any of its accessories are not working properly, take them to your nearest qualified service center. The personnel there will assist you, and if necessary, arrange for the product to be repaired.

# Table of contents

Preface .....	i
About this manual .....	i
Copyright .....	i
Safety .....	ii
<b>Getting started .....</b>	<b>1</b>
Checking the accessories supplied .....	1
1 Camera parts .....	2
2 Rotating the LCD monitor .....	5
3 Inserting the battery .....	5
4 Inserting an SD card (not supplied) .....	6
5 Turning on/off the camera .....	7
6 Charging .....	8
<b>Basic settings .....</b>	<b>9</b>
1 Language preference setting .....	9
2 Date and time setting .....	9
3 Formatting internal memory / SD Card .....	9
<b>Image shooting .....</b>	<b>10</b>
1 Basic shooting .....	10
2 Using the zoom .....	10
3 Using the self-timer .....	10
4 Basic function buttons .....	11
<b>Image viewing/deleting .....</b>	<b>13</b>
1 To view images .....	13
2 To view an enlarged image (playback zoom) .....	13
3 To delete images .....	13
<b>When shooting still images .....</b>	<b>14</b>
1 Indicators on the screen (Preview mode) .....	14
2 Photo setting menu .....	15
<b>When shooting a video .....</b>	<b>18</b>
1 Indicators on the screen (Video recording mode) .....	18
2 Video setting menu .....	19
<b>How to use mode function .....</b>	<b>20</b>
Mode table .....	20
<b>Picture mode .....</b>	<b>21</b>

1 Indicators on the screen (Picture mode)	21
2 When viewing an image	21
3 Picture mode setting menu	22
<b>Video mode</b>	<b>25</b>
1 Indicators on the screen (Video mode)	25
2 When viewing a video	25
3 Video mode setting menu	26
<b>Audio mode</b>	<b>27</b>
1 Indicators on the screen (Audio mode)	27
2 When listening to an audio clip	27
3 Audio mode setting menu	28
<b>Voice recorder mode</b>	<b>29</b>
1 Indicators on the screen (Voice recorder mode)	29
2 How to record a voice clip	29
<b>E-book mode</b>	<b>30</b>
1 How to import E-book files into the camera	30
2 When reading an E-book	30
3 E-book mode setting menu	30
<b>Music mode</b>	<b>32</b>
1 Indicators on the screen (Music mode)	32
2 How to import music files into the camera	32
3 When playing music files	33
4 Music mode setting menu	33
<b>Setting mode</b>	<b>35</b>
<b>Connecting to your computer</b>	<b>38</b>
1 Installing software	38
2 Connecting through USB	38
<b>Viewing images on TV screen</b>	<b>40</b>
<b>Precaution</b>	<b>41</b>
<b>Appendix</b>	<b>42</b>
LED Status	42
Specifications	43

# Getting started

---

## Checking the accessories supplied

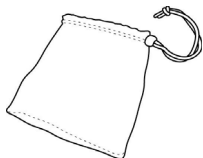

**Pouch**



**Strap**



**Battery**

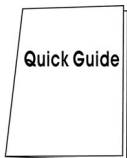

**Quick Guide**

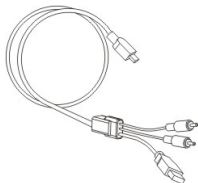

**Composite Video  
Cable**



**Earphone**

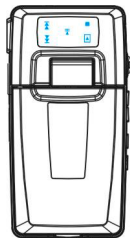

**Camera**



**CD-ROM (Includes User Manual)**

# 1 Camera parts

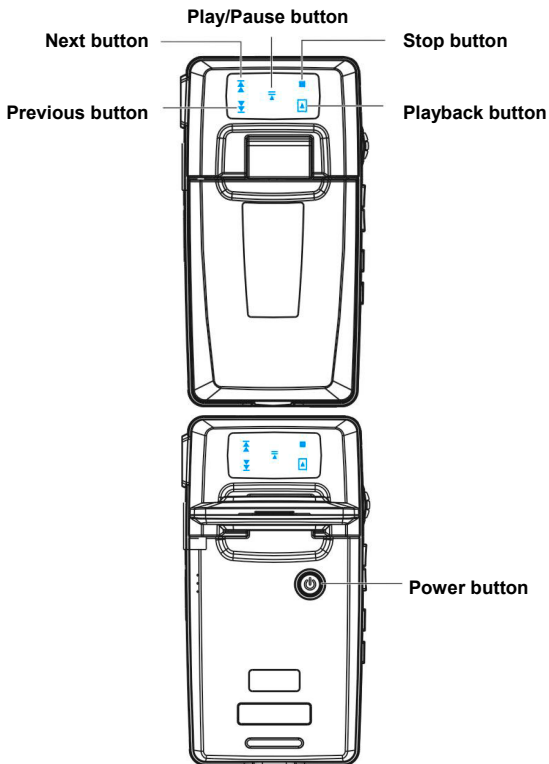

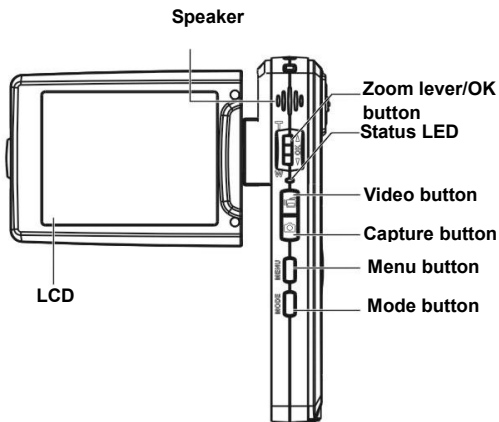
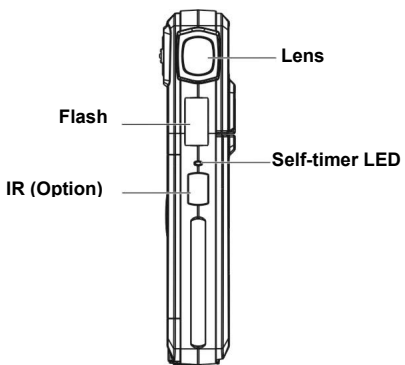

**SD card door**

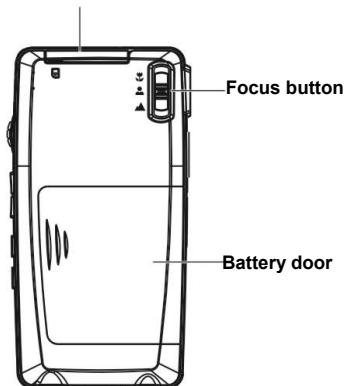

**Microphone**

**Hand Strap buckle**

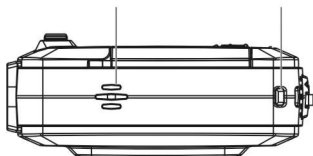

**Earphone hole**

**USB/TV-out jack**

**Tripod nut**

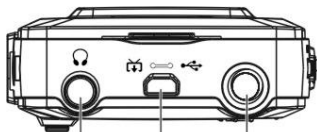



## 2 Rotating the LCD monitor

Open the LCD monitor carefully.

The directions and lock position of the LCD monitor is shown as follows:

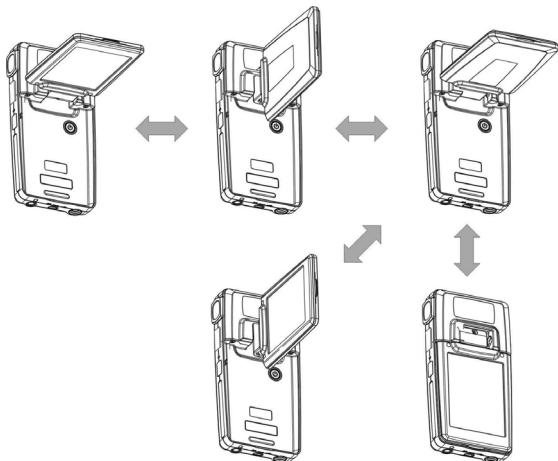

## 3 Inserting the battery

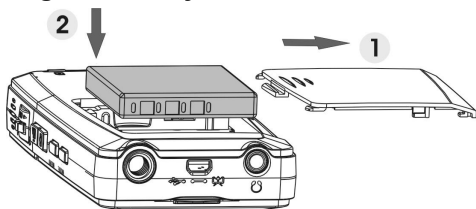

1. Open the battery door.
2. Load the included battery into the battery compartment.
3. Close the battery door.

## 4 Inserting an SD card (not supplied)

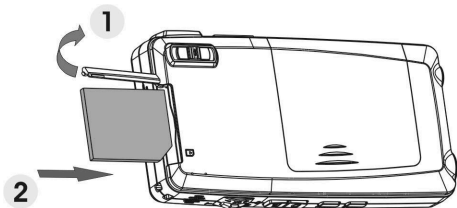

1. Open the SD card door.
2. Insert the SD card (not supplied) all the way until it clicks.
3. Close the SD card door.

### ***CAUTION!***

Use only the specified battery for this camera. Other power sources may cause a fire.

The battery should be inserted in the battery compartment with the ends orientated correctly.

### ***NOTE:***

1. Upon loading a new battery, users will need to reset their Basic Settings.
2. Do not open the battery door or remove the battery when the camera is in the ON state. Only remove the battery and SD card when the camera is not in use, or in its OFF state.
3. If you do not plan to use the camera for a long period of time, please remove the battery and SD card.
4. In order for the Li-Ion battery to achieve optimum performance it is highly recommended to charge the battery at least 8 hours before first use or after storage for more than 3 months.

## 5 Turning on/off the camera

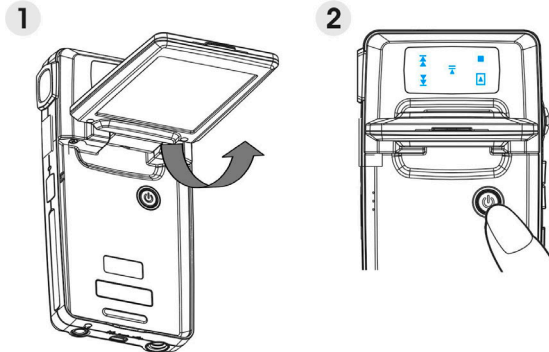

There are two ways to turn on/off the Camera:

1. Open or close the LCD monitor.
2. Press and hold the Power button.

## 6 Charging

1. Simply use the composite cable in the package to connect the Camera and your PC, and the charging process will be started.

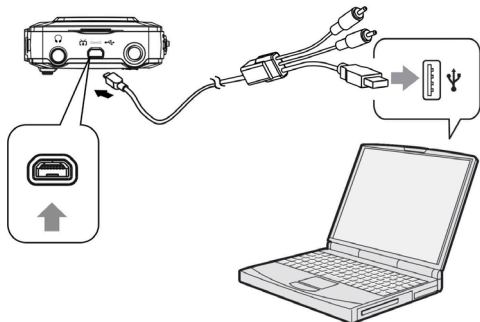

2. Connect the AC-adaptor and the camera with the composite cable, and then plug the adapter to the wall outlet.

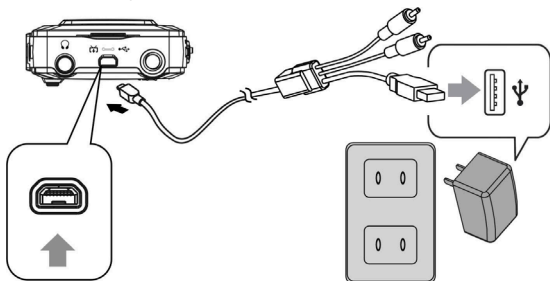

# Basic settings

---

## 1 Language preference setting

There are a total of fifteen languages to choose from. Please refer to the **Language** setting function. (Page 37)

## 2 Date and time setting

Please refer to the **Date and Time** setting function. (Page 36)

## 3 Formatting internal memory / SD Card

To take pictures more effectively, format the content of the Internal Memory/SD card. To format the SD card, please insert a compatible SD card into the SD slot. Then perform the following steps:

1. Enter the Menu Setting Function.
2. Select the "**Format**" setting option from the menu using the zoom lever.
3. Choose "**Confirm**" and then press the OK button to process.

### ***NOTE:***

Formatting irrevocably erases all data in the internal memory or on the SD card, including even protected images.

# Image shooting

---

This Quick Start provides simple and basic directions to get you shoot image or video easily. For an in-depth description of image shooting, please refer to page 14.

## 1 Basic shooting

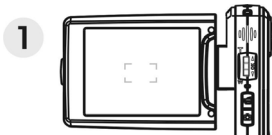

- (1) Looking into the LCD and try to align your subject into the focus brackets.

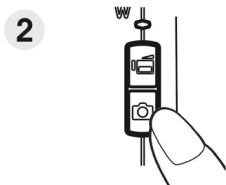

- (2) Shoot with the shutter button:
- **Still image:**  
When your subject has been aligned for shooting, press the **Capture** button to take picture.
  - **Video:**  
Press the **Video** button.  
To stop recording, press the video button again.

## 2 Using the zoom

This function works in both **DSC** and **DV** mode.

This camera has an 8x digital zoom function; there is a zoom bar on the left side of LCD display to indicate the zoom status. Push the zoom lever up (**T**: Zoom in) to get closer to the subject, or down (**W**: Zoom out) to move away from the subject.

## 3 Using the self-timer

Press the OK button to set a delay between the moment you press the shutter

and the moment the picture is actually captured.

Press the **Capture** button, the self-timer lamp flashes until the shutter operates.

 **3 3 sec** Setting the 3-second delay self-timer.

 **10 10 sec** Setting the 10-second delay self-timer.

**NOTE:**

This function works only in DSC mode.

## 4 Basic function buttons

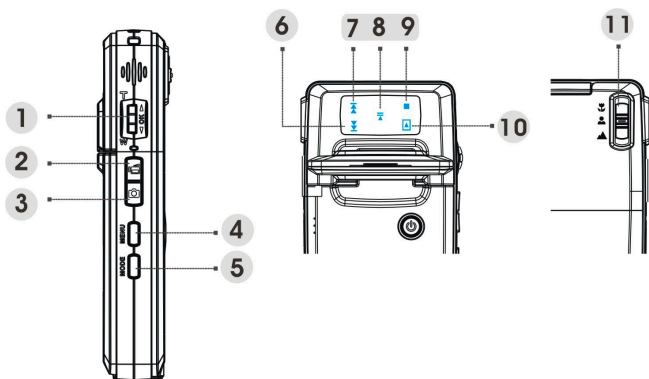

(1) Zoom lever (T: zoom in/W: zoom out)

i. Use to zoom in/out.

ii. Use to play fast forward or fast backward when playing a video clip.

iii. Push up/down to navigate the OSD menu.

OK button Press to execute items.

(2) Video button Press to start/stop video recording.

(3) Capture button

- i. Use to take an image.
- ii. Use to record or play a 20s voice memo in Picture mode.

(4) Menu button Use to enter/exit setting menu

(5) Mode button

- i. Use to enter **Mode** menu.
- ii. Use to return to the previous menu or mode.

**Touch buttons (6)~(10):**

(6) Back button

- i. Use to play fast backward (2X, 4X, 8X, 10X) when playing a video clip.
- ii. Use to play previous file in **Music** or **Audio** mode.
- iii. The same function as push the zoom lever down.

(7) Next button

- i. Use to play fast forward (2X, 4X, 8X, 10X) when playing a video clip.
- ii. Use to play next file in **Music** or **Audio** mode.
- iii. The same function as push the zoom lever up.

(8) Play/Pause button

- i. Use to play or pause, when playing a Music or voice clip in Music or Voice playback mode.
- ii. Use to execute items.
- iii. Use to record a 20s voice memo.

(9) Stop button Press to stop playing when playing a Music or voice clip in **Music** or **Audio** mode.

(10) Playback button Press to return to the previous menu or mode.

(11) Focus button Push to change focus mode between Macro, Normal or Infinity.

**NOTE:**

The touch buttons are only enabled under Mode menu.



# Image viewing/deleting

---

## 1 To view images

Press the **Mode** button. Use the zoom lever to select **Picture** mode, to review the recently taken images, and push the zoom lever up or down to view previous or next image.

For an in-depth description of **Picture** mode, please refer to page 21.

## 2 To view an enlarged image (playback zoom)

Press the **OK** button, and then you can push the zoom lever up or down to zoom in or out the image.

Press the **Menu** button, and then you can use the **Video/Capture** button or the zoom lever to adjust the portion left/right or up/down.

Press the **Mode** button if you want to undo the zoom.

## 3 To delete images

When in **Picture Mode**, display the image you want to delete.

1. Press the **Menu** button.
2. Push the zoom lever up or down to select **Delete** option, and press the **OK** button.
3. Push the zoom lever up or down to select from **Current**, **All** or **Cancel** and press the **OK** button.

For an in-depth description of **Delete** function, please refer to page 22.

# When shooting still images

## 1 Indicators on the screen (Preview mode)

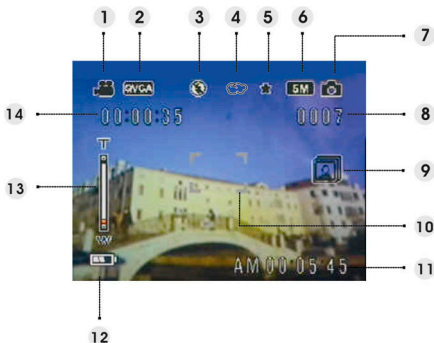

- |                               |   |
|-------------------------------|---|
| (1) <u>DV mode icon</u>       | /   |
| (2) <u>Video resolution</u>   | VGA / QVGA  |
| (3) <u>Flash mode</u>         | No flash / Auto flash / Force flash               |
| (4) <u>White balance</u>      | Auto / Daylight / Cloudy / Tungsten / Fluorescent |
| (5) <u>Image quality</u>      | Basic / Better / Best                             |
| (6) <u>Photo resolution</u>   | VGA / 1.3M / 3M / 5M / 7M / 12M                   |
| (7) <u>DSC mode icon</u>      | /   |
| (8) <u>Picture remain</u>     | /   |
| (9) <u>Photo mode</u>         | Normal / Couple shot / Continue shots             |
| (10) <u>Focus area</u>        | /   |
| (11) <u>Present time</u>      | /   |
| (12) <u>Battery indicator</u> | /   |
| (13) <u>Zoom bar</u>          | /   |
| (14) <u>DV time remain</u>    | /   |

## 2 Photo setting menu

Press the **Menu** button. Then use the zoom lever to select “DSC” option.

Press the OK button to enter the option. Push the zoom lever up/down to scroll through the choices and press the OK button to confirm the setting change.

Press the **Mode** button to return to the previous menu.

Press the **Menu** button again to exit the menu at any time.

### ▪ Flash mode

Use this option to set a proper flash mode. Users can select from the following four modes:

**No flash** Flash forced off

**Auto Flash** Strobes when there is insufficient light or backlight (default setting)

**Force flash** Flash forced on



### ▪ Scene

Users can select from the following scene settings to suit the environment for still image shooting:

Auto / Portrait / Landscape / Night / Sport / Self portrait / Night Portrait / Sunset / Beach / Autumn / Nature / Backlight / Sky / Party / Sepia / BlackWhite / Red / Pink / Purple / Blue / Green / Yellow / Solarize / Negative



### ▪ Photo setting

**Normal** Normal shot.

**Couple shot** Use this option to combine two different images in one photo.

**Continue shots** Use this option to take 3 photos in one shot.

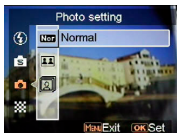

## ▪ Resolution

This setting option allows users to set the image resolution.

640 x 480	(VGA)
1280 x 960	(1.3M)
2048 x 1536	(3.0M)
2592 x 1944	(5.0M) (Default)
3072 x 2304	(7.0M)
4032 x 3024	(12.0M)



## ▪ Picture frame

Use this option to add a picture frame to your pictures when they are taken. There are 16 picture frames to choose from.



## ▪ Date Stamp

Use this option to set the date stamp shown on the images.

No stamp

Only date

Only time

Date and time



## ▪ White balance

Normally, the "Auto" WB setting will set the optimum white balance automatically. If natural colors cannot be obtained by auto WB, you can set the white balance manually to suit the particular light source. Users can select from the following white balance settings:

Auto (Default)

Sun

Cloudy



Tungsten

Fluorescent

### ▪ EV adjust

Users can adjust exposure value using this item. You can select from  $-2.0 \sim 0.0 \sim +2.0$ .



### ▪ Image Quality

Use this option to set the image quality for the picture you're going to capture. A high quality picture occupies more memory space.

Basic Economical image compression ratio.

Better Less image compression ratio.

Best Least image compression ratio (Default)



### ▪ ISO Gain

The ISO speed determines the sensitivity to light. The higher the ISO speed number, the higher the sensitivity to light.

Auto (Default)

ISO 50

ISO 100

ISO 200



# When shooting a video

## 1 Indicators on the screen (Video recording mode)

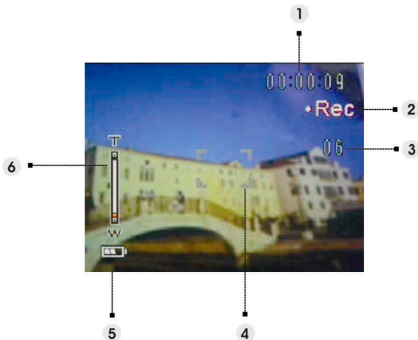

- (1) Time escape for present recording.
- (2) Recording Status icon.
- (3) Picture remains during the current recording. (Maximum: 6 photos)
- (4) Focus area.
- (5) Battery indicator.
- (6) Zoom bar.

### **NOTE:**

You can press the Capture button to take still images while recording a video clip.

## 2 Video setting menu

Press the **Menu** button. Then use the zoom lever to select “DV” option.

Press the OK button to enter the option. Push the zoom lever up/down to scroll through the choices and press the OK button to confirm the setting change.

Press the **Mode** button to return to the previous menu.

Press the **Menu** button again to exit the menu at any time.

### ▪ Resolution

This setting option allows users to set the video resolution.

QVGA

VGA



### ▪ Frame rate

Use this option to set 20 or 30 frames per second.

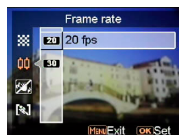

### ▪ Stabilization

Use this option to counteract camera shake and help you to shoot clearer videos.



### ▪ Monitor Video

Use this option to control your camera not to start shooting a video until the image within the focusing area is moving.



# How to use mode function

---

Please follow the instructions below:

1. Turn on the camera.
2. Press the **Mode** button to enter mode menu.
3. Push the zoom lever up or down to switch between **Picture**, **Video**, **Audio**, **Voice Recorder**, **E-book**, **Music** and **Setting** mode.
4. Press the OK button to enter.
5. Press the **Mode** button again to return to the previous menu.

## Mode table



Picture mode



Video mode



Audio mode



Voice Recorder mode

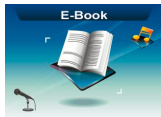

E-book mode



Music mode



Setting mode



# Picture mode

---

## 1 Indicators on the screen (Picture mode)

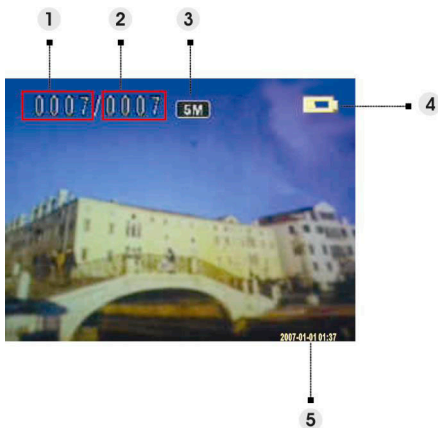

- (1) Indicates the number of the present photo
- (2) Indicates the total photo quantity.
- (3) Image resolution
- (4) Battery indicator
- (5) Date stamp

## 2 When viewing an image

1. Push the zoom lever up or down to view next or previous photo.
2. Press the **Capture** button to record a 20s voice memo or play the recorded memo of the current picture.

### 3 Picture mode setting menu

Press the **Menu** button to access the menu. Then use zoom lever to select the option and scroll through the choices. Press the OK button to confirm the setting change.

Press the **Mode** button to return to the previous menu.

Press the **Menu** button to exit the menu at any time.

#### **NOTE:**

This function will be activated only when there is at least one image file in the SD card or the internal memory.

#### ▪ **Delete**

Users can delete the current file, or all files under this option:

Current

All

Cancel

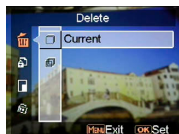

#### ▪ **Protect**

Users can prevent images from accidental erasure. This option has these settings:

Protect Current

Protect All

Unprotect Current

Unprotect All



#### ▪ **Resize**

Users can change the file size of an image. Once confirmed, the adjusted image will be saved as another image. This option has these settings:

VGA

1.3M

3.0M

5.0M



## ▪ Rotate

This option can rotate an image 90 degree clockwise or counter-clockwise.

90

270

Cancel



## ▪ Crop picture

You can crop images by specifying a desired area.

1. Use the zoom lever to reduce or magnify the image.
2. Press the **Menu** button, then you may use the zoom lever or **Video/Capture** button move the desired area up/down or left/right.
3. Once a desired section of the picture is selected, press the OK button to crop the image. (The cropped image will be saved as another image either on SD card or in internal memory)
4. Press Mode button to undo the operation.



## ▪ Customize

This option allows you to assign the present photo as the Welcome image.

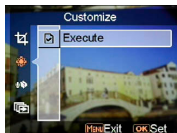

### ▪ Voice memo

Users can use this option to delete the voice memo of the current image.

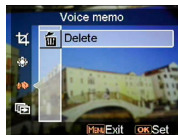

### ▪ Slide show

This setting option allows users to review all images in a slide show. Users also can set the slide show interval.

Off

3s

5s

10s



### ▪ DPOF

DPOF is a format used to record automatic printing information from this camera. By specifying which pictures are to be printed, the pictures can be printed easily by DPOF-compatible printing service labs or on a personal DPOF-compatible printer. Users can choose to print the current image or all images:

Current

Cancel



### ▪ Direct print

You can connect this camera to a printer and print images directly from the camera. Connect to a printer using the USB cable exactly the same way, as you would connect a PC. Select the Direct print option to connect to a printer when the menu appears.

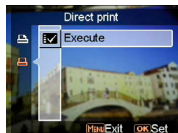

# Video mode

---

## 1 Indicators on the screen (Video mode)

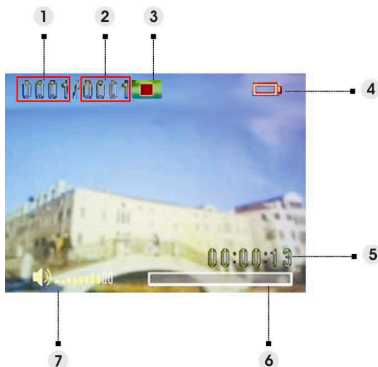

- (1) Indicates the number of the present video clip.
- (2) Indicates the total video quantity.
- (3) Play status indicator. Stop, Play, or Pause.
- (4) Battery status indicator.
- (5) Indicates the length of a video clip.
- (6) Progress bar.
- (7) Volume indicator.

## 2 When viewing a video

When viewing a video file, the first frame of the whole video will be shown on the screen.

1. Press the OK button to start playing, and touch it again to pause.
2. Press the Stop button to stop playing.
3. Use the **Capture** or **Video** button to adjust the volume.
4. Push the zoom lever up/down to choose a video or play fast forward/ fast backward when you are playing a video clip.

### 3 Video mode setting menu

Press the **Menu** button to access the menu. Then use zoom lever to select the option and scroll through the choices. Press the OK button to confirm the setting change.

Press the **Mode** button to return to the previous menu.

Press the **Menu** button again to exit the menu at any time.

#### ▪ Delete

Users can delete the current file, or all files under this option:

Current

All

Cancel

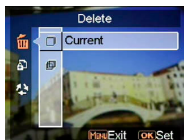

#### ▪ Protect

Users can prevent video files from accidental erasure. This option has these settings:

Protect Current

Protect All

Unprotect Current

Unprotect All



#### ▪ Continuous

Use this option to play one video or all videos continuously. This option has these settings:

Current

All

Cancel



# Audio mode

## 1 Indicators on the screen (Audio mode)

Push the zoom lever up/down to choose a clip from the play list, and then press the OK button.

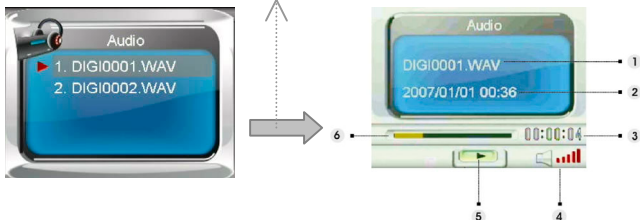

- (1) Indicates the present playing file.
- (2) Indicates the recorded date / time.
- (3) Indicates the length of the present file.
- (4) Volume indicator.
- (5) Play status indicator. **Stop**, **Play**, or **Pause**.
- (6) Playing process bar.

## 2 When listening to an audio clip

1. Press the OK button to start playing, and press it again to pause.
2. Push down the zoom lever to stop the playing.
3. Use the **Capture** or **Video** button to adjust the volume.

### 3 Audio mode setting menu

Press the **Menu** button to access the menu. Then use zoom lever to select the option and scroll through the choices. Press the OK button to confirm the setting change.

Press the **Mode** button to return to the previous menu.

Press the Menu button again to exit the menu at any time.

#### *NOTE:*

When the voice file is in whole screen mode, press the Menu button to configure the audio play settings.

#### ▪ **Delete**

Users can delete the current file, or all files under this option:

Current

All

Cancel

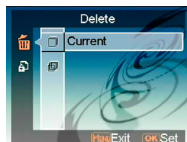

#### ▪ **Protect**

Users can prevent audio files from accidental erasure. This option has these settings:

Protect Current

Protect All

Unprotect Current

Unprotect All

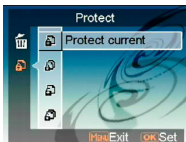



## Voice recorder mode

---

### 1 Indicators on the screen (Voice recorder mode)



- (1) Remaining recording time.
- (2) Time escape for present recording.

### 2 How to record a voice clip

1. Press the OK button to start / stop recording.
2. Push the zoom lever down to exit the **Voice recorder** mode and return to the preview mode.

# E-book mode

You can use this camera as an E-book reader.

## 1 How to import E-book files into the camera

By using the composite video cable, users can import files into the camera. Please refer to "**Connecting through USB**". (Page 38)

### NOTE:

This machine only support .txt file extension for files either in internal memory or on an SD card.

## 2 When reading an E-book

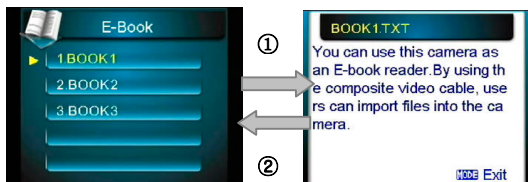

1. Push the zoom lever up or down to choose an E-book from the content, and then press the OK button. ①
2. Press the **Mode** button to return to the content. ②

## 3 E-book mode setting menu

Press the **Menu** button to access the menu. Then use zoom lever to select the option and scroll through the choices. Press the OK button to confirm the setting change.

Press the **Mode** button to back to the previous menu.

Press the **Menu** button again to exit the menu at any time.

**NOTE:**

Press the Menu button to configure the audio play settings in content mode.

▪ **Delete**

Users can delete the current file, or all files under this option:

Current

All

Cancel

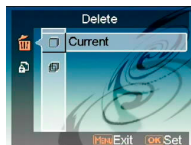

▪ **Protect**

Users can prevent audio files from accidental erasure. This option has these settings:

Protect Current

Protect All

Unprotect Current

Unprotect All



# Music mode

## 1 Indicators on the screen (Music mode)

Push the zoom lever up or down in the play list to choose the file you want to play, and then press the OK button to start playing.

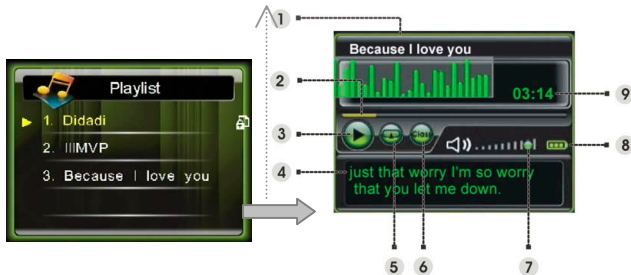

- (1) Shows the album title.
- (2) Progress bar.
- (3) Playing status.
- (4) Shows the name or the synchronized song lyrics of the playing file.
- (5) Shows present **repeat** mode.
- (6) Shows present **equalizer** mode.
- (7) Volume indicator.
- (8) Battery indicator.
- (9) Playing time of the present file.

## 2 How to import music files into the camera

By using the composite video cable, users can import music files into the

camera. Please refer to "Connecting through USB". (Page 38)

### 3 When playing music files

1. Press the OK button to pause.
2. Push the zoom lever down to stop playing, and then you can use the zoom lever to move to the next or previous music file.
3. To adjust the volume, press the **Capture** or **Video** button
4. To return to the play list, press the **Mode** button.

#### Lyric Display:

This feature only supports the lyrics of .lrc format. You can download or use the proper software to edit the lyrics. To use this feature, you just need to copy the lyrics to the Music directory of the camera when uploading the songs from the PC.

### 4 Music mode setting menu

In the file list mode, press the **Menu** button to access the menu. Then use zoom lever to select the option and scroll through the choices. Press the OK button to confirm the setting change.

Press the **Mode** button to return to the previous menu.

Press the **Menu** button again to exit the menu at any time.

#### NOTE:

This function will be activated only when there is at least one Music file in the SD card or the internal memory.

#### ▪ Delete

Users can delete the current file, or all files under this option:

Current

All

Cancel

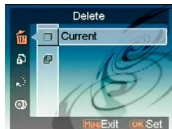

## ▪ **Protect**

Users can prevent images from accidental erasure. This option has these settings:

- Protect Current
- Protect All
- Unprotect Current
- Unprotect All



## ▪ **Play mode**

Users can set a repeat mode. This option has these settings:

- Single repeat
- Continuous
- Shuffle
- Circular



## ▪ **Equalizer**

Users can set an equalizer. This option has these settings:

- Classical
- Popular
- Rock
- Jazzy

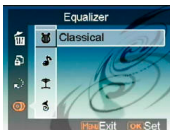

## ▪ **LCD power off**

Users can set a time before LCD automatically powers off in Music mode. This option has these settings:

- Never
- 1 min
- 3 min



# Setting mode

Press the **Menu** button to access the menu. Then use zoom lever to select the option and scroll through the choices. Press the OK button to confirm the setting change.

Press the **Mode** button to return to the previous menu.

## ▪ Sound effect

Use this option to turn on or off the sound effect of the camera.

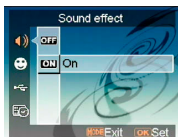

## ▪ Welcome picture

Use this option to set a welcome screen when turning the camera on.

Flash Select Flash to use the factory default flash as the welcome screen.

Picture Select Picture to use the factory default picture as the welcome screen

My photo User can use a photo as the welcome picture.



## ▪ USB mode

Use this option to set camera into the proper status when connected as a USB device.

Mass storage (Default)

PC camera



### NOTE:

1. Before connecting the camera as a PC-Camera, please install the driver on the CD-ROM first.

2. While in Mass storage mode, you can copy photo, video or audio files from your camera to the PC.

### ▪ Date and time

Use this option to set the date and time.

Push the **Capture** or **Video** button to change between fields.

Use the zoom lever to adjust the number or the format of the date.



### *Tip:*

Dates can be set in these formats:

MM/DD/YYYY DD/MM/YYYY

YYYY/MM/DD YYYY-MM-DD

Time can be set in these formats:

12-hour

24-hour

### ▪ TV system

Use this option to set the camera video output to match the TV system in your area. This option has these settings:

NTSC

PAL

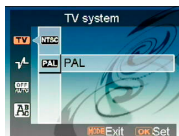

### ▪ Frequency

Use this option to set a light frequency that is suitable for your indoor lightening setting. This option has these settings:

50Hz

60Hz

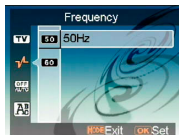



## ▪ Auto power off

Use this option to set a period of inactivity after which the camera will switch itself off. This option has these settings:

1min

3min

5min

Never



## ▪ Language

Users can select a language from the following:  
English / Simplified Chinese / Traditional Chinese /  
French / Italian / Spanish / German / Korean /  
Japanese / Russian / Polish / Czech / Dutch /  
Danish / Thai



## ▪ Default

Use this option to reset all settings to the factory default.

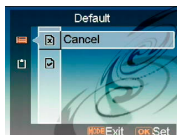

## ▪ Format

Use this option to format the data stored on the memory card or in the internal memory.

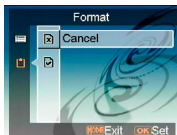

# Connecting to your computer

---

You can display images shot with the camera on the computer. Also, you can use still images and videos from the camera more than ever taking advantage of the software.

## 1 Installing software

1. Insert the CD-ROM into your CD-ROM drive.
2. The installation wizard will guide you through the installation.
3. You will be able to use the application once it's installed.

### ***Caution:***

1. **If the user didn't install the driver before plugging in a USB device, the system will detect the new device once the camera is connected to the computer. Please insert the CD-ROM and complete the drive installation.**
2. **Please install the XviD on your system, or else you may not be able to play the recorded videos on the PC.**

## 2 Connecting through USB

This section will guide users to transfer files between the camera and a PC through the USB cable (Composite Video Cable).

1. This camera allows users to move images or videos from the camera to a PC or import files from a PC into the camera using MSDC support.
2. When the camera is connected to a PC, there will be one external storage device in "My computer".

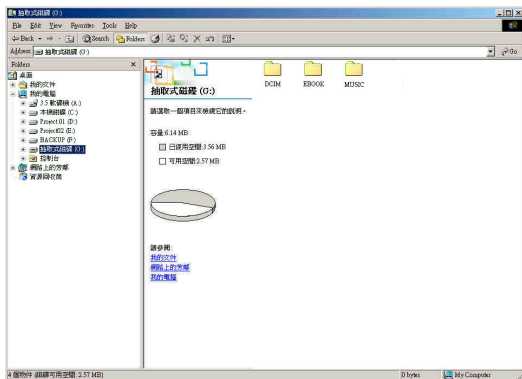

## ■ Download images or videos from your camera to a PC

1. Simply click on the folder named " DCIM\100\_FILE " to find the recorded files.
2. Copy or move these files from the camera to a PC to allow editing of the images.

## ■ Import files from a PC to your camera

1. Copy the file you want to read on your camera.
2. Simply click on the folder named "EBOOK" or "MUSIC".
3. Move the files from your PC to the corresponding folder.

## Viewing images on TV screen

---

Before connecting the camera to a TV, please set the proper TV-out protocol for the camera. (Page 36)

1. Connect the camera to the TV with the composite video cable (supplied).
2. Turn the camera on. You should then be able to operate the camera using the TV screen instead of the LCD. (The LCD will turn off when the camera is connected to the TV-out port).

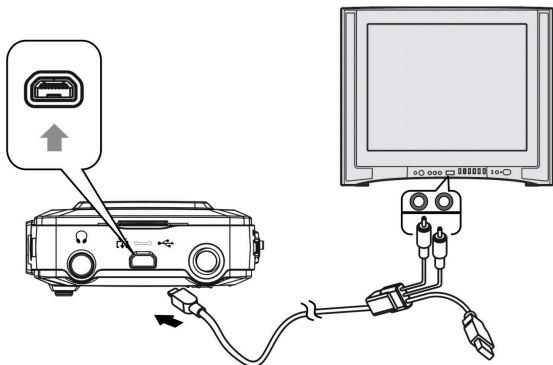

# Precaution

---

- **Internal memory and SD card back up**

Do not turn off the camera or remove the battery or SD card while the camera is processing data, as the internal memory data or data on an SD card may be destroyed. Always protect your data by making a back up copy.

- **Notes on recording/playback**

- Before you record one-time events, make a trial recording to make sure that the camera is working correctly.
- Be careful not to get the camera wet. Water entering the inside of the camera may cause malfunctions, which in some cases may not be repairable.
- Do not aim the camera at the sun or other bright light. It may cause the malfunction of your camera.
- Clean the flash surface before use. The heat of flash emission may cause dirt on the flash surface to become discoloured or to stick to the flash surface, resulting in insufficient light emission.

- **On carrying**

Do not sit down in a chair or other place with the camera in the back pocket of your trousers or skirt, as this may cause malfunction or damage the camera.

- **On cleaning**

### **Cleaning the LCD**

Wipe the screen surface with an LCD cleaning kit (not supplied) to remove fingerprints, dust, etc.

### **Cleaning the lens**

Wipe the lens with a soft cloth to remove fingerprints, dust, etc.

### **Cleaning the camera surface**

Clean the camera surface with a soft cloth slightly moistened with water, then wipe the surface with a dry cloth. Do not use the following as they may damage the finish or the casing.

- Chemical products such as thinner, benzene, alcohol, disposable cloths, insect repellent, sunscreen or insecticide, etc.
- Do not touch the camera with the above on your hand.
- Do not leave the camera in contact with rubber or vinyl for a long time.

- **On moisture condensation**

If the camera is brought directly from a cold to a warm location, moisture may condense inside or outside the camera. This moisture condensation may cause a malfunction of the camera.

### **If moisture condensation occurs**

Turn off the camera and wait about an hour for the moisture to evaporate. Note that if you attempt to shoot with moisture remaining inside the lens, you will be unable to record clear images.

# Appendix

---

## LED Status

LED Status	Status LED	Self-timer LED
Power Off	Off	Off
Power On	Green (Flick)	Off
Stand by	Green	Off
Flash charging	Red (Flick)	Off
Self-timer	Green	Flick
Music playing	Red/Green (Flick)	Off
Music pause	Green (Flick)	Off
Image saving	Green	Off
Video recording	Red/Green (Flick)	Off
USB connection	Green	Off
Charge	Red	Off
Charge OK	Off	Off

## Specifications

Features	Content
Sensor Size	1/2.5"
Sensor Type	CMOS
Maximum Image Resolution	4032 x 3024
Still Image Size	640 x 480 (VGA) 1280 x 960 (1.3M) 2048 x 1536 (3.0M) 2592 x 1944 (5.0M) (Default) 3072 x 2304 (7.0M) (Interpolation) 4032 x 3024 (12.0M) (Interpolation)
Video Clip	30fps@VGA, 20fps@VGA, 30fps@QVGA, 20fps@QVGA
Build-in Microphone	Yes
Build-in Speaker	Yes
Storage Types	Secure Digital (SD) Card, MultiMedia Card (MMC) or SD High Capacity (SDHC) Card
Digital Zoom	8x
Shutter Speed	1/6 ~ 1/4000 sec
Focus distance	Flower: 19-21cm; People: 60-120cm; Mountain: 120cm-infinity
Voice Memo	20 seconds voice memo
Audio Recording	WAV
Sound Effect	Yes
Flash Manual Setting	Off / Auto / Force On
Self-timer	3/10 seconds delay
Continuous Shot	Yes

Compressed File Format	JPEG EXIF 2.1 (DPOF support)
Video Clip Format	AVI
LCD Display	2.5" COG LCD, 640(V) x 240(H)
Multiple Language	English / Simplified Chinese / Traditional Chinese / French / Italian / Spanish / German / Korean / Japanese / Russian / Polish / Czech / Dutch / Danish / Thai
Build-in Memory	32 MB NAND Flash Memory (8MB effective)
Playback Zoom	Up to 8x
Video Out	TV out with video & audio
PC Interface	USB 2.0 High Speed
Power Source	NP-40 Lithium Ion Battery
Body Material	Plastic
Dimensions	108 x 55 x 19 (mm)
Supported O/S	Microsoft Windows 98SE, ME, 2000, XP, Vista, Mac OS 9.1 and above
Bundled software	Ulead Photo Explore Ulead Video Studio Ulead Cool 360 Adobe Acrobat Reader