

Manual

1. Get to know your DV (camera)

1.1 Features

- 3.1 Mega pixels resolution sensor
- Digital video camcorder
- Digital still camera
- Built-in flash Light
- TV output
- 1.5" LTPS real color display
- Internal 16MB flash memory and SD card support
- Driver free for Windows 2000/ME/XP/Vista and MAC 9.x and X.x
- Macro mode

1.2 Specifications

Sensor	3.1 Mega pixel CMOS sensor
Image resolution	DC
	12.0 Mega pixels: (4032x3024) (Hardware Interpolation)
	8.0 Mega pixels: (3264x2448) (Hardware Interpolation)
	5.0 Mega pixels: (2560x1920) (Hardware Interpolation)
	3.1 Mega pixels: (2048x1536)
DV	2.0 Mega pixels (1600x1200)
	1.3 Mega pixels: (1280x960)
	VGA: (640x480)
Lens	F/2.8 f=8.5mm
Focus range	0.5m. ~ Infinity
Macro mode	11cm – 18cm
Digital zoom	8x
Flash strobe	Built-in (Auto/force/off)
LCD display	1.5" real color LTPS TFT
White balance	Auto/Daylight/cloudy/Tungsten/Fluorescent
DV mode	Up to 30fps@VGA (Use SD card)
Built-in memory	16MB Flash memory
Picture Capacity in 16M memory (The quantity of pictures varies and depends on the complexity of the scene)	DC
	VGA: (640x480) -- 133Pictures
	1.3M: (1280x960) -- 63Pictures
	2.0 Mega pixels (1600x1200) -- 45Pictures
	3.1M: (2048x1536) -- 31 Pictures
	5.0M: (2560 x 1920) -- 26 Pictures
DV	8.0M: (3264x2448) -- 18 Pictures
	12M: (4032x3024) -- 12 Pictures
External memory card	SD card supports up to 2GB
File format	Picture: JPEG, Video: AVI,
Self timer	2/10/10+2 seconds
PC interface	USB 1.1
TV-out	NTSC/PAL
Power source	3xAAA alkaline batteries.

1.3 System requirement

Operating System	Windows 2000/ME/XP/Vista or above Mac 9.x or X.x
CPU	Pentium II or above
RAM	At least 64MB
Interface	USB port
CD	4x speed CD ROM or above

2. Functional parts:

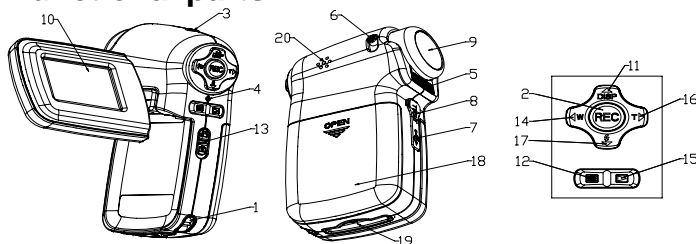

1	Strap hook	Hook for attaching the wrist strap to the camera.
2	REC	Press this button to take photographs or start/stop recording a video clip. And Press it to confirm changes.
3	Power on/off button	Press this button to turn on, press again to turn off.
4	Busy LED	When the indicator is light, the camera is busy.
5	Flash light	Use the built-in flash to give the subject extra lighting if it is in dark surroundings (the best flash distance is recommended within 1.5m.).
6	Macro switch	Macro mode: Select this mode to take close-up photographs (distance 11cm - 18cm). Normal mode: Select this mode to take photographs from 0.5m - infinity
7	USB interface	Via this connection, you can download photographs and video clips to a computer.
8	AV port	For television connection.
9	Lens	Records the image to be taken. Note: Keep the lens clean. Dirt and fingerprints will affect the quality of the picture.
10	LCD screen	Display photographs, video clips, camera setting and menu.
11	UP / display	UP and LCD display on / off
12	Menu	For camera setting.
13	Mode	Slide it to select different mode.
14	Left	For menu LEFT selection & Digital zoom in..
15	Playback	Press it to enter playback mode.
16	Right	For menu right selection & Digital zoom out.
17	Down /flash light	Down and selection of flash light mode
18	Battery door	3xAAA alkaline batteries
19	SD card slot	SD card slot.
20	Speaker	Speaker

3. Details for DV (camera) setting

DC (Camera) Capture	Size	12M pixel resolution	4032 x 3024
		8.0M pixel resolution	3264 x 2448
	Quality	5.0M pixel resolution	2560 x 1920
		3.1M pixel resolution	2048 x 1536
	Scene mode	2.0M pixel resolution	1600 x 1200
		1.3M pixel resolution	1280 x 960
	Exposure value	VGA resolution	640 x 480
		Fine(Default)/Standard/Economy	Picture quality set
	White balance	Auto(Default)	Automatic white balance
		Daylight	White balance selected for daylight surrounding
		Cloudy	White balance selected for cloudy surrounding
		Tungsten	White balance selected for tungsten lighting
		Fluorescent	White balance selected for fluorescent surrounding
	ISO	Auto(Default)/100/200	Sensitivity select
		Standard (Default) / Vivid / Sepia / Monochrome	Color setting
Saturation	Normal(Default) / High / Low	Saturation setting	
	Sharpness	Normal(Default) / Hard /Soft	Sharpness setting
Self timer	2s	Set the delay time at 2s to take a picture	
	10s	Set the delay time at 10s to take a picture	
	10+2s	Set the delay time at 10s to take a picture, and then every 2s to take pictures automatically.	
Date Input	Off(Default)/Set	DD,MM,YYYY	
Time Stamp	Off(Default)/Date Only/Date & Time	Show the date and / or time on the pictures	
Burst	Off(Default)/On	Press Shutter key to take three photos.	
DV (Video output)	Size	VGA	640 x 480
		QVGA	320 x 240
	Exposure value	Auto(Default)	Automatic white balance
		Daylight	White balance selected for daylight surrounding
	White balance	Cloudy	White balance selected for cloudy surrounding
Tungsten		White balance selected for tungsten lighting	
Fluorescent		White balance selected for fluorescent surrounding	







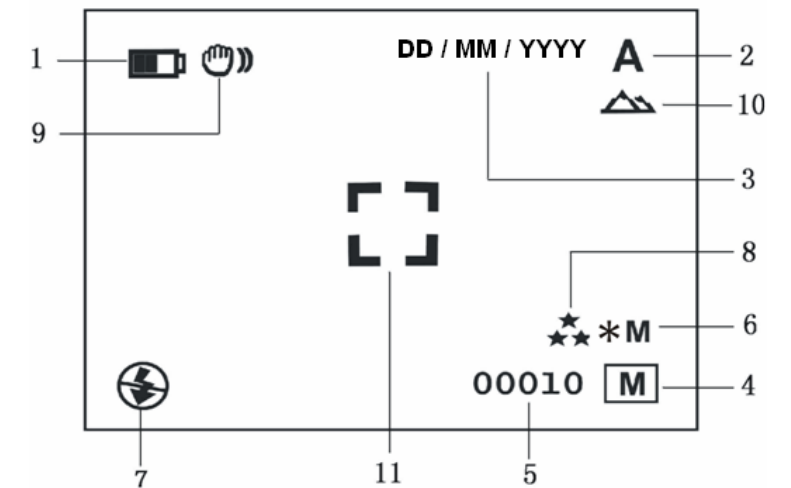

Setup	Format	Execute/cancel	Format the memory card.
	Language	English(Default)/T-Chinese/S-Chinese/French/German/Italian/Spanish/Portuguese	Select display language
	Auto power off	1/3/5 min and Off	Auto power off in 1min, 3min(default) or 5 min if no operation
	Sys. Reset	Execute/cancel	Restore default setting
	Light-Frequency (Flicker)	50Hz	Main European electricity frequency
	TV- Out	60Hz	Main American electricity frequency
	NTSC	American and Japanese video format	
	PAL	European video format.	

Note: The camera will remain the last setting when it is turned off.

4. Explanation of the status icons



Item	Function	Description
1	Battery indicator	The batteries are full. The batteries are empty.
2	Recording mode	Setting for photographs taking Setting for videos capture
3	Date stamp	Displays the date day/month/year
4	Memory or SD card indicator	Indicates memory or SD card Pictures stored in built-in memory Pictures stored in SD card
5	Photo / Video counter	Photo mode :No. of balance picture can be taken; Video mode: Balance of recording time in second; Playback mode: The No. of pictures or video file.

6	Selected Resolution	12M= 4032x3024 8M= 3264x2448 5M= 2560x1920; 3.1M = 2048x1536; 2M= 1600x1200 1.3M= 1280x960; VGA= 640x480; QVGA= 320x240
7	Flash indicator	 : Force flash.  Auto Flash: The camera determines if the flash must be used or not.  No Flash: The flash is turned off.
8	Picture quality	 The quality is fine (Default).  The quality is standard.  The quality is economy.
9	Brightness Alert	 Alert user to hold the camera steadily.
10	Normal / Macro mode indicator	 Normal mode (0.5m – infinity)  Macro mode (11cm –18cm)
11	View center	

5. Using the DV(camera)

5.1 Installing the batteries

- Open the battery door.
- Insert 3x AAA alkaline batteries into the camera.
- Turn on the DV (camera).
Press the POWER button or open the LCD panel to turn on it.

5.2 Inserting a memory card (not included)

This DV (camera) has built-in internal memory. This memory can be extended with a SD memory card (not included).

Follow the instructions given below to insert the optional SD memory card into the camera.

- Turn off the camera first.
- Insert the SD card into the camera.

Note: There is only one right direction to insert the SD memory card into the slot. Do not force the card into the slot, or else it may damage both the camera and the SD memory card.

Note: The SD memory card must be formatted before taking photographs. See the following sections for more information.

5.3 Formatting the memory or SD card

- Press Menu button
- Select Setup setting by Menu key.
- Press REC to confirm and select by up or down key.
- Press REC to format the card or memory.

5.4 Setting the resolution

The DV (camera) can be set to different resolutions.

- Press MENU to set proper resolution.

Resolution: VGA (640 x 480) , 1.3M (1280 x 960) , 2.0M (1600 x 1200) ,

3.1M (2048 x 1536), 5M (2560 x 1920), 8M (3264 x 2448), 12M (4032 x 3024)

- Different resolutions will be displayed. Select the desired resolution by using the ▲ or ▼ buttons and then press the REC button to confirm the selection.

5.5 Taking Video or photographs

- Turn on the DV (camera) .
- Slide MODE to set the DV to photo mode (A) or mode (A).
- Depending on the distance to the object being photographed, use Macro switch to adjust the distance. Select the flower symbol (A) if you wish to take a close-up photograph (11cm –18cm).
If you wish to take Video or photograph of surroundings or people (0.5m - infinity), set the Macro switch to Normal mode (A).
- If you are not sure if there is enough lighting, turn the automatic flash (A) on by pressing the flash button (A).
- Use the LCD screen to aim the object you wish to take video or photograph.
- Press REC button.

Caution: 1) Taking picture for fast-moving object is not recommended.
2) Image may be distorted when taking picture in a moving vehicle.

5.6 Zoom in and out

The DV can zoom in up to 8 times.

Zoom in or out by pressing the ◀ or ▶ button, a number will appear on the display. 8.0 is the maximum zoom.

5.7 Taking photographs using self-timer function

You can use the self-timer function when you wish to take a photograph for yourself or when you wish to photograph for an object where the camera must be as still as possible.

- Set the camera to photo mode.
- Press the MENU button. The quick menu will appear.
- Press ▼ to self-timer mode, press REC and ▲ or ▼ to set the delay time: 2seconds / 10 seconds / 10+2seconds or off.
- Press the REC button to confirm. The self-timer function is now ready for use.
- Aim at the object you wish to photograph.
- Press the REC button to take a photograph.
- The photograph will be taken after the timer reaches the delay time that you pre-set, and the camera will beep once.

5.8 Playback photographs

- Press  button to playback mode, and ▲ or ▼ to select the video clip or photo.
- Press, ◀ or ▶ to zoom the image.
- Press MENU to select SLIDE SHOW, and then press REC to confirm. The pictures saved in your camera or your SD card will be displayed in sequence automatically.

5.9 Playback video clips

- When video clips are displayed, press REC to play, and press DOWN key to stop.
- Press REC to pause the playback
- Press Playback to exit.

5.10 Delete photographs and video clips

Follow the instructions given below to delete photograph or video.

- Press PLAYBACK to enter Playback mode.
- Press the MENU button and select Delete Single/Delete All, press REC to confirm.
- If you select Protect picture, your current file or images can not be deleted.
- Press MENU to exit.



NOTE: Select 'Deleting All' and Press REC to confirm, all the pictures will be deleted.

6. Connecting the DV (camera)

The camera can be connected to the computer as Mass Storage Device,

NOTE: Under the environment with electrostatic discharge, the sample may malfunction and memory lost. It requires user re-install the battery to reset the sample.

7. Trouble shooting

Problem	Cause	Solution
Cannot turn on the DV (camera) by opening the LED panel.	Low battery power. Battery placed at wrong polarities.	Replace or install the battery correctly. Try to open the DV (camera) by pressing the power button.
Photos can not be saved when taking pictures.	The memory card or built-in memory hasn't been formatted properly.	Format the memory in SETUP mode of the camera. Please refer to section 5.3.
Cannot find removable disk after connecting the camera to the computer.	Connection failure.	Make sure all cable connections are secured and restart the computer if necessary.
Flash does not work.	Battery Power is too low.	Replace with new ALKALINE battery.
The batteries used up very fast.	Use wrong type of battery.	Replace with new ALKALINE battery.
The photos are over exposure	Set the flash light to force mode  in bright environment.	Set the Flash light to Auto mode  .
The video photos are blurry	1. The DV (camera) is not held steadily 2. The lens of DV (camera) is dirty. 3. The DV (camera) is Set to wrong macro mode.	1. Hold the DV (camera) steadily until it beeps when taking video photo. 2. Clean the lens with soft dry cloth. 3. Set the macro mode according to the distances of subject.



For EU only

AM-DV310-AGB-CLV-R