

KIDDY PIX[®]

by easypix[®]



WARNING! Not suitable for children under 36 months. Choking hazard!



easypix[®]

Keep it real.

System Requirement

Microsoft® Windows ME/2000/XP/Vista/7, Mac OS10.4 or above,
Pentium III 800MHz or above, 128MB system memory and free 500MB
system hard disk space, Available USB port; 800x600 Screen area,
16-bit color display (higher color setting recommended)

Product Specification

Image Sensor	3 Mega Pixel CMOS Sensor
Lens	F=2.6; f=5mm
Focus Range	2m~infinite
LCD monitor	1.77"/4.49cm TFT LCD (5:4 switch)
Shutter Type	Electronic
Storage Media	SD Card Slot Support up to 16 GB
Image Resolution	2048x1536
Movie Resolution	VGA 640 x 480 at 30fps
White Balance	Auto
Exposure	Auto
Interface	USB 2.0
Battery type	1.5V--AA x 2 Battery (Not included)
File Format	JPEG, AVI
Operation Modes	Still Record / Movie Record / Blast / 10s Self-Timer
Accessories	Quick installation guide, USB cable
Dimensions	90(H) x 139(W) x 52(T) mm
Weight	165g

Introduction

This camera is specially designed as the “First” digital camera for your kids. Its durable design allows your kids to experience photo taking through hands-on electronic play. It includes a USB port and cable to connect to the PC for photo viewing and editing. To ensure a truly enjoyable experience from the camera, please read the manual thoroughly and retain it for future reference. Enjoy your purchase and have a great time with your kids.

Caution! *Children using this camera must be under adult guidance at all times. Proper explanation on the correct use of the camera should be provided to them before using the camera.*

Caution! *Avoid dropping the camera or let the camera under severe vibration or impact.*

Caution! *Keep the used battery or screw out of the reach of children.*

Caution! *Do not press the surface of LCD with force, or hit it with a sharp object.*



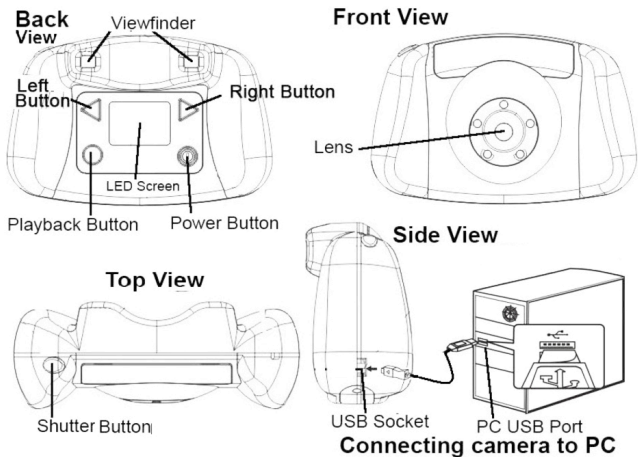

Caution! *Do not allow moisture, liquid, metal or inflammable objects to get into the camera.*

Camera Layout and Buttons:

Please refer to the following diagrams for various parts and buttons of your camera.



Usage of Control Buttons

Button	Functions
 Left	<ol style="list-style-type: none">1. To select various functions in Menu Mode.2. To zoom-out in Capture Mode.3. To select cartoon frames in Capture Mode.
 Right	<ol style="list-style-type: none">1. To select various functions in Menu Mode.2. To zoom-in in Capture Mode.3. To select cartoon frames in Capture Mode.
 Power	<ol style="list-style-type: none">1. To turn on/off the camera.2. To enter or exit the Menu Mode.
 Playback	To enter or exit the Playback Mode.
 Shutter	<ol style="list-style-type: none">1. To take pictures or record videos.2. To confirm the selection.

Getting Started

Insert SD/MMC Card into the camera:

Caution! There is no internal memory available for photo or video storage. External memory card must be inserted into camera to store photo or videos.

The memory card slot is located in the battery compartment. You need a small, cross-head screwdriver to remove the two screws located at the two ends of the battery compartment cover. Keep the two screws in a safe place so

that you can find them easily. Slide a SD card into the SD card slot (as shown on Bottom-View drawing).

Upon turning on the unit, there is a SD Card Icon appears on the LCD screen's upper-right corner. The number of pictures it can be further stored in the SD card is shown on the LCD screen's lower-right corner.

To remove the SD card, pull the SD card gently away from the card slot.

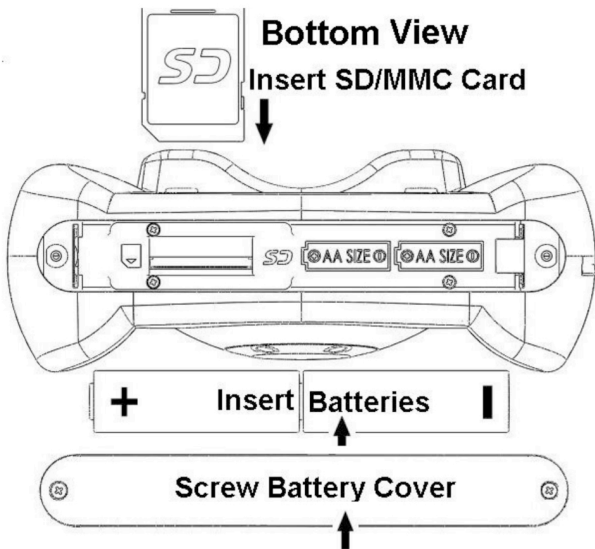

■ **Battery Installation:**

Once the battery compartment is opened and memory is inserted, place the two batteries into the battery compartment with plus (+) and minus (-) ends placed according to the orientation of the battery marks in the battery compartment. The battery compartment fits only one way. Please don't force if it does not fit, try the other way. After batteries are inserted, place the battery compartment cover to its original position. Insert the screws in their slots and tighten by the screwdriver properly.

■ **Battery Notice:**

1. The use of new alkaline or Energizer lithium batteries is recommended for maximum performance.
2. Do not mix old and new batteries.
3. Do not mix batteries of different types: alkaline, lithium, standard (carbon-zinc) or rechargeable (nickel-cadmium).
4. Remove the batteries from the unit when the unit will not be used for an extended period of time.
5. Always remove exhausted batteries from the unit.
6. Do not dispose of batteries in fire.

7. Do not attempt to recharge ordinary batteries.
8. The supply terminals are not to be short-circuited.
9. Only batteries of the same and equivalent type as recommended are to be used.

■ **Turning On/Off the Camera:**

Press Power Button to turn on the camera. You can see the startup screen on the LCD screen. Wait for a few seconds until the LCD screen shows the image captured by the lens.

If there is no memory card inserted in camera, the LCD screen will show “Insert a SD Memory Card” as a reminder.

To turn off your camera, press the Power Button again and hold it (3 seconds) until the LCD screen shows “Good Bye” and turns off.

The camera will automatically turn off if it is not used for about 60 seconds.

Taking Pictures:



After turn on the camera, objects captured by the lens can be seen on the LCD screen. Your camera is in Capture Mode and ready to take picture. Aiming at the object and then press the Shutter Button once. The LCD screen will turn into dark and then shows the picture taken for ~ 1 second. The camera will return to capture mode and ready for taking next picture. On screen's lower-right corner, it shows number (001730) of photos left to take.



In capture mode, you can zoom-in by pressing the Right Button continuously. The magnification (2.32X) will be shown on screen's left-lower corner during zoom-in. Maximum magnification can be reached is 4X. By pressing the Left Button continuously, we can return to normal mode (1X).

Cartoon Frames:

There are 10 built-in cartoon frames can be chosen as background of your pictures. In the Capture Mode, press the Right (Left) Button once, the first cartoon frame will appear on the screen. Press the Left (Right) Button once removes the cartoon frame. You can continue to press the Right (Left) button 10 times to see all of the 10 cartoon frames.



At the 11th time, the camera will go back to the Capture Mode without cartoon frame. After you select the desired cartoon frame, press the Shutter Button to take pictures.

Your pictures will then be framed by the cartoon frame.

Taking Videos:

In Capture Mode, press Power Button once brings to Menu

Mode . Press Right Button **three** times until you see

the “Video” icon . Then, press Shutter Button to return to the Capture Mode.







Your camera is now ready to take video. Press Shutter Button and camera will

start to record videos. During recording, you can see recorded time (00:00:32) on screen's lower-right corner. Press Shutter Button again to stop video recording.

Caution! When SD/MMC card is full, “**CARD FULL**” message appears on the LCD screen. Please download or erase pictures/videos to free up memory space.

Battery Icons and Power Levels: In

the Capture Mode, Battery Icon is shown on screen's upper- right corner. Attached table shows the correspondence power level for the icon. Always pay attention to the power level of the batteries.

Battery Icon	Power Level
	>70%
	>35%
	>5%
	<=5%

Caution! If camera power is low (less than 5% according to battery icon), “**LOW POWER**” message will appear on the LCD screen and camera will automatically turn off. Please change batteries according to previous instruction.

Reviewing Pictures and Videos on Camera:



In the Capture Mode, press Playback Button to enter

Playback Mode. You will see the last picture or video taken. The picture icon (JPG) or video icon (AVI) is shown on screen's upper-left corner. Press Right Button shows the first picture or video taken. Press Left Button returns to previous picture/video. On screen's lower-right corner, the sequence number of the picture (000004/000006) is shown. If the file is a video, press the Shutter Button begins the video play. Press the Shutter Button again stops the video. Press the Playback Button again returns to the Capture Mode.

Deleting Pictures/Formatting SD CARD on Camera:



To delete pictures, press the Playback Button to enter Playback Mode. Press the Left or Right Button until the photo to be deleted is displayed.

Afterwards, press the Power Button once. You can see the LCD screen as shown here. Press the Left button to select YES, then press the Shutter Button to delete the picture. The camera will return to Playback Mode once picture is deleted. You can press the Playback Button again to return to the Capture Mode.



To format the SD CARD, press the Playback Button to enter Playback Mode. Press the Power Button twice, you can see the LCD screen as shown here. Press the Left button to

select YES. Then press the Shutter Button to format the SD CARD. Once SD card is formatted, “NO FILE” is shown on the screen and you can press Playback Button to return to Capture Mode.

***Caution!* Before formatting the SD CARD in camera, make sure that all important files are saved to PC properly.**

Exploring various Functions inside the Menu Mode

■ Taking picture with Self-Timer



In Capture Mode, press Power Button once brings to Menu

Mode . Press Right

Button **once** to see the

“self-timer” icon .

Then, press Shutter Button to return to the Capture Mode. You can see the “Self-Timer” icon stays on screen’s upper-left corner.

Now you can take picture with Self-Timer. Picture will be captured 10 seconds after pressing the Shutter button.

■ Taking Multiple Pictures At Once in “Blast” mode



In Capture Mode, press Power Button once brings to Menu

Mode .

Press Left Button **twice** to see the “Blast icon” 

Then, press Shutter Button to return to the Capture Mode. You can see the “Blast” icon stays on screen’s upper-left corner. Now your camera is ready to take three pictures in a row after pressing the Shutter button.

Transferring Pictures/Videos to PC

To save pictures/videos to PC, you need to connect camera to your PC by USB cable. The larger plug of the USB cable fits into the computer, and the smaller plug fits into the slot on the side of the camera. Please note that the plugs fit only one way, do not force if they do not fit; try plugging in the other way.



Once camera is connected to PC, you can see a message (as shown) on screen’s lower-right corner.

Devices with Removable Storage



Removable Disk (G:)

Then enter “My Computer”, find the “Removable Disk” and enter it. You can see a file called “DCIM”. Enter the “DCIM” file and find another file called “100JLCAM”. Enter the “100JLCAM” file, you can see all the picture and video files. Now you can save them to your computer. Alternatively, you can take the SD card in the camera and transfer the captured pictures and videos into you computer and other memory media.

Producer: Easypix

Em Parkveedel 11 • 50733 Köln • Germany

easypix[®]

Keep it real.