



## User Manual

---

Thank you for buying the GoXtreme WiFi action camera. Before start using this product, please read this manual carefully to maximize its performance and extend the life of the product.

## Appearance and Buttons

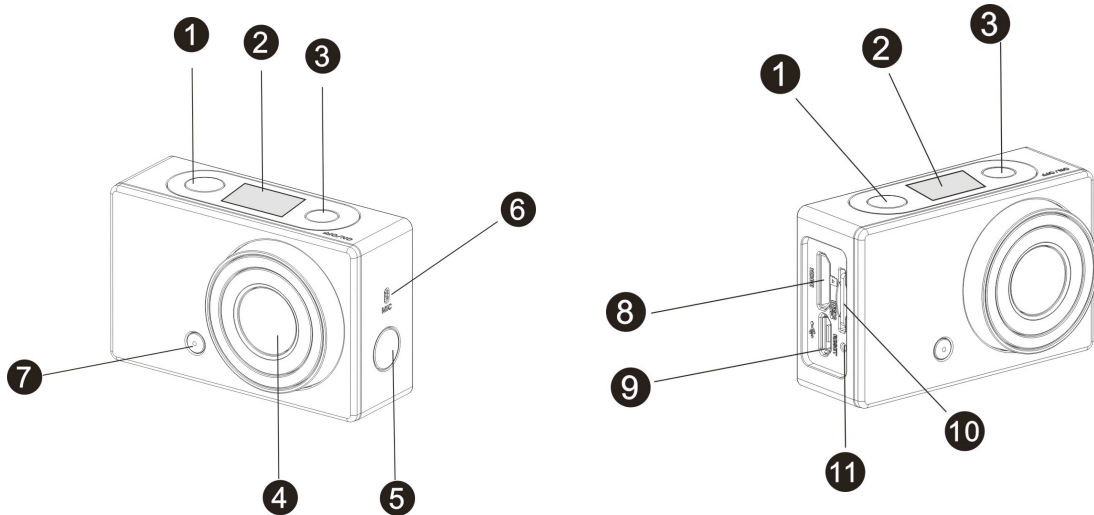

1. Shutter button
2. LCD display
3. Power / Mode button
4. Lens
5. Wi-Fi switch and status indicator (red)
6. Microphone

7. LED light
8. Micro HDMI port
9. Micro USB port
10. Micro SD card slot
11. Reset button

---

## LCD Display Illustration

Turn on the GoXtreme WiFi, the LCD will display the following status and settings:

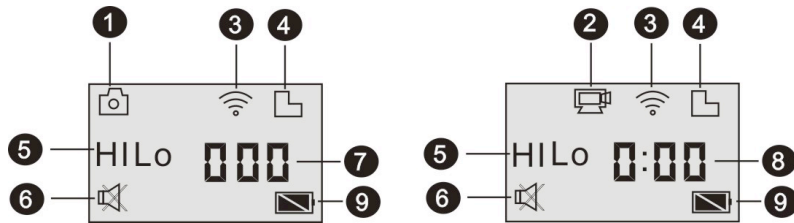

1. Camera mode
2. Video recording mode (default)
3. Wi-Fi icon (display when enabled)
4. TF card icon (display when loaded)
5. Resolution icon:

In camera mode, **HI** stands for 8 Mega Pixels (3264x2448), and in video recording mode, it stands for FHD (1920x1080,30fps);

In camera mode, **LO** stands for 5 Mega Pixels (2592x1944), and in video recording mode, it stands for 720P (1280x720,30fps);

**HILO** only displays in video recording mode, standing for 720P (1280x720,60fps).

6. Mute mode, displays when enabled, and disabled by default.

7. Counter, displays up to 999.

- 8. Timer, displays hours and minutes.
- 9. Battery icon: current battery level of the camera.

**Note:** the above icons may vary according to the status of the GoXtreme WiFi.

### **Working Mode Flow Chart**

After turn on the GoXtreme WiFi, you can press the Power/Mode button to switch the following modes in turn:

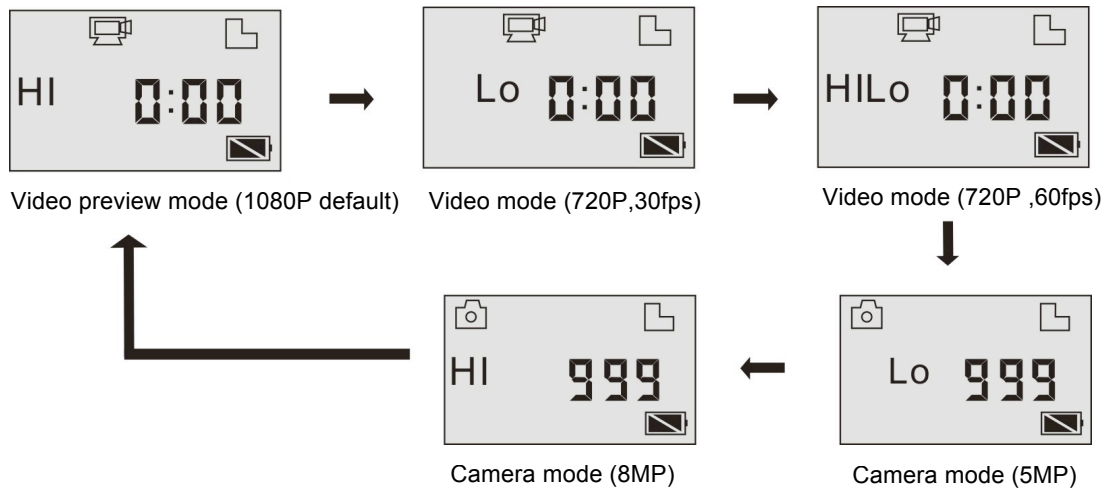

In video mode, press the Shutter button to start recording, LED flash, and press it again to stop;

In camera mode, press the Shutter button to take photo.

### **Use your GoXtreme WiFi**

**When you use the GoXtreme WiFi for the first time, please:**

1. Insert a micro SD or micro SDHC card, as shown in the following picture.

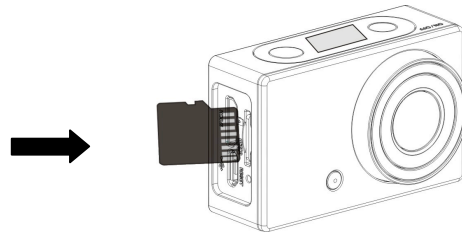

High speed card at least Class 4 is recommended; **Turn off the DV before inserting or removing the card.**

2. Charging the battery. The DV uses built-in rechargeable lithium battery. When the DV is off, connect it to the PC via USB cable to charge the battery. **During charging, the status indicator (blue) will light on, and the indicator off when charging completes.**

**Note: When the DV is on, connecting it to the PC will not charge.**

### **Turn on/off**

1. Turn on: press and hold the  button for about 3 seconds, LCD displays "ON" and a beep can be heard from buzzer.

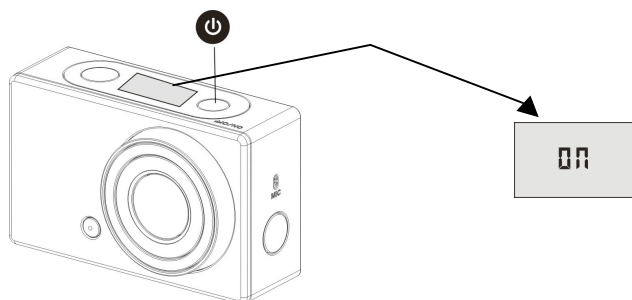

2. Turn off: press and hold the  button for about 3 seconds, LCD displays “OFF” and a beep can be heard from buzzer.

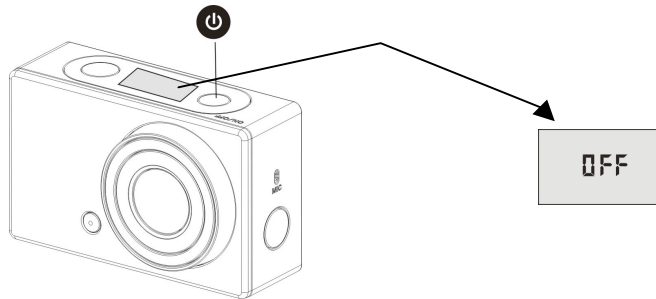





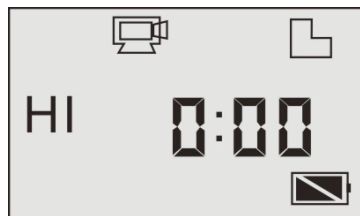

**Note: The DV will turn off automatically if it is idle for 5 minutes.**

### Start to Use





**Default setting:** After turn on the GoXtreme WiFi, the default setting is as below:





	Video recording mode icon	The DV is in video recording mode.
HI	Video resolution	FHD: 1080p@30fps
	Recording time	Stands for 0 hour and 00 minute.
	TF card icon	Display when a TF card is inserted, otherwise no display.
	Battery level	Battery is full
	Mute icon	The DV is in Mute mode, no Beep will be heard when pressing the buttons. It displays only when Mute mode is activated.



	Wi-Fi icon	Display when activated.
---	------------	-------------------------



The GoXtreme WiFi provides different shooting modes. Press the  button repeatedly, the following mode will display in turn:

	Video	Hi stands for FHD (1920x1080,30 fps) video
		Lo stands for 720P (1280x720,30 fps) video
		HILO stands for 720P (1280x720,60 fps) video
	Photo	Hi stands for 8M (3264 x 2448) resolution
		Lo stands for 5M (2592 x 1944) resolution
	Continuous shot	The DV supports taking 3 photos continuously (only via App)
	Self-timer	In self-timer mode , you can set 0s, 2s or 10s (only via App)

## 1. Video

To record a video, please check whether the DV is under Video mode. If the icon  is not displayed on the screen, press the  button repeatedly until it appears.

**Start recording:** Press and release the  button, the icon  and [:] displayed in LCD will flash. At the same time the red indicator will flash too, meaning the recording is in process.

**Stop recording:** Press and release the  button, the icon  and [:] displayed in LCD will stop flashing. At the same time the red indicator will stop flashing either, meaning the recording is stopped.



When the TF card is full, or the battery runs out, the recording will

---

stop automatically, and the recorded video will be saved before the DV turns off.

After reaching a max. video recording time of 29 minutes the camera will automatically stop. It can only be restarted manually.

## 2. Photo

To take a photo, please check whether the DV is under Camera mode. If the icon  is not displayed on the screen, press the  button repeatedly until it appears.

Press and release the  button, a beep will be heard and the red indicator will flash, meaning a photo is taken. (If you take photos more than 999 copies, the LCD screen display only 999)

## 3. Enable/disable Wi-Fi

The Wi-Fi is disabled by default. Press the Wi-Fi button on the side of the DV to enable it. When starting connecting to Wi-Fi network, the indicator will flash, and when a Wi-Fi network is connected, the indicator will remain on, and the Wi-Fi icon will display on LCD screen. (In order to save power, Wi-Fi will be automatically disabled if no terminal is connected after 30 seconds)



Wi-Fi is disabled by default



When Wi-Fi is enabled, the Wi-Fi icon will display on LCD



---

## 4. Enable/disable Mute mode

The buzzer is enabled by default. Under the Video or Photo mode, press and hold the Shutter button to disable the buzzer and indicator to enter Mute mode. Under Mute mode, the icon  will display on the screen; press and hold the Shutter button again to exit Mute mode.

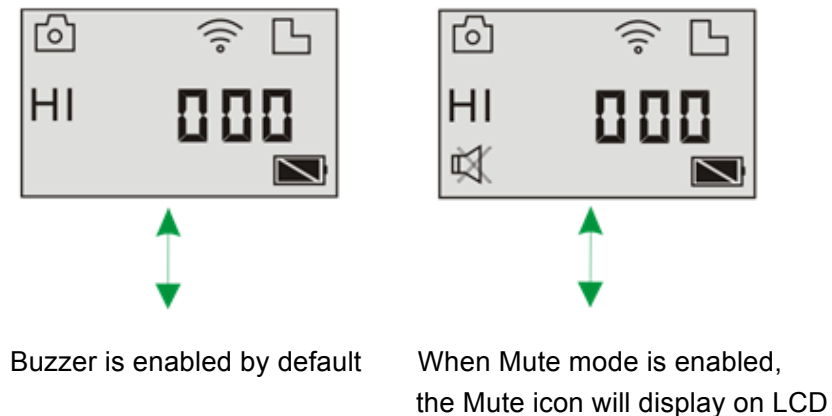

## 5. Connecting to HDTV

### 5.1 Connect the DV to HDTV via HDMI cable (optional)

If you need to transfer the image and audio to an HDTV for playback, insert the Com end of the HDMI cable to the DV, and the other end (output) to the HD input of the HDTV, as shown in the following figure:

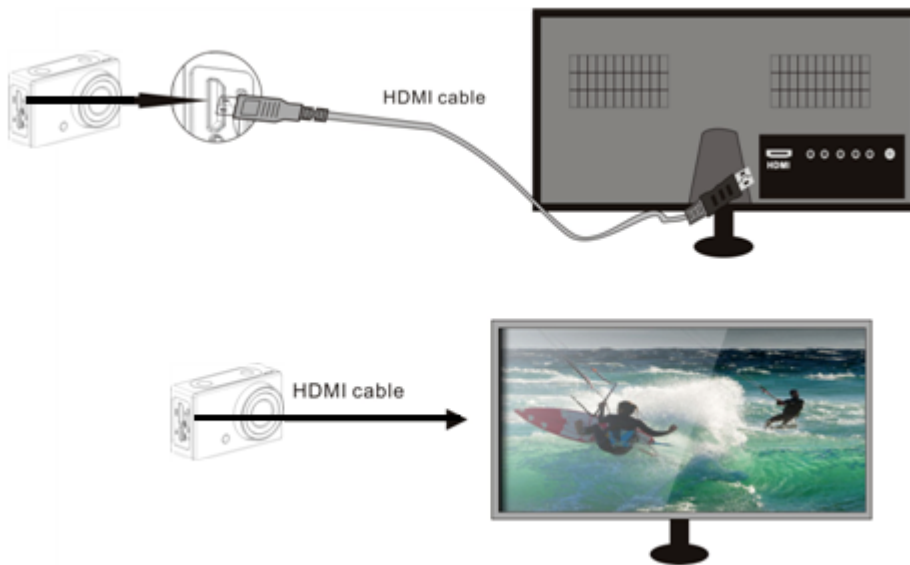



**Note: Before connecting or removing the HDMI cable, please stop video recording, playback and disconnect Wi-Fi first.**

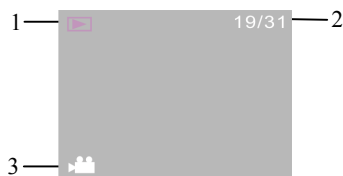



5.2 When HDTV is connected, it enters Playback mode, the LCD displays as below:



S/N	Icon name	Description
1	Playback mode	Under Playback mode currently.
2	File number	There are 31 files and you are viewing the 19 <sup>th</sup> one.
3	Video icon	The file is a video.

In Playback mode, press the Power button  to switch between photos and videos. When there are several photos or videos, press the Wi-Fi button  to select the photo or video. When a video file is selected, press the Shutter button  to play it, and press the Shutter button again to stop playing.

---

In Playback mode, press and hold the Shutter button , a prompt of deleting the file or formatting will appear. Press the Wi-Fi button  to switch between deleting or formatting, then press the Power button  to select Yes or No, and press the Shutter button  to confirm and exit.

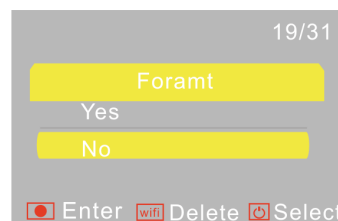
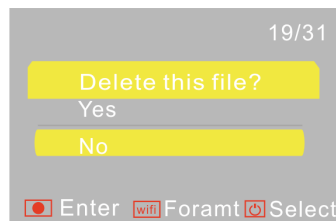

## 6. Connecting to PC

6.1 Turn on the DV and connect it to the USB port of the PC via the attached USB cable. The DV will enter U-disk mode and the LCD will display as below after connection:



Now you can view the photos or videos taken by DV on PC.

**Note: After the DV connecting to PC to enter U-disk mode, you will see two removable disks displayed in My computer of Windows, one is the TF card, storing all the photos taken and video recorded by users; the other one stores the system file information, including a file named SSID\_PW.CFG, containing the AP ID of the DV and the password for AP login. Users can view this information but cannot modify, delete or format them.**

---

6.2 In U-disk mode (PCU mode), press the Shutter button  to switch to web cam mode (PCC mode), and the LCD will display as below:



Now you can start the web cam through application. To return to U-disk mode (PCU mode), press the  button again.

**Note: Driver is not required for web cam mode (PCC mode) on Windows XP (SP3) version or above.**

## **APP (support Android and iOS)**

### **1. How to install an APP**

1.1 Search for "SYMAGIX" in Google Play (for Android OS), or scan



the QR code printed on the gift box to find the APP and install it according to the instruction.

1.2 Search for "SYMAGIX" in APP Store (for iOS) or scan the QR



code printed on the gift box to find the APP and install it according to the instruction.

---

## 2. Android APP

2.1 Install SYMAGIX APP (provided by dealer or via internet) on Android phone or tablet. When installation completes, the LCD will

display icon 

2.2 Insert the TF card and turn on the DV, then press the Wi-Fi button to enable it. Now you can see the Wi-Fi icon on the LCD.

2.3 Enable Wi-Fi on Android phone or tablet and search for wireless AP signal “GoXtreme WiFi”, then connect it to DV, until the system displays “Connected successfully”.

2.4 Click the icon  in the App list of the Android phone or tablet to open it. Now you can preview the image sent by the DV on the phone or tablet and start some operating. The operation interface on terminal is shown in the following figure.

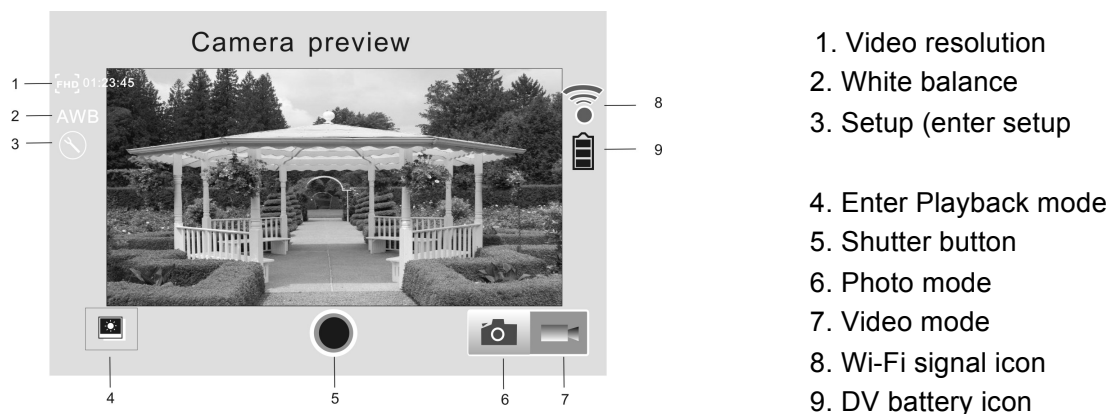

---

### 3. iOS APP

3.1 Install SYMAGIX APP (provided by dealer or via internet) on iOS phone or tablet. When installation completes, the LCD will

display icon  SYMAGIX.

3.2 Insert the TF card and turn on the DV, then press the Wi-Fi button to enable it. Now you can see the Wi-Fi icon on the LCD.

3.3 Enable Wi-Fi on iOS phone or tablet and search for wireless AP signal “GoXtreme WiFi”, then connect it to DV, until the system displays “Connected successfully”.

Note: While connecting to DV for the first time, you need to enter password “1234567890”. And will not require typing the code again once connected previously.

3.4 Click the icon  in the App list of the iOS phone or tablet to open it. Now you can preview the image sent by the DV on the phone or tablet and start operating. The operation interface on terminal is shown in the following figure.

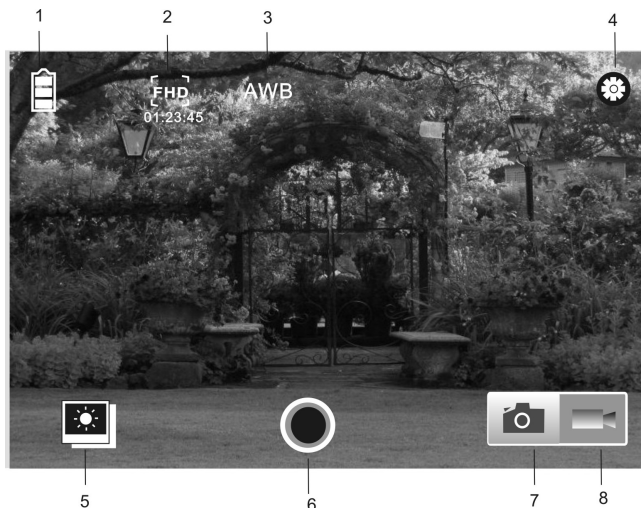

1. DV battery icon
2. Video resolution
3. White balance
4. Setup (enter setup menu)
5. Enter Playback mode
6. Shutter button
7. Photo mode
8. Video mode

---

**Note:**

- 1. A TF card must be inserted if you need to take a photo, record a video or download files on the terminal.**
- 2. The Wi-Fi indicator will remain on when the terminal is connected to DV.**

**DECLARATION OF CONFORMITY**

easypix hereby declares that the product GoXtreme WiFi is in conformity to all the essential requirements of Directive 1999/5/EC. The declaration of conformity can be downloaded here: [http://www.easypix.info/download/pdf/doc\\_goxtreme\\_wifi.pdf](http://www.easypix.info/download/pdf/doc_goxtreme_wifi.pdf)

For technical help please visit our support area on [www.easypix.eu](http://www.easypix.eu).



Only EU