

easypix®

GO X TREME®

WiFi PRO

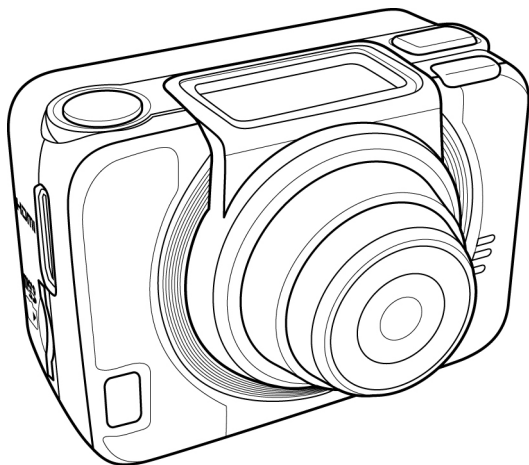

User's Manual

Table of Contents

<i>About this manual</i>	<i>iv</i>
<i>Copyright</i>	<i>iv</i>
<i>Precautions</i>	<i>v</i>
Operating conditions	<i>vi</i>
<i>Notes on Waterproof Case</i>	<i>vii</i>
<i>Before You Start</i>	<i>x</i>
1 Introducing the Camera	1
1.1 System Requirements	1
1.2 Features	1
1.3 Unpacking the Camera	2
1.4 About the Camera	4
1.4.1 Camera Views.....	4
1.4.2 Button Functions	5
1.4.3 LED Indicators.....	6
2 Getting Started	7
2.1 Installing the Micro SD Card	7
2.1.1 Removing the Micro SD card	8
2.2 Installing the Battery	8
2.2.1 Removing the battery	9
2.3 Charging the Battery	10
2.4 Turning ON/ OFF the Camera	11
2.5 OLED Screen	12
2.6 Changing Modes	15
2.7 Connecting to TV (HDMI Cable)	16

2.8	<i>Connecting to PC (Micro USB Cable)</i>	16
3	Capturing Videos and Photos	17
3.1	<i>Recording Videos</i>	17
3.2	<i>Taking Photos</i>	17
3.2.1	WiFi.....	18
3.2.2	Burst Shooting	18
3.2.3	Time Lapse Shooting	19
3.2.4	Self-Timer	19
4	Adjusting the Settings	20
4.1	<i>Video Resolution</i>	22
4.2	<i>Photo</i>	25
4.3	<i>Timer</i>	27
4.4	<i>Shooting Interval</i>	28
4.5	<i>Up/Down</i>	30
4.6	<i>Delete</i>	31
4.7	<i>OSD Up/Down</i>	33
4.8	<i>LED</i>	34
4.9	<i>Brightness</i>	35
4.10	<i>Beep</i>	36
4.11	<i>Auto-Off</i>	37
4.12	<i>Date and Time</i>	38
4.13	<i>RF</i>	40
4.14	<i>Factory Default</i>	42
5	Using the Accessories	43

5.1	<i>Waterproof Case</i>	43
5.1.1	Using the Waterproof Case	43
5.1.2	Changing the T Tip Adapter	45
5.1.3	Changing the Housing Back Door.....	46
5.2	<i>Velcro Strap</i>	46
5.3	<i>Assembling the Camera Accessories</i>	47
5.4	<i>RF Watch Remote Control</i>	48
Appendix	50
	<i>Specifications</i>	50
	<i>Troubleshooting</i>	52
	<i>FCC Statement</i>	53
	<i>Radiation Exposure Statement</i>	53

Preface

Congratulations on your purchase of this advanced camera. Ensure that you read this manual carefully and keep it in a safe place for future reference.

About this manual

Every effort has been made to ensure that the contents of this manual are correct and up to date. However, no guarantee is made regarding the accuracy of the contents. The manufacturer reserves the right to change the contents, technology, and specifications without notice.

Copyright

© Copyright 2013.

All rights reserved. No part of this publication may be reproduced, transmitted, transcribed, stored in a retrieval system or translated into any language or computer language, in any form or by any means, electronic, mechanical, magnetic, optical, manual or otherwise, without the prior written permission of the manufacturer.

Precautions

General precautions

- Do not store the product in dusty, dirty, or sandy areas, as its components may be damaged.
- Do not store the product in a hot environment. High temperatures can shorten the life of electronic devices, damage batteries and warp or melt certain plastics.
- Do not store the product in cold areas. When the product warms up to its normal temperature, moisture can form inside, which may damage the electronic circuits.
- Do not attempt to open the casing or attempt your own repairs. High-voltage internal components create the risk of electric shock when exposed.
- Do not drop or knock the product. Rough handling may damage the internal components.
- Do not use harsh chemicals, cleaning solvents or strong detergents to clean the product. Wipe the product with a slightly damp soft cloth.
- Do not open the battery cover while an image is being recorded. Doing so will not only make storage of the current image impossible, it can also corrupt other image data already stored on file.
- If the product or any of its accessories are not working properly, take them to your nearest qualified service center. The personnel there will assist you and if necessary, arrange for the product to be repaired.
- Test for proper operation before using the camera.

Operating conditions

- This camera is designed for use in temperatures ranging from 0°C to 40°C (32°F to 104°F).
- Do not use or keep the camera in the following areas:
 - In areas subject to direct sunlight
 - In areas subject to high humidity or dust
 - Near air conditioners, heaters, or other areas subject to temperature extremes
 - Inside of a closed vehicle, especially one parked in the sun.
 - In areas subject to strong vibration

Power supply

- Use only the type of battery that came with your camera. Using any other type of battery may damage the equipment and invalidate the warranty.
- Do not short the battery terminals. The battery could overheat.
- Do not attempt to split or peel the outer casing.
- Remove the battery if the camera is not going to be used for a long time. If the battery is left unused for more than 3 months, you need to charge the battery before use.

Notes on Waterproof Case

Waterproof Case performance

- The waterproof case performance is equivalent to IPX8 (60m/1hr).
- Underwater time limit: Do not use the waterproof case underwater for more than 60 minutes and 60 meters to ensure water resistance.
- The waterproof case is not dust-proof.
- The camera and other accessories are not waterproof unless enclosed by the waterproof case.
- When using the camera in cold or humid environments or when going underwater, use the anti-fog insert to prevent fogging. The anti-fog insert only provides a certain degree of prevention, results vary depending on the actual environment. The anti-fog insert is not for long-term use, it must be replaced regularly.

Notes before going underwater:

(Do the following actions indoors. Do not do these actions on sandy or dusty environment or near the water's edge.)

- Check if the area surrounding the waterproof case lock is clean, do not allow dirt or sand or foreign objects around it.
- Ensure that the waterproof case is closed.
- Ensure that the waterproof case has no cracks or scratches. If the waterproof case has been dropped, contact your dealer for a replacement.

Notes for general use:

- Avoid opening or closing the waterproof case near the water's edge (sea, lake, beach, lake, etc.). Do not open or close the waterproof case lock with wet hands, or hands with sand or dust.
- The accessories (batteries, etc.) used with the camera are not water resistant, be careful in using them.
- Do not drop the waterproof case to ensure waterproof durability.
- Do not place the waterproof case in temperatures above 40°C or below 0°C to ensure waterproof durability.
- Do not attempt to make alterations on the waterproof case or seal the vents yourself, doing so may damage its ability to maintain the camera waterproof.

When using the camera

- The waterproof properties of the waterproof case apply to fresh water and saltwater only; they do not apply to cleaning substances, chemicals, or water from spas, etc. Any such liquids should be wiped off immediately.
- Do not immerse the waterproof case in water at a depth greater than 60 meters.
- Do not subject the waterproof case to highly pressurized water.
- Do not immerse in water for longer than 60 minutes. After 60 minutes of use in water, allow the waterproof case to dry for at least 10 minutes.
- Do not immerse in water warmer than 40°C (104°F).
- Do not open or close the waterproof case lock with wet hands.
- Do not open the waterproof case lock next to water or a pool.
- The waterproof case is not dust-proof.

- Do not bump or knock the waterproof case underwater, otherwise the lock may open.

Notes on waterproof case maintenance

- The waterproof of sealing material is replaceable for a fee. The material should be replaced once a year to maintain its water resistance.

After using the waterproof case

- Be sure to come ashore within 60 minutes after going underwater, this will maintain the appearance, quality and water resistance of the waterproof case.
- After taking pictures underwater, clean the waterproof case with running tap water. Do not use any soapy water, mild detergents, alcohol or similar liquids to clean the case.
- Wipe off water drops on the waterproof case with a soft lint-free cloth (avoid fiber). Be sure to wait until the waterproof case is completely dry before opening the waterproof case lock.
- After removing the camera from the waterproof case, soak the waterproof case in a bucket of clean water for about 10 minutes. After 10 minutes, wipe the waterproof case dry with a lint-free cloth. Place the waterproof case in a well ventilated cool place to dry naturally (do not place under direct sunlight).

Other notes

- If water accidentally enters the camera or any problem occurs when it is in water, please get it out of the water immediately and take proper actions. Dry the camera and send it for repair, if required.
- Information is subject to change without notice. Refer to the important notes in the manual supplied with the camera.

Before You Start

Take some test shots before you use your camera.

Before taking pictures with this camera, test the camera beforehand to ensure that it functions properly. Any additional loss caused by the malfunction of this product (such as costs of photography or any loss of benefit generated by the photography) is not the responsibility of the manufacturer and no compensation will be given for it.

Copyright information

Take care to observe "No Photography" notices in certain locations. In these cases, you cannot record any live performance, improvisation or exhibits, even for personal purposes. Any transfer of pictures or memory card data must be conducted under the constraints of copyright law.

1 Introducing the Camera

Read this section to learn about the features and functions of the camera. This chapter also covers system requirements, package contents, and descriptions of the hardware components.

1.1 System Requirements

The camera requires a PC with the following specifications for full HD 1080p 30fps and 720p 60fps playback:

- Windows® 8 /Windows® 7 /Vista / XP (SP2) / MAC OS X 10.5 and later
- Intel® / AMD Dual-Core CPU and later
- At least 1 GB of RAM or higher
- At least DirectX 9 video card, DirectX 10 is recommended
- Standard USB 1.1 port and later
- At least 2GB or greater available hard disk space

● **Note:**

A USB 1.1 port will enable you to transfer files to and from your host PC, but transfer speeds will be faster with a USB 2.0 port.

1.2 Features





The camera offers a variety of features and functions including:

- Full HD 1080p (60fps.)
- H.264 Video Clip
- 140° Wide Angle Lens
- WLAN 802.11 b/g/n
- 2.4GHz RF remote control
- 16 Megapixel Photos
- Sports Camera functionality

- Li-ion Rechargeable Battery
- External Waterproof Case/Standard Mounts/Watch Remote
- Smartphone App Supported

1.3 Unpacking the Camera

The following items should be present in the package. If any item is missing or appears damaged, contact your dealer immediately.

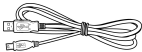
 <p>Camera</p>	 <p>Li-ion Battery</p>	 <p>User Manual</p>
 <p>CD-ROM</p>	 <p>Micro USB Cable</p>	

Standard Accessories



Waterproof Case



Vented Housing Backdoor

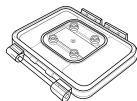

Waterproof Housing Backdoor



T Tip Adapter



Flat Adhesive Socket



Curved Adhesive Socket



Secure Tether

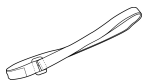

Velcro Strap

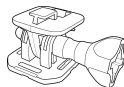

Swivel T Tip



Anti-fog Inserts



Safety Lock

Adapter
for optional
GoXtreme®
Accessories

1.4 About the Camera

Refer to the following illustrations to familiarize yourself with the buttons and controls of this camera.

1.4.1 Camera Views

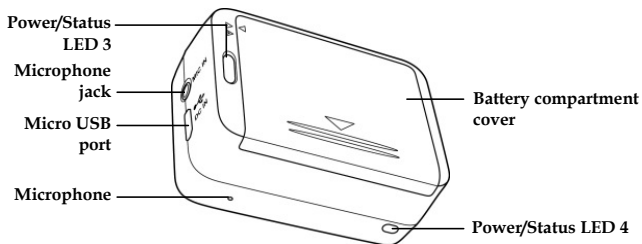
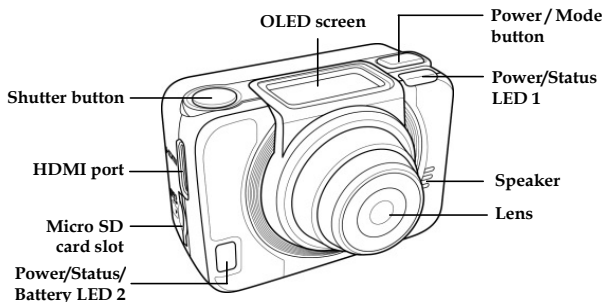

1.4.2 Button Functions

Power / Mode Button	<ul style="list-style-type: none">• Press and hold for 3 seconds to turn the camera on or off.• Press to switch to different modes: Video, Photo, WiFi, Burst, Time Lapse, Self-timer, and Set mode.• In Set mode, press to scroll through menu items.
Shutter Button	<ul style="list-style-type: none">• In Video mode, press to start/stop video recording.• In Photo mode, press to take a photo.• In Set mode, press to select an item.

1.4.3 LED Indicators

The camera has four LED indicators.

The Power/Status LEDs are located on top, on the bottom, and on the back of the camera. These LEDs are designed for users to see the status of the camera whichever way the camera is held or mounted.

LED	Color	Description
Power / Status LED	Green	During startup
	Green Blinking	Taking photos/ WiFi initial setup is complete and connection is in progress
	Red Blinking	Video recording in progress
	Red Blinking Rapidly	Self-timer
Battery LED	Red Blinking	Battery is charging
	Off	Full charge

2 Getting Started

Read this section to learn how to start using the camera. This section covers basic functions such as switching on, installing the battery and micro SD card, and configuring preliminary settings. See later chapters for advanced functions.

2.1 Installing the Micro SD Card

A micro SD card is required to capture photos and videos. The camera supports micro SDHC cards up to 32GB.

1. Insert the micro SD card into the card slot with the gold contacts facing the front of the device.

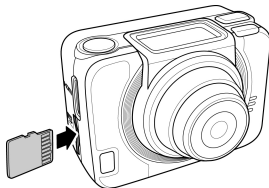

2. Push the micro SD card until it clicks into place.

- **Warning:** Do not remove the micro SD card while data is being recorded. Doing so may corrupt the saved data and damage the card.

2.1.1 Removing the Micro SD card

1. Turn off the camera.
2. With a fingertip, push the micro SD card to eject it from the slot.
3. Remove the micro SD card.

2.2 Installing the Battery

- **Warning:** Use only the supplied battery or a similar battery recommended by the manufacturer or the dealer.

1. Push down the battery compartment cover to open it.

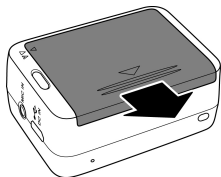

2. Align the battery contacts and then insert the battery into the compartment with the ribbon underneath the battery.

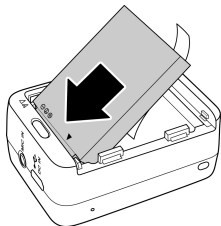

3. Close the battery compartment cover.

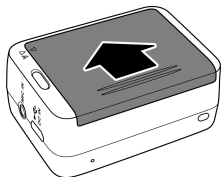

2.2.1 Removing the battery

1. Open the battery compartment cover.
2. Pull the ribbon to remove the battery.

2.3 Charging the Battery

You can charge the battery using the micro USB cable that came with the camera. Follow the steps below to charge the battery.

1. Install the battery into the battery compartment.
2. Plug the micro-USB connector to the USB port of your device.
3. Plug the other end of the USB cable to a computer.

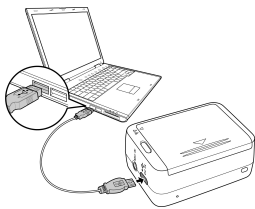

Note:

- The battery LED blinks red. After a full charge, the LED turns off.
- Approximate charging time is 240 minutes with a USB connection. Actual charging time depends on current battery capacity and charging conditions.
- You may also use a simple USB-AC adapter or smartphone charger to charge your camera battery.

2.4 Turning ON/ OFF the Camera

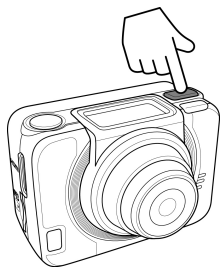

- To turn on the camera, press the **Power** button. The Power/Status LED indicator lights green for 3 seconds.
- To turn off the camera, press and hold the **Power** button for 3 seconds.





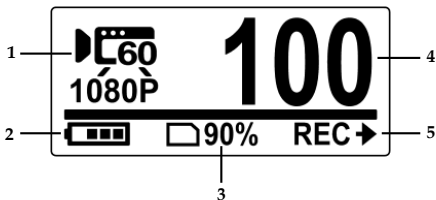





2.5 OLED Screen

When the camera is turned on, the OLED screen displays the following information:



	Current Mode	Displays the current mode of the camera.
1	 Video Mode	Use this mode to record videos. The icon also indicates the current video recording settings.
	 Photo Mode	Use this mode to capture photos. The icon also indicates the current capture settings.
	 WiFi Mode	Select to connect the camera to a smartphone using WiFi connection. With this feature, videos and photos recorded from the camera can be viewed on the smartphone.

1		Burst Mode	Use this mode to capture 10 continuous photos with one press of the Shutter button.
		Time Lapse Mode	In this mode, photos are continuously captured with a specific interval time when the Shutter button is pressed. To stop capturing, press the Shutter button again. The icon also indicates the current capture settings.
		Self-timer Mode	In this mode, photos are taken 10 or 2 seconds after pressing the Shutter button. The icon also indicates the current capture settings.
		Set Mode	Use this mode to adjust the settings of your camera.
2		Battery	Indicates the battery capacity.
3		Memory status	Indicates the memory storage status.
4	Number of Files		Indicates the total number of shots.
5	Button Function		Indicates the operation that the camera will do when the Shutter button is pressed. The displayed icon varies depending on the mode.
		Record	Press the Shutter button to record videos.
		Capture	Press the Shutter button to capture photos.
5		On	Press the Shutter button to activate

		Wi-Fi function.
OK ➔	Confirm	Press the Shutter button to enter the SETUP menu.

2.6 Changing Modes

Press the **Mode** button repeatedly to switch modes.

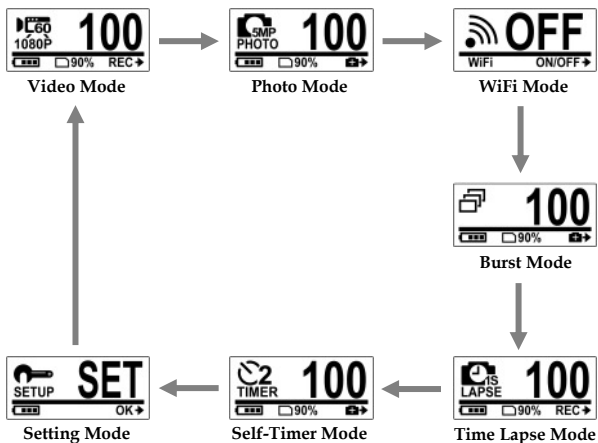

2.7 Connecting to TV (HDMI Cable)

You can also connect the camera to a TV using the HDMI cable (optional).

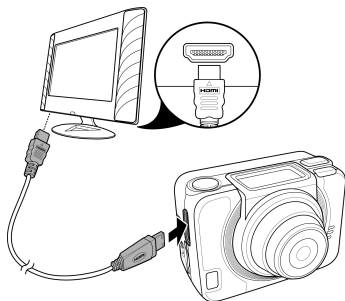

2.8 Connecting to PC (Micro USB Cable)

Connect the camera to a computer with the micro USB cable provided as shown.

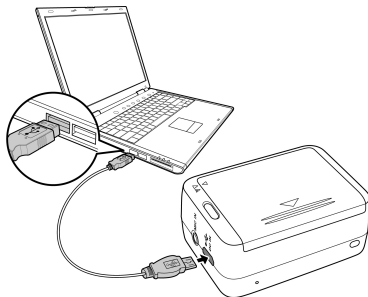

3 Capturing Videos and Photos

3.1 Recording Videos

Your camera supports Dual Stream recording. When a video is recorded, two video files of different file size are automatically saved in the memory card. The smaller file is used to view videos using a smartphone.

1. Turn on the camera. By default, the camera automatically opens to **Video** mode.
2. Press the **Shutter** button to start recording.
3. Press the **Shutter** button to stop recording.



After reaching a max. video recording time of 29 minutes the camera will automatically stop. It can only be restarted manually.

3.2 Taking Photos

1. Turn on the camera.
2. Press the **Mode** button to switch to **Photo** mode.
3. Press the **Shutter** button to capture a photo.

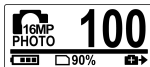

3.2.1 WiFi

This menu allows you to connect your camera to a smartphone using WiFi connection and view or record the videos and photos from your camera on the smartphone.

- **Note:** Before using this feature, download the **ActionCam!** app from AppStore (iOS) or Google Play (Android OS) on your smartphone.

1. Press the **Mode** button repeatedly to switch to **WiFi** mode.



2. Press the **Shutter** button to toggle WiFi ON or OFF.
3. Press the **Mode** button to exit the WiFi screen.
4. Wait for 30 seconds until the LED flashes to indicate Wi-Fi connection is established.
5. On your smartphone, enable Wi-Fi connection, then search and connect to the Wi-Fi network **ActionCam_xxxxxx**.
6. When prompted for a password, enter the default password "1234567890".
7. Use the **ActionCam!** app to view videos and photos from your camera.

3.2.2 Burst Shooting

This feature allows you to capture 7 photos with one press of the **Shutter** button.

1. Press the **Mode** button repeatedly to switch to **Burst** mode.
2. Press the **Shutter** button to start capturing photos.



3.2.3 Time Lapse Shooting

This feature allows you to continuously capture photos with one press of the Shutter button at the preset interval time (1/3/5/10/30/60 seconds). Shooting only stops when the Shutter button is pressed again.

You can use this feature to record videos such as evolution of a construction project, weather changes, or flower blossom.

For Video lapse function, those continuous shots are combined and saved into one video automatically. The recorded video is played back in fast motion (faster than the normal playback speed).

For Photo lapse function, it will continuously capture 16M photos and you need to use a third party software to create a video clip.

1. Press the **Mode** button repeatedly to switch to **Time Lapse** mode.



2. Press the **Shutter** button to start capturing photos.

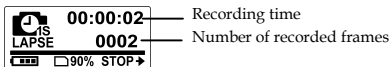

3. Press the **Shutter** button again to stop capturing photos.

3.2.4 Self-Timer

This feature allows you to capture a photo after a short delay.

1. Press the **Mode** button repeatedly to switch to **Self-timer** mode.









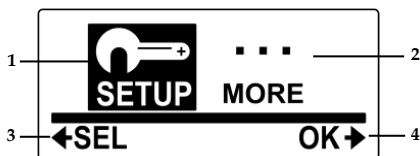







2. Press the **Shutter** button. The photo is captured after 10 or 2 seconds.

4 Adjusting the Settings

To adjust the camera settings, press the **Mode** button repeatedly to switch to **Set** mode and then press the **Shutter** button to confirm. The screen below is displayed:



	SETUP Menu	Select SETUP to adjust capture settings.
	 Video	Select to adjust the video resolution.
	 Photo	Select to adjust the image resolution.
	 Timer	Select to specify the self-timer delay.
1	 Time Lapse	Select to adjust the interval time between capturing photos in Time Lapse mode.
	 Up/Down	Select to set the camera direction upside down. This feature is useful when using the camera as a vehicle recorder.
	 Loop	Select to enable/disable the loop recording function.

1	 Delete	Select to delete captured videos or photos from the micro SD card.
	 Exit	Select to close the SETUP menu and return to the previous menu screen.
2	MORE Menu	Select MORE to adjust basic camera settings.
	 Up/Down	Select to set the direction of the OSD screen display.
	LED LED	Select to turn the LED on or off.
	 Bright	Select to adjust the screen brightness.
	 Beep	Select to adjust the beep volume.
	 Auto-Off	Select to set the time for the camera to automatically turn off when not in use.
	 Time	Select to set the camera date and time.
	RF RF	Select to pair with the RF remote control.
	 Default	Select to set the camera to default factory settings.
	 Exit	Select to close the MORE menu and return to the previous menu screen.
3	←SEL Select	Press the Mode button to scroll and highlight menu items.
4	OK→ Confirm	Press the Shutter button to confirm a highlighted item.

4.1 Video Resolution

Your camera supports Dual Stream recording. When a video is recorded, two video files of different file size are automatically saved in the memory card. The smaller file is used to view videos using a smartphone. The camera supports nine resolution options for videos. Set the video resolution before you start recording a video.





Do the following to select the video resolution.

1. Press the **Mode** button repeatedly to change to **SET** mode.
2. Press the **Shutter** button to enter **SET** mode.
3. Press the **Shutter** button to enter the **SETUP** menu.
4. Press the **Shutter** button to enter the **VIDEO** submenu.

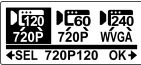

5. Press the **Mode** button repeatedly to scroll through the resolution options.

	16:9, 1080P (1920x1080, 60fps)
	16:9 Ultra Wide, 1080P (1920x1080, 30fps)
	16:9 Wide, 1080P (1920x1080, 30fps)

 <p>1080P 960P 960P ←SEL 1080P30 OK→</p>	16:9 Narrow, 1080P (1920x1080, 30fps)
 <p>1080P 960P 960P ←SEL 960P60 OK→</p>	4:3, 960P (1280x960, 60fps)
 <p>1080P 960P 960P ←SEL 960P30 OK→</p>	4:3, 960P (1280x960, 30fps)
 <p>720P 720P WVGA ←SEL 720P120 OK→</p>	16:9, 720P (1280x720, 120fps)
 <p>720P 720P WVGA ←SEL 720P60 OK→</p>	16:9, 720P (1280x720, 60fps)
 <p>720P 720P WVGA ←SEL WVGA240 OK→</p>	16:9, WVGA (848x480, 240fps)

6. Press the **Shutter** button to confirm.
7. To exit the menu, press the **Mode** button repeatedly until the EXIT screen appears.
8. Press the **Shutter** button to exit SET mode.



Note: The FOV of every resolution is different.

Resolution	Resolution	Field of view
1080p60	1920*1080 (16:9)	126
1080p30 U	1920*1080 (16:9)	126
1080p30 W	1920*1080 (16:9)	102
1080p30 N	1920*1080 (16:9)	75
720p60	1280*720 (16:9)	126
720p120	1280*720 (16:9)	102
960p	1280*960(4:3)	140
WVGA	848*480 (16:9)	140

4.2 Photo

This menu allows you to set the resolution before you capture an image.

Do the following to select the image resolution.

1. Press the **Mode** button repeatedly to change to **SET** mode.
2. Press the **Shutter** button to enter **SET** mode.
3. Press the **Shutter** button to enter the **SETUP** menu.
4. Press the **Mode** button to highlight **PHOTO**.
5. Press the **Shutter** button to enter the **PHOTO** submenu.



6. Press the **Mode** button repeatedly to scroll through the image resolution options: **16MP**, **12MP**, **8MP**, and **5MP**.

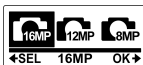

7. Press the **Shutter** button to confirm.
8. To exit the menu, press the **Mode** button repeatedly until the **EXIT** screen appears.
9. Press the **Shutter** button to exit **SET** mode.



Note: The FOV of every resolution is different.

Resolution	4:3 Resolution	Field of view
Still image 16M	4632 x 3488, 16M	142
Still image 12M	4000 x 3000, 12M	118
Still image 8M	3264 x 2446, 8M	93
Still image 5M	2592 x 1944, 5M	73

4.3 Timer

This menu allows you to set the self-timer delay.

Do the following to select the desired self-timer setting.

1. Press the **Mode** button repeatedly to change to **SET** mode.
2. Press the **Shutter** button to enter **SET** mode.
3. Press the **Shutter** button to enter the **SETUP** menu.
4. Press the **Mode** button to highlight **TIMER**.
5. Press the **Shutter** button to enter the **TIMER** submenu.



6. Press the **Mode** button repeatedly to scroll through the self-timer options: **2S** and **10S**.



7. Press the **Shutter** button to confirm.
8. To exit the menu, press the **Mode** button repeatedly until the **EXIT** screen appears.
9. Press the **Shutter** button to exit **SET** mode.



4.4 Shooting Interval

This menu allows you to select the interval options when capturing photos using Lapse mode.

Do the following to select the shooting interval.

1. Press the **Mode** button repeatedly to change to **SET** mode.
2. Press the **Shutter** button to enter **SET** mode.
3. Press the **Shutter** button to enter the **SETUP** menu.
4. Press the **Mode** button to highlight **LAPSE**.
5. Press the **Shutter** button to enter the **LAPSE** submenu.



6. Press the **Mode** button repeatedly to select **LAPSE MODE** or **LAPSE TIME**.



7. Do the following:
 - To select the recording mode, highlight **LAPSE MODE** and press the **Shutter** button. Then press the **Mode** button repeatedly to select **VIDEO** or **PHOTO**.



- To set the shooting interval, highlight **LAPSE TIME** and press the **Shutter** button. Then press the **Mode** button repeatedly to scroll through the shooting interval options: **1 SEC**, **3 SEC**, **5 SEC**, **10 SEC**, **30 SEC**, and **60 SEC**.



8. Press the **Shutter** button to confirm.

9. To exit the menu, press the **Mode** button repeatedly until the **EXIT** screen appears.



10. Press the **Shutter** button to exit **SET** mode.

4.5 Up/Down

This menu allows you to capture videos and photos upside down. You can enable this feature when you mount the camera upside down so that the captured shots appear right side up when you review it on your computer or TV.

Do the following to enable this feature.

1. Press the **Mode** button repeatedly to change to **SET** mode.
2. Press the **Shutter** button to enter **SET** mode.
3. Press the **Shutter** button to enter the **SETUP** menu.
4. Press the **Mode** button to highlight **UP/DOWN**.
5. Press the **Shutter** button to enter the **UP/DOWN** submenu.



6. Press the **Mode** button to select **ON**.



7. Press the **Shutter** button to confirm.
8. To exit the menu, press the **Mode** button repeatedly until the **EXIT** screen appears.



9. Press the **Shutter** button to exit **SET** mode.

Note: WVGA does not support up/down function.

4.6 Delete



This menu allows you to delete all files in the Micro SD card.

Do the following to delete all files.

1. Press the **Mode** button repeatedly to change to **SET** mode.
2. Press the **Shutter** button to enter **SET** mode.
3. Press the **Shutter** button to enter the **SETUP** menu.
4. Press the **Mode** button to highlight **DELETE**.
5. Press the **Shutter** button to enter the **DELETE** submenu.



6. Press the **Mode** button repeatedly to scroll through the delete options.

	To delete the last captured video or photo.
	To delete all files in the micro SD card.
	To format the micro SD card.

7. Press the **Shutter** button to confirm.

8. Press the **Mode** button to select ✓ to confirm deletion.



9. Press the **Shutter** button to confirm.

10. To exit the menu, press the **Mode** button repeatedly until the **EXIT** screen appears.



11. Press the **Shutter** button to exit **SET** mode.

4.7 OSD Up/Down

This menu allows you to display the OLED screen upside down. Do the following to enable this feature.

1. Press the **Mode** button repeatedly to change to **SET** mode.
2. Press the **Shutter** button to enter **SET** mode.
3. Press the **Mode** button to highlight **MORE**.
4. Press the **Shutter** button to enter the **MORE** menu.
5. Press the **Shutter** button to enter the **UP/DOWN** submenu.



6. Press the **Mode** button to select **OSD UP** or **OSD DOWN**.



7. Press the **Shutter** button to confirm.
8. To exit the menu, press the **Mode** button repeatedly until the **EXIT** screen appears.
9. Press the **Shutter** button to exit **SET** mode.



4.8 LED

This menu allows you to turn the LED on or off.

Do the following to turn the LED on or off.

1. Press the **Mode** button repeatedly to change to **SET** mode.
2. Press the **Shutter** button to enter **SET** mode.
3. Press the **Mode** button to highlight **MORE**.
4. Press the **Shutter** button to enter the **MORE** menu.
5. Press the **Mode** button to highlight **LED**.
6. Press the **Shutter** button to enter the **LED** submenu.



7. Press the **Mode** button to select **ON** or **OFF**.



8. Press the **Shutter** button to confirm.
9. To exit the menu, press the **Mode** button repeatedly until the **EXIT** screen appears.



10. Press the **Shutter** button to exit **SET** mode.

4.9 Brightness

This menu allows you to adjust the OLED screen brightness.

Do the following to adjust the screen brightness.

1. Press the **Mode** button repeatedly to change to **SET** mode.
2. Press the **Shutter** button to enter **SET** mode.
3. Press the **Mode** button to highlight **MORE**.
4. Press the **Shutter** button to enter the **MORE** menu.
5. Press the **Mode** button to highlight **BRIGHT**.
6. Press the **Shutter** button to enter the **BRIGHT** submenu.



7. Press the **Mode** button repeatedly to select **100%**, **60%**, or **30%**.

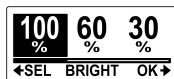

8. Press the **Shutter** button to confirm.
9. To exit the menu, press the **Mode** button repeatedly until the **EXIT** screen appears.
10. Press the **Shutter** button to exit **SET** mode.



4.10 Beep

This menu allows you to enable or disable the beep sound when you press the **Power / Mode** or **Shutter** buttons.

Do the following to enable or disable the beep sound.

1. Press the **Mode** button repeatedly to change to **SET** mode.
2. Press the **Shutter** button to enter **SET** mode.
3. Press the **Mode** button to highlight **MORE**.
4. Press the **Shutter** button to enter the **MORE** menu.
5. Press the **Mode** button to highlight **BEEP**.
6. Press the **Shutter** button to enter the **BEEP** submenu.



7. Press the **Mode** button repeatedly to scroll through the beep options.

<p>100% 60% OFF ←SEL BEEP OK→</p>	To set the beep volume to its loudest.
<p>100% 60% OFF ←SEL BEEP OK→</p>	To set the beep volume to middle range.
<p>100% 60% OFF ←SEL BEEP OK→</p>	To turn off beep.

8. Press the **Shutter** button to confirm.
9. To exit the menu, press the **Mode** button repeatedly until the **EXIT** screen appears.
10. Press the **Shutter** button to exit **SET** mode.



4.11 Auto-Off

This menu allows you to program the camera to automatically turn off after being idle for a specific period of time, or you can set the setting to OFF to keep the camera on until you manually turn it off.

Do the following to select the auto-off option.

1. Press the **Mode** button repeatedly to change to **SET** mode.
2. Press the **Shutter** button to enter **SET** mode.
3. Press the **Mode** button to highlight **MORE**.
4. Press the **Shutter** button to enter the **MORE** menu.
5. Press the **Mode** button to highlight **AUTO-OFF**.
6. Press the **Shutter** button to enter the **AUTO-OFF** submenu.



7. Press the **Mode** button repeatedly to select **1 MIN**, **3 MIN**, **5 MIN**, **10 MIN**, **30 MIN**, **60 MIN**, or **OFF**.



8. Press the **Shutter** button to confirm.
9. To exit the menu, press the **Mode** button repeatedly until the **EXIT** screen appears.
10. Press the **Shutter** button to exit **SET** mode.



4.12 Date and Time

This menu allows you to set the camera date and time settings. Do the following to set the camera date and time.

1. Press the **Mode** button repeatedly to change to **SET** mode.
2. Press the **Shutter** button to enter **SET** mode.
3. Press the **Mode** button to highlight **MORE**.
4. Press the **Shutter** button to enter the **MORE** menu.
5. Press the **Mode** button to highlight **TIME**.



6. Press the **Shutter** button to enter the **TIME** submenu. The Year is highlighted.
7. Press the **Shutter** button repeatedly to adjust the year.

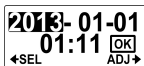

8. When done, press the **Mode** button to go to the month field.

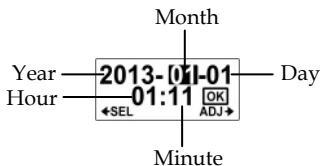

9. Press the **Shutter** button repeatedly to adjust the month value, and then press the **Mode** button to go to the day field.
10. Press the **Shutter** button repeatedly to adjust the day value, and then press the **Mode** button to go to the hour field.
11. Press the **Shutter** button repeatedly to adjust the hour value (in 24 hr or military time), and then press the **Mode** button to go to the minute field.
12. Press the **Shutter** button repeatedly to adjust the minute value, and then press the **Mode** button to highlight **OK**.
13. Press the **Shutter** button to complete the date and time setting.
14. To exit the menu, press the **Mode** button repeatedly until the **EXIT** screen appears.
15. Press the **Shutter** button to exit **SET**

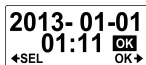

mode.

4.13 RF

This menu allows you to pair your camera with the RF watch remote control (optional accessory). When the devices are paired, you can record videos or capture photos by pressing the corresponding buttons on the RF watch remote control.

Do the following to pair your RF watch remote control.

1. Press the **Mode** button repeatedly to change to **SET** mode.
2. Press the **Shutter** button to enter **SET** mode.
3. Press the **Mode** button to highlight **MORE**.
4. Press the **Shutter** button to enter the **MORE** menu.
5. Press the **Mode** button to highlight **BINDING**.
6. Press the **Shutter** button to enter the **BINDING** submenu.



7. The camera RF antenna is enabled and ready to be paired with the RF watch remote control.

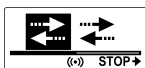

- **Note:** For details on pairing procedures with the RF watch remote control, see “RF Watch Remote Control” section or you can refer to *RF Watch Quick Start Guide*.

8. To exit the menu, press the **Mode** button repeatedly until the **EXIT** screen appears.



9. Press the **Shutter** button to exit **SET** mode.

4.14 Factory Default

This menu allows you to restore the default factory settings of your camera.

Do the following to restore the factory default settings.

1. Press the **Mode** button repeatedly to change to **SET** mode.
2. Press the **Shutter** button to enter **SET** mode.
3. Press the **Mode** button to highlight **MORE**.
4. Press the **Shutter** button to enter the **MORE** menu.
5. Press the **Mode** button to highlight **DEFAULT**.
6. Press the **Shutter** button to enter the **DEFAULT** submenu.



7. Press the **Mode** button to select ✓.



8. Press the **Shutter** button to confirm.
9. To exit the menu, press the **Mode** button repeatedly until the **EXIT** screen appears.
10. Press the **Shutter** button to exit **SET** mode.



5 Using the Accessories

The camera comes with rugged accessories for all your sporting needs.

5.1 Waterproof Case

The waterproof case allows you to take underwater shots or use it with the surface mount, bike mount, or chest strap to capture other water sports activities.

5.1.1 Using the Waterproof Case

1. Release the case lock and flip open the waterproof case.

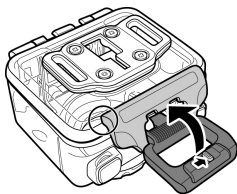

2. Install the camera inside the waterproof case.

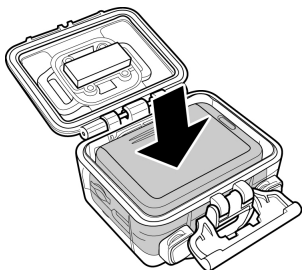

3. Secure the waterproof case lock.

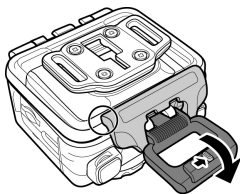

The waterproof case can be used with other accessories such as the swivel T tip, bike mount, chest mount, head mount, etc.

How to avoid fogging

1. Put 4 Anti-fog Inserts in waterproof case. Be sure to wait two hours at least before using underwater. After using the anti-fog inserts, they need to dry or put in electronic dry cabinet.

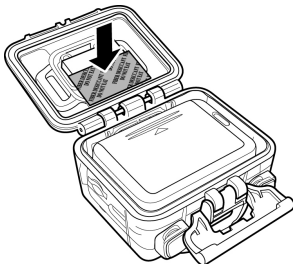

2. Use the fogging agent or toothpaste to spray inside the lens. Cross the water and left to dry to avoid fogging.
3. Put the camera with Li-ion battery in the waterproof case and don't close the case, then put them to the electronic dry cabinet for about two hours. Before you use the

machine, close the waterproof case in the electronic dry cabinet immediately. Don't open the waterproof case again to avoid humidity.

5.1.2 Changing the T Tip Adapter

Depending on the accessories that you want to use with the case, the T tip adapter may be detached and attached to another housing back door or location. To detach the T tip adapter, remove the four screws securing each tip adapter to the case.

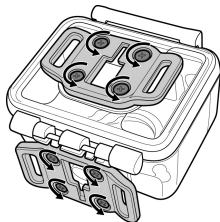

5.1.3 Changing the Housing Back Door

Depending on the accessories that you want to use with the case, you may need to change the housing back door. Two back doors are included in the standard package: the waterproof housing back door, and the vented housing back door.

Do the following to change the housing back door:

1. Open the back door completely.
2. Pull to detach the back door from the case.
3. Detach the T tip adapter from the current back door and install the T tip adapter to the back door you want to use.
4. Install the back door.

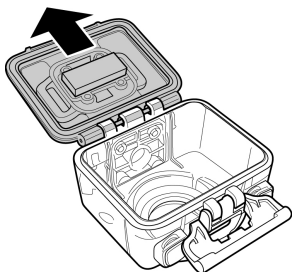

5.2 Velcro Strap

The Velcro strap can be used to secure the waterproof case onto any object to conveniently record photos and videos.

To install the Velcro strap, insert the strap through the strap holes of the tip adapter as shown below.

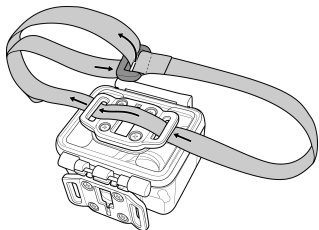

5.3 Assembling the Camera Accessories

Lock the T tip adapter to the T tip of the adjoining accessories to install them to your camera.

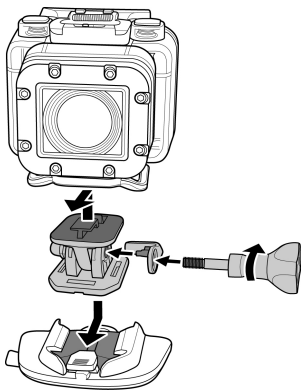

Tips on attaching adhesive mounts

- Apply to clean surfaces - wax, dust, and oily essence free.
 - Attach the mount at room temperature.
 - Mount only on smooth surfaces. To obtain optimum adhesion, firmly press into place when installing the mount.
 - It is highly recommended to attach the mount a minimum of 24 hours before its initial usage.
-
- To prevent falls or losing your device, install the safety lock onto the swivel T tip to secure the device position into place.



5.4 RF Watch Remote Control

Before using the RF watch remote control, you must pair it with the camera.

Do the following to pair your RF watch remote control.

1. On the camera, press the **Mode** button repeatedly to change to **SET** mode.
2. Press the **Shutter** button to enter **SET** mode.
3. Press the **Mode** button to highlight **MORE**.
4. Press the **Shutter** button to enter the **MORE** menu.
5. Press the **Mode** button to highlight **BINDING**.
6. Press the **Shutter** button to enter the **BINDING** submenu.



7. The camera RF antenna is enabled and ready to be paired with the RF watch remote control.

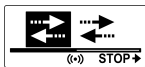

8. On your RF watch remote control, press the **MODE** button to switch to **Preview** mode. Then press and hold the **SET** button to enter to **SET** mode.

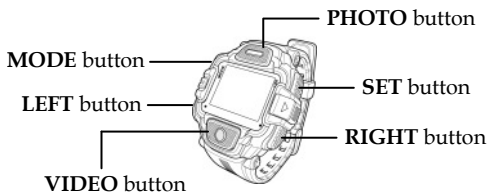

9. Use the **LEFT** or **RIGHT** button to select **Pairing** and press the **VIDEO** button to enter **Pairing** menu.
10. Use the **LEFT** or **RIGHT** button to select the preview window that you want to pair with your camera and press the **VIDEO** button to start pairing.

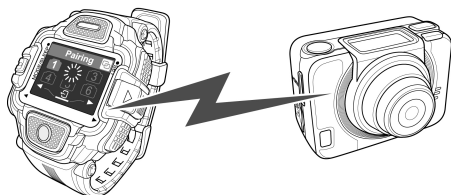

11. When pairing is complete, press the **SET** button to return to **SET** mode. Then press the **SET** button to switch to **Preview** mode.
12. Press the **VIDEO** button on your RF watch remote control to start and stop video recording. To take photos, press the **PHOTO** button.

▪ **Note:** The maximum operation distance of the remote control is approximately 3m when the RF watch remote control is pointed at the remote control sensor of the camera.

Appendix

Specifications

General	
OLED Screen Display	0.83"
Storage (Memory)	Micro SD card, up to 32GB SDHC Class 6
Image Quality	Optics: Ultra-sharp F/no=2.8, f=3.4mm Focus range: 0.8m ~ infinity Field of view: Ultra wide, Wide
Video	1080p (16:9): 60fps Ultra wide/30fps Ultra wide, Wide, Narrow FOV 960p (4:3): 60, 30 fps Ultra wide FOV 720p (16:9): 120, 60 fps Ultra wide FOV WVGA (16:9): 240 fps Ultra wide FOV Time lapse: 1, 3, 5, 10, 30, 60 seconds Video format: H.264 mp4
Still Image	Resolution: 16MP, 12MP, 8MP, 5MP Burst (Photo/sec): 7/1 Self-timer: 2, 10 seconds Interval shooting: 1, 3, 5, 10, 30, 60 seconds Photo format: JPEG (exif 2.2), DCF
White Balance	Auto
Wi-Fi Built-in	Yes
RF Remote Built-in	Yes
Looping Video	Yes, 1080p30 Ultra wide

General

High Video Bitrate Capture (H.264)	Up to 15 Mbps
Average Record Time	Video (1080p60): about 90 minutes, Photo (16MP): about 250 photos
Auto Power Off	1, 3, 5, 10, 30, 60 minutes
Inputs/Outputs	Micro USB, Mini HDMI, 2.5mm external microphone
Battery	1130mAh rechargeable Li-ion
Dimensions	42.7 (H) x 59.2 (W) x 26.4 (D) mm (without lens)
Weight	Approx. 74±3g (without battery)

Troubleshooting

Problem	Possible Cause	Solution
The battery LED is flashing red.	The battery is almost used up.	Replace with a new battery or charge the battery.
Nothing happens when the Shutter button is pressed.	The Micro SD card is full. You cannot take photos or record videos at this point.	Transfer the Micro SD card files to the computer or delete the files in the Micro SD card.
Nothing happens when the Shutter button is pressed. "000" appears on the screen.	The Micro SD card may have compatibility issues.	Format the Micro SD card first using the camera (Delete menu). If it still does not work, format the Micro SD card using the PC.
Nothing happens when the Shutter button is pressed. "000" appears on the screen.	The Micro SD card is not inserted.	Insert the Micro SD card.

FCC Statement

Modifications not approved by the party responsible for compliance could void user's authority to operate the equipment.

This equipment has been tested and found to comply with the limits for Class B digital device, pursuant to part 15 of the FCC Rules. These limits are designed to provide reasonable protection against harmful interference in a residential installation. This equipment generates and can radiate radio frequency energy and, if not installed and used in accordance with the instructions, may cause harmful interference to radio or television reception, which can be determined by turning the equipment on and off.

The user is encouraged to try to correct the interference by one or more of the following measures:

- Reorient or relocate the receiving antenna.
- Increase the separation between the equipment and the receiver.
- Connect the equipment into an outlet on a circuit different from that to which the receiver is connected.
- Consult the dealer or an experienced radio/TV technician for help.

Radiation Exposure Statement

The product comply with the FCC portable RF exposure limit set forth for an uncontrolled environment and are safe for intended operation as described in this manual. The further RF exposure reduction can be achieved if the product can be kept as far as possible from the user body or set the device to lower output power if such function is available.

NOTE

Please use microSD cards up to 32GB, minimum Class6 (not included).

Recording times are depending on resolution.

Before using your camera in the water please verify that all lids and locks are tightly closed and sealed on the camera and the underwater case. After use, clean the housing of salt and chlorine water and then let it dry.

The camera should not be exposed to large temperature and humidity differences to avoid condensation inside the housing or behind the lens. After underwater use, the case must be kept open to avoid condensation or rust.

DECLARATION OF CONFORMITY

easypix hereby declares that the product GoXtreme WiFi Pro is in conformity to all the essential requirements of Directive 1999/5/EC. The declaration of conformity can be downloaded here:
http://www.easypix.info/download/pdf/doc_goxtreme_wifi_pro.pdf

For technical help please visit our support area on www.easypix.eu.



 *Only EU*

easypix[®]
LIFESTYLE ELECTRONICS