

GOXTREME[®]
ACTION CAMS

GOXTREME[®]
FULL DOME 360[°]

2x 360° PANORAMA & VIRTUAL REALITY CAMERA

Thank you for purchasing the GoXtreme Full Dome 360°.

This 360° camera allows you to capture, view and share amazing full panoramic 360° videos and photos. When viewed using the companion app or desktop viewer your videos and images become interactive, allowing you to experience everything just like being there all over again.

Important

- Before using this product, please read this manual carefully
- Please ensure your memory card is formatted by using the 'Format' option in the settings menu
- A full charge is recommended before use – please charge the camera until the indicator light switches off.
- To download the free app please scan the QR Code on next page, or search for “SYVR360” on Apple Store and Google Play.

About Camera

1. LCD display
2. Power button/Mode button
3. WIFI indicator (red)
4. Power indicator (red) / Charging indicator (blue)
5. WiFi button / MENU button
6. Busy indicator (red)
7. Shutter button / OK button
8. Lens 2x
9. Triangle nut
10. Interface cover (USB/TF)
11. Speaker
12. Microphone
13. Rope hole
14. Reset hole

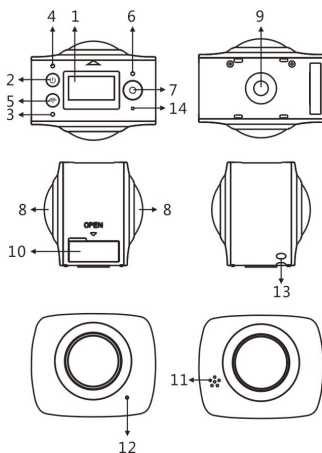

Preview & Remote App for mobile devices:

For the iOS system, please scan this QR Code to access the Apple App Store to download and install “SYVR360”.



or for the Android system, please scan this QR Code to get access to the Google Play store to download and install “SYVR360”.



Quick start guide

1. Install SD card:

Insert the Micro SD card into the slot as indicated, as shown on the right. Please ensure the pins on the memory card are facing upwards as shown.

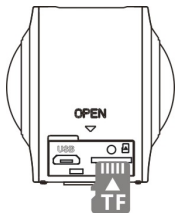

Important:

- To ensure smooth operation and file transfer, a high-speed Micro SD card between Class 6~Class 10 is recommended.
- Always turn off the camera before inserting or removing the memory card.

2. Power-on/off

Power-on: Press and hold the Power button for about 2 seconds and release when you hear a beep. The display screen will be appear as shown below, indicating the product is ready to use (the default mode after powering on is Video Recording mode).



Important:

- If the camera fails to turn on please charge the camera , ensuring that the blue indicator lights up during charging as this confirms that the product is being charged.

Power-off: Press and hold the Power button for about 3 seconds and release. The Display will display “GOODBYE” and turns off. Please note that the camera has a power save mode which is set to automatically turn the camera off after 3 min. of no operation. This can be adjusted or deactivated in the settings menu.

3. Charging

Please use the data cable included in the product pack to charge the camera from a laptop or desktop computer. During charging, the indicator displays in blue and lights constantly; when charging is completed, the blue indicator turns off.

Important:

- If other chargers are used, please ensure the output power is within the following range before use: 5V/0.5A ~ 5V/2.0A.

4. Recording or shooting

This camera has a **Recording** (video) mode and a Shooting (photo) mode. After turning on, quick press the MODE (Power button) to switch between different modes, and the corresponding mode icon will be displayed on the screen. (a beep will confirm your button press)

Video: In Recording mode, press the Shutter button to start recording. The display screen displays the elapsed video recording timing.

After reaching a max. video recording time of 29 minutes the camera will automatically stop. It can only be restarted manually.



Stop recording: During recording, press the Shutter button to stop recording. The video will automatically save on your memory card. At that moment, the display screen will show remaining time available for recording as below, as determined by the space remaining on the card.



Shooting: In Shooting mode, press the Shooting button to take photos. After shooting, the display screen will show the number (estimated value) of additional pictures that can be saved to the memory card.

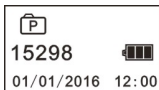

5. Menu setting

To enter the settings menu, press and hold the WIFI button for about 2 seconds (as shown below):

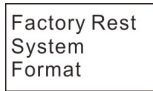
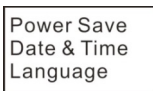

Menu operation:

In Menu mode, press the WIFI button to move the cursor. Press the Shutter button to confirm your selection. Press and hold the WIFI button to navigate back to the previous menu or to exit Menu mode.

Explanation of menu functions:

Power Save: Set Power-save mode. You may set the camera to automatically turn off after a preset period of time in order to save battery.. The available options are 1min/3min/5min or Power-save mode off.

Date & Time: Sets the time and date in the cameras system..

Language: Sets the menu language for the camera. This is set to English by default.

Factory Reset: Restores the camera to it's original factory default settings.

System: Check system and storage card information.

Format: Formats the Micro-SD card. This operation is recommended when using any card with the camera for the first time.

Important:

After formatting, all existing data on the storage card will be lost due to due to the formatting process. Please ensure any data already on the card is backed up in advance of commencing the formatting operation.

6. How to use accessories properly

In order to deliver a better user and product experience it is recommended to use the accessories originally provided by the manufacturer.

Tripod: Screw the tripod nut attached into the screw hole on the bottom of the camera. This serves both as a hand-held or fixed device.

Fix to use tripod

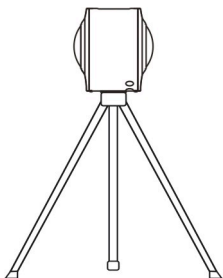

Hold to use tripod

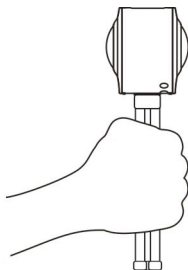

Playback of panoramic video or picture

Note: The videos or pictures may be played with the correct panoramic effect using only a smartphone, tablet computer or a PC or Mac laptop or desktop computer.

1. Use mobile phone or panel computer to play

Follow these steps to play panoramic videos or pictures on mobile phone or tablet.

Download the Preview & Remote App:

Scan QR Code on Page 4 or search for “SYVR360” on the App Store or Google Play to download and install the product app.



store

Connecting your phone or tablet to the camera: Your smartphone or tablet connects to the camera using the camera WiFi connection.

- i. Turn on the camera WIFI: Press camera WiFi button, and the display screen will display “WiFi ON”, and then “FullDome360”, The password for initial pairing is “1234567890”.

* This password is only required when pairing for the first time.



- ii. Turn on your mobile phone or tablet WiFi, and search for the WiFi connection name “FullDome360” and select Connect.



- iii. If connected, the camera display screen will display as shown below.



Activate the app: Activate the “SYVR360” app on your mobile phone or tablet, and click the camera icon in the upper right corner to “Search for your Camera”. Once connected a ‘live view’ will display on your phone.

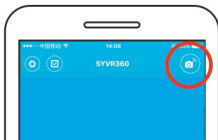

Download: Enter the camera folder, select the file to be downloaded and click to download.

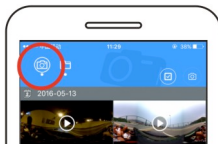

Play: Select the file on mobile phone and click to play.

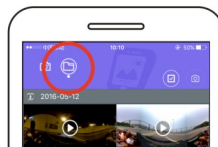

Important

It is recommended to follow the above steps in order to achieve the best HD video or picture playing effect. Before connection, please ensure the SD card is properly inserted into the camera.

While connected the 4G communication function of the mobile phone or tablet will not be affected.

**Please note that the use of any other app to view images captured with your camera will result in images being incorrectly displayed as below.*



Effect of panoramic playing

The following effects are available if played on APP player

Planet mode

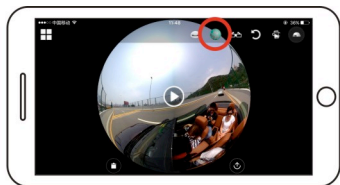

Plane mode



VR mode

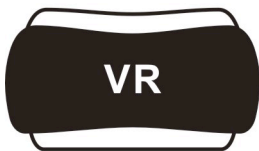

2. Using a PC or laptop computer for playback

You may use your PC or laptop as an alternative playing experience, or to edit and share videos. It can be completed by following the steps as shown below:

Download the SYMAX360 Player:

www.easypix.info/download/symax360.zip

**Please note that the use of any other software to view images captured with your camera will result in images being incorrectly displayed as below.*

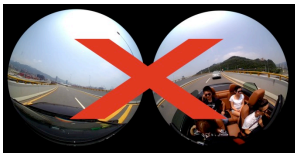

Download video or picture onto PC:

- Use the USB data cable included with your camera to connect the camera and computer. After connection, the camera display screen will display “MSDC”.



- Open “My computer” to select “VIDEO” OR “JPG” folder under “Removable disks”. Select the file to be downloaded and download it into location specified on PC.

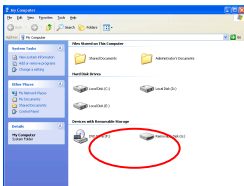

Run SYMAX360 Player:

Open your chosen 360° photo or video using this player.



Playback video with SYMAX360 Player:

When playing the video, use the mode icons in the top right corner to select the different playback views. (Plane/Planet/Invert). Clicking these icons will select the different effects. While playing, place the mouse over the image and click to move around within the 360° panoramic image.

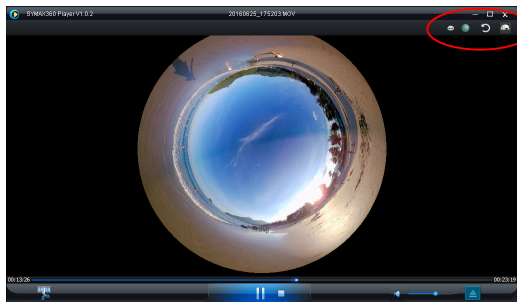

Sharing videos online:

Before sharing your 360° panoramic videos on social media sites such as Facebook and You Tube your videos must be converted to a compatible format in order to be viewed properly online.

Please use the conversion tool included in the desktop app to complete this process.

Important:

On current video websites, the videos uploaded by users have been compressed automatically. This may lead to a difference in the appearance of video playback between videos viewed online and on your computer.

Technical data:

Image sensor	2x 4.0M (CMOS)
Function modes	Recording (Video) & Shooting (Photo)
Lens	F2.0 f=1.1mm / 2x 220° wide angle
Video resolution	1920x960 (30fps)
Picture resolution	3008x1504
File format	Video: H.264 (MOV) Image: JPG
Storage medium	Micro SD up to 32GB – Class 10 minimum
USB interface	High-speed USB2.0 interface
Power supply	Built-in high voltage lithium battery 1500mAh
Size	60x45x47mm

Instructions for use

- The product is equipped with a built-in battery. Do not put it directly into a fire as this may result in an explosion or other dangers.
- The product may radiate heat due to long-term use or exposure to direct sunlight. This is normal.
- If the camera stops working or fails to respond to any operation during use, use a needle to press and hold the Reset button for up to 3 seconds to restart the product.
- Do not use the camera in any environment with temperatures lower than 0°C or higher than 40°C as the camera not turn on normally.
- Do not use the camera in humid conditions, as the humidity may damage important components within the camera.
- Do not put the camera directly into water.
- Do not use the camera during charging, as this may cause the operating system to fail due to improper heat radiation.
- To avoid damage do not expose the lens to contact with hard or abrasive materials.

DECLARATION OF CONFORMITY

Easypix hereby declares that the product GoXtreme Full Dome 360° is in conformity to all the essential requirements of Directive 1999/5/EC.

The declaration of conformity can be downloaded here:

http://www.easypix.info/download/pdf/doc_goxtreme_fulldome360.pdf

For technical help please visit our support area on www.easypix.eu.



Only EU

easypix[®]
LIFESTYLE ELECTRONICS