

easypix®

DVC2712 *Cruiser*

User manual

Functions & Features

The digital camcorder has various features and functions:

- Digital Video
- Digital Camera (5 million pixels)
- 2.7" resistive touch screen
- Mass Storage (Removable disk)
- PC Digital Video (Camera)
- 8x digital zoom

Accessories

You will find the following main accessories after opening the package:



USB connector



Installation CD



TV cable

Introduction

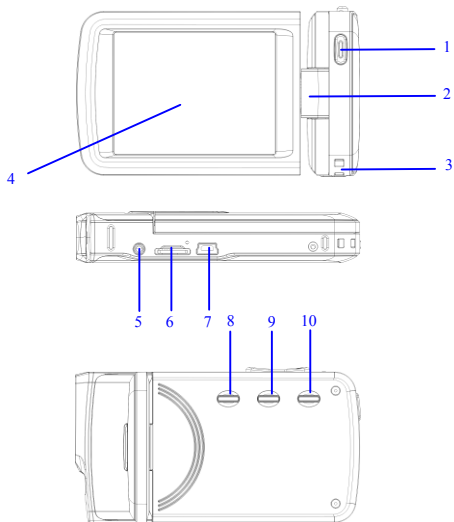

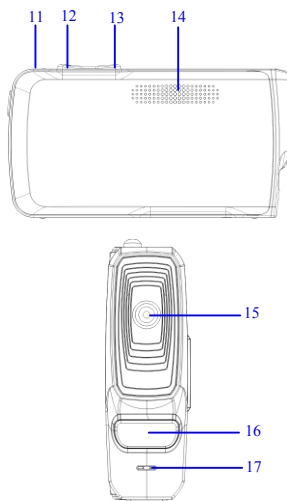

(1) Shutter key (2) Shaft (3) Hang rope buckle (4) Display screen (5) AV port
(6) TF card slot (7) USB port (8) Power key (9) Mode switch key (10) Menu
key (11) Charger light (12) W key (13) T key (14) Loudspeaker (15) Lens (16)
LED fill light (17) Microphone

Camera key press functions and indicators

Press/Indicator	Functions
Power key	Turn the digital camcorder on/off
Shutter key	Video mode, record video/stop recording, shooting mode, act as a shutter
T key	Digital enlargement and digital zoom, select document by pressing left (playing back mode). Press up to select menu. After opening menu, the volume will be turned up (when display video);
W key	Digital lessen and digital zoom, select document by pressing right (playing back mode). Press down to select menu. After opening menu, the volume will be turned down (when display video);
Menu key	Open/exit menu. Stop playing (when playing back)
Mode switch key	Switch among 3 modes—video recording, shooting and playing back, such 3 modes. Press this key to enter pc cam mode after connecting computers
Working indicator	If DV is power off, charging it by USB, the light will bright

Start Using

Battery

The digital camcorder is built-in rechargeable 3.7V lithium batteries.

Charge your DV with the USB cable

Insert Memory Card

Insert a TF memory card in the memory card slot with the metal pins towards inside in light of the prompts next to the card slot.

To remove the memory card, press the TF memory card downwards, and then remove it.

Note: ● Turn the power off before replacing the memory card.



- Insert cards in correct direction. Do not insert cards with large force to avoid damaging cards or any part of the digital video. If failed, check whether the direction is correct.
 - Format any new memory card or the one used in other digital camcorders before using it in your digital video.
-

Open Screen



Open the LCD to let it face towards yourself.

Turn Digital Camcorder on

Press Power key to turn the digital camcorder on.

Switch Mode

In video recording mode, press Mode key to switch from the current mode to the shooting mode, and then press this key again to switch to playing back mode, in which press this key again to return to the video recording mode.

In the video recording mode, tap  icon on the touch screen to enter the shooting mode, in which tap  icon to enter the playing back mode, in which tap  icon to return to the video recording mode.

Record Video

In video recording mode, press Record key to start recording; press it again to stop.

Tap the center of the touch screen once to start recording; press it again to stop.

Shoot

In the shooting mode, press Shoot key to take photos.

Tap the center of the touch screen once to start shooting.

Self-timer mode: start countdown after pressing the Shoot key. Take one photo after delaying 2s or 10s.

Use the LED fill light: Please press the icon 'D' on the screen to turn on the LED fill light, then screen will show another icon 'D' (LED fill light couldn't be used when playing back)"









NOTE: Keep the digital camcorder stable while shooting.







Playback

Press Mode key to enter the playing back mode, in which it is able to view photos/videos, play videos recorded by the digital camcorder.

View photos: use Left key or Right key to select photos/videos. Use Zoom In key to enlarge photos, and then tap '▲' '▼' '◀' '▶' on the touch screen to move photos. Use Zoom Out key to enter the thumbnail mode.

Tap  or  icons on the touch screen to select photos/videos; tap  icon to enter the thumbnail mode, and then tap  or  keys to turn pages up or down; tap  icon to play slides of photos.

Play video: use Left/right keys to select targeted videos, and then press Shutter key to play. Press this key again to stop playing. During playing, press OK key to suspend, and then press such key again to continue playing.

After selecting videos, tap  icon to play it. Tap  key to suspend playing; tap  icon to continue playing. Tap  icon or  icon to skip backwards or forwards respectively. Tap  icon to stop playing.

In the playing back mode, press DISP key once to playback the vehicle-mounted loop video recording (vehicle travel records).

TV Output

To input pictures and voice recorded by the digital camcorder to a TV, insert the common port of the TV cable into the TV port of the digital camcorder.

Connect the yellow port with the video input port of the video equipment, as well as red/white port with audio input port. Note: stop recording video/audio or playing before connecting TV or pulling TV cable out.

Turn off

In the power on status, press and hold Power key to turn the digital camcorder off.



In the idle mode, and beyond the time preset for auto power-off (1m/3m/5m/OFF), the digital camcorder will turn off automatically to save power.



NOTE: ●If setting auto power off on "OFF", the camera will not power off automatically until the power is low.

Menu Settings

In the shooting/video recording/playing back modes, press Menu key to open the menu, and then press Up/Down/Left/Right key to select menus, then press OK key to enter sub-menu. When selecting menus, the background color of selected menu will display.

Note: it is able to open menus by tapping **MENU** icon on the touch screen in the shooting/video recording/playing back modes. Tap  or  icons on the menu interface to switch to the next page.

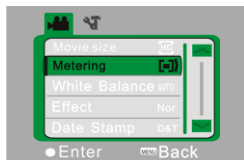

▲ Record Video Menu

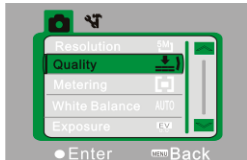



▲ Shoot Menu

Date & Time Settings

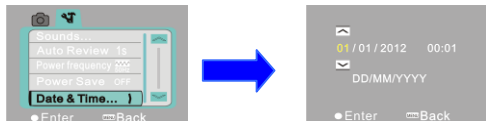
Press Menu key to open the menu, and then press Left/Right keys to enter Setting menu. Press Down key to select the option of Date & Time, and then press OK key to enter the setting interface.



In the setting interface, press Left/Right keys to select items to be adjusted (date or time). The button icon will be shown on the up/down edges of selected items. Press Up/Down keys to adjust (or tap $\overline{\quad}$ or $\underline{\quad}$ icons to adjust). After adjustment, press OK key or tap  Enter icon on the screen to confirm. Finally, press Menu key (or tap  Back icon on the screen) to exit from the setting mode.

Connect to computer

Before connecting with computer, install the digital camcorder driver by installation CDs. Turn the digital camcorder on, and then use USB cable to connect the digital video with an available USB port on the computer. The USB mode is as removable hard disk or camera. The digital camcorder will enter the removable disk mode automatically. Press Modes Switch key to enter the camera mode.

Advanced Operation

Video Recording Mode

After being turned on, the digital camcorder will enter the video recording mode automatically.

Press Shutter key to start recording, and press such key again to stop recording.

After reaching a max. video recording time of 29 minutes the camera will automatically stop. It can only be restarted manually.

Tap the icon ‘D’ on the touch screen to open/close the LED fill light (the fill light is unavailable in the playing back mode).

□ The information will be shown on the screen in the video recording modes.

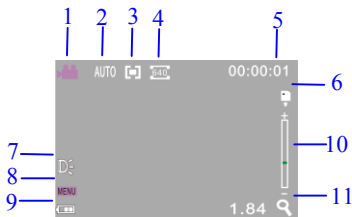

No.	Icon Name	Description
1	Video mode	It indicates that it is able to recording video by pressing Shutter key in the video recording mode.

2	White balance	It indicates the current settings for white balance.
3	Metering mode	It indicates current metering mode.
4	Video format	It indicates current video resolution.
5	Recording time	The free time indicates the remaining available recording time; the recording time indicates the recorded time.
6	TF card	The  icon indicates to insert the memory card.
7	The power on/off for LED fill light	Tap it on the touch screen to turn on/off LED fill light.
8	Menu key on The touch screen	Tap it to open the menu.
9	Power	It indicates current power status. In red color, it means the power is depleted, and the camera will turn off automatically.
10	The progress of Zoom	It indicates the current progress for digital zoom.

11	Zoom instruction	It indicates the current times for digital zoom.
----	------------------	--

□ Menu Settings for video recording

Press Menu key to open Video recording. Press T/W key to select menus, and then press shutter key to enter sub-menus. Press Menu key or OK key to return to the main menu. Press T/W key to select, and the press SHUTTER key to confirm. After returning to the main menu, press Menu key to exit.

It is possible to operate the settings for menus directly via the touch screen.

Options of Video Recording Menu:

Main Menu	Sub Menu	Description
Video mode	1920x1080	High resolution scheme
	1280x720	Medium resolution scheme
	640X480	Low resolution scheme
Metering mode	Central metering	It subjects to the central area when metering.
	Multi-spot metering	It subjects to multi spots when metering

	Spot metering	It subjects to one spot when metering
White balance	Auto	It is fit for many conditions.
	Day light	It is fit for day light circumstance.
	Cloudy day	It is fit for cloudy circumstance.
	Fluorescent lamp	It is fit for fluorescent lamp circumstance.
	Tungsten lamp	It is fit for tungsten lamp circumstance.
Special effects	Normal	Normal effect
	Black & White	Black & White effect
	Return to the ancients	Return to the ancients effect
	Negative film	Negative film effect
	Red	Partial red effect
	Green	Partial green effect
	Blue	Partial blue effect
Date stamp	Disable	Disable the function of printing date/time on files.

	Date	When shooting/video recording, the date will be print on the lower right corner of files.
	Date & Time	When shooting/video recording, the date and time will be print on the lower right corner of files

Shooting Mode

After being turned on, the digital camcorder will enter the video recording mode automatically, please press Mode Switch key to enter the shooting mode.

In the shooting mode, press Shutter key to take photos.

In the video recording /shooting mode, press T/ W key to conduct the digital zoom.

Tap the icon ‘**D**’ on the touch screen to open/close the LED fill light (the fill light is unavailable in the playing back mode).

The information will be shown on the screen in the shooting/ video recording modes.



No.	Icon Name	Description
1	Shooting mode	It indicates that it is able to take photos by pressing Shutter key in the shooting mode.
2	Countdown for self-timer	It instructs the countdown for self-timer.
3	White balance	It indicates the current settings for white balance.
4	Metering mode	It indicates current metering mode.
5	Exposure	It indicates current exposure value.
6	Picture size	It indicates current resolution of photos
7	Picture quality	It indicates current selected picture quality.

8	Available numbers of photos	It indicates the remaining numbers of photos available to be taken.
9	ISO	It indicates current ISO setting.
10	The power on/off for LED fill light	Tap it on the touch screen to turn on/off LED fill light.
11	Menu key on the touch screen	Tap it to open the menu.
12	Power	It indicates current power status. In red color, it means the power is depleted, and the digital camcorder will turn off automatically.
13	TF card	The  icon indicates to insert the memory card.
14	The progress of Zoom	It indicates the current progress for digital zoom.

15	Zoom instruction	It indicates the current times for digital zoom.
----	------------------	--

□ **Menu setting for shooting mode**

Press Menu key to open Shooting menu. Press T/W key to select menus, and then press shutter key to enter sub-menus. Press Menu key or OK key to return to the main menu. Press T/W key to select, and the press SHUTTER key to confirm. After returning to the main menu, press Menu key to exit.

It is possible to operate the settings for menus directly via the touch screen.

Options of Video Recording Menu:

Options of shooting menu:

Main Menu	Sub Menu	Description
Picture size	4000 x 3000	12 million pixels resolution
	3264 x2448	8 million pixels resolution
	2592x1944	5 million pixels resolution
	2048x1536	3 million pixels resolution
	1280x1024	1 million pixels resolution

Picture quality	Excellent	Excellent picture quality
	Good	Good picture quality
	Normal	Normal picture quality
Metering mode	Central metering	It subjects to the central area when metering
	Multi-spot metering	It subjects to multi spots when metering
	Spot metering	It subjects to one spot when metering
White balance	Auto	It is fit for many conditions.
	Day light	It is fit for day light circumstance.
	Cloudy day	It is fit for cloudy circumstance
	Fluorescent lamp	It is fit for fluorescent lamp circumstance
	Tungsten lamp	It is fit for tungsten lamp circumstance.
Exposure	/	Use Left/Right key to adjust the compensation for exposure.

Shooting mode	off	Use the normal single photo shooting mode
	2s	Use the 2s delayed self-timer mode.
	10s	Use the 10s delayed self-timer mode.
	Continuous shooting	Continuous shooting
Special effects	Normal	Normal effect
	Black & White	Black & White effect
	Return to the ancients	Return to the ancients effect
	Negative film	Negative film effect
	Red	Partial red effect
	Green	Partial green effect
	Blue	Partial blue effect
Date stamp	Disable	Disable the function of printing date/time on files

	Date	When shooting/video recording, the date will be print on the lower right corner of files.
	Date & Time	When shooting/video recording, the date and time will be print on the lower right corner of files.
ISO	AUTO	Set ISO value as Auto
	ISO 100	Set ISO value as 100
	ISO 200	Set ISO value as 200
	ISO 400	Set ISO value as 400

Playing Back Mode

After being turned on, the digital camcorder will enter the video recording mode automatically. Press Mode key to enter shooting mode. Under photograph mode, press Mode key again to enter playing back mode. Under playing back mode, press T or W to scan photo or video left or right.

- ◆ Display information on playing back mode screen

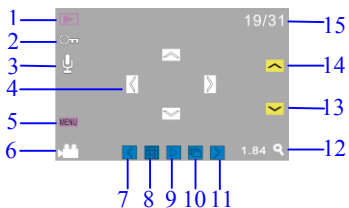

No.	Icon name	Description
1	Playing back mode	Indicates in playing back mode
2	Document protection	Indicates current document has been locked to protect.
3	Voice memo	Indicates current document has added voice memo
4	Translational icon	After enlarging photo, click four icons including up, down, left and right on screen to realize translational scan photo.
5	Menu	Click the icon on screen to open menu
6	Video icon	Indicates current document is video document.
7	Left icon	Click this icon to select document to left.
8	9 grid icon	Click this icon to enter 9: picture scan.

9	Display icon	When current document is photo, click this icon to enter photo enlargement state; when current document is video, click this icon to display video.
10	Slide	Click this icon to display slide automatically.
11	Right icon	Click this icon to select document to right.
12	Enlargement times	Indicates enlargement times in enlarging photo.
13	Next page	When in 9: picture scan, click this icon to view next page.
14	Previous page	When in 9: picture scan, click this icon to view previous page.
15	Document quantity	Indicates there are currently 31 documents, you are scanning 19th document.

Menu Settings for Playing Back Mode

Press Menu key to open the main menu, and then press Up/Down keys to select. Press OK key to enter the sub-menus. Press Menu key or OK key to return to the main menu. Press Up/Down keys to select, and then press OK key to confirm. After returning to the main menu, press Menu key to exit.

Note: it is able to tap **MENU** icon on the touch screen to open and set menus.



Options of Playback Menu:

Main Menu	Sub Menu	Description
Lock files	Lock/unlock this file	Lock/unlock current files
	Lock all files	Lock all files
	Unlock all files	Unlock all files
Delete files	Delete this file	Delete current file
	Delete all files	Delete all files
Play slides	Start	Start to play slides
	Interval	1s~10s
	Loop	Yes/No

Voice memo	Add	Add voice memo to photos
	Delete	Delete voice from photos

Note: It is able to add voice memo up to 30s to every photo. In the playing back mode, photos with voice memo will have  icon. Press OK key to start to play voice memo, during which press Up key to suspend playing or press Menu key to stop playing.

Setting menu

Under any mode (video, photograph or playing back), press Menu key to open menu, and then press Mode key to enter setting menu. Under setting menu, press T or W to select menu up or down, press Shutter key to confirm to enter submenu. Under submenu, press T or W to set, press Shutter to confirm to save setting and then back to main menu or directly back to main menu by pressing Menu key to cancel setting. After backing to main menu, press Menu key to exit menu.

Note: you can also click the icon **MENU** on touch screen to open menu. Menu setting can be operated on touch screen directly.

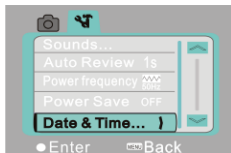

▲ Setting menu

Main Menu	Sub Menu	Description
Sound	Shutter	On/off
	Starting up tone	No/1/2/3
	Key tone	On/off
	Volume	0/1/2/3
Auto playback	Off	No playback after shooting
	1s	Playback 1s after shooting
	3s	Playback 3s after shooting
Power frequency	50Hz	Set light source frequency as 50HZ
	60Hz	Set light source frequency as 60HZ
Auto power off	1 min	Auto power off after being in idle status for 1 min.
	3 min	Auto power off after being in idle status for 3 min.
	5 min	Auto power off after being in idle status for 5 min.



	OFF	Disable the function of auto power off.
Date & Time	/	Set date & time, together with the date format
Language	English	Set the menu language as English
	Français	Set the menu language as French.
	Español	Set the menu language as Spanish.
	Italiano	Set the menu language as Italian.
	Português	Set the menu language as Portuguese.
	Deutsch	Set the menu language as German.
TV	NTSC	Set television system as NTSC
	PAL	Set television system as PAL
Format	Yes/No	Format the memory card.
Restore factory settings	Yes/No	Restore the factory settings

Connect Computers to Download Photos/Videos

After connecting the digital camcorder with a computer and entering the removable disk mode, there will be a new removable disk in My Computer interface. Any shot photos or recorded video will be stored under the directory “DCIM\100MEDIA” in the removable disk. It is able to enter such directory to copy files to your computer hard disk.

Note: do not disconnect USB connection during files download. Do not insert or remove memory cards during USB connection to avoid data loss.

Using the camera

After connecting the digital camcorder with a computer, press Mode Switch key to enter the Camera mode. Before using the camera, it is necessary to ensure that the digital camcorder driver has already been installed on the computer. After installation, there will be a new “SPCA1628 PC Driver” menu under “Start → All Programs” menu. Under this new menu, there is a shortcut icon  Amcap . After connecting the digital video with a computer and entering the camera mode, press  Amcap icon to open the AMCAP interface, in which the video captured by the lens will be displayed. Without the AMCAP software, it is able to send videos via networks by the camera.

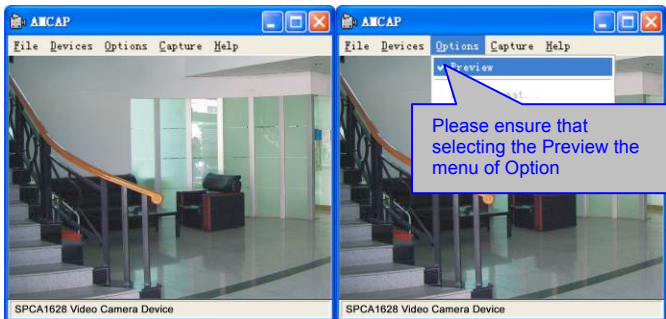

Installing driver and software

The accessory CD contains the camera driver and provided software **MAGIX Video easy SE / MAGIX Photo Manager MX** (for photo and video processing).

Installation interface

Please insert the CD into the CD-ROM, the system will automatically run the installer in the CD, and the screen shows the installation wizard window as below.



(The installer may take several seconds to start, depending on the PC performance. If the installation window doesn't appear, please run "Windows Explorer", and select "autorun.exe" in the CD.)

Installing driver

In the installation wizard window, click the "Install Driver" button and follow the wizard to install step by step.

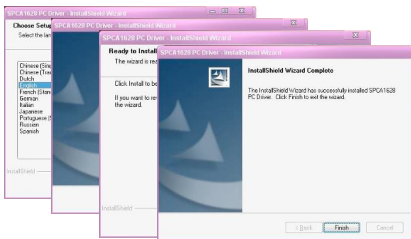

Please restart the PC after installing the driver.

Run the software MAGIX Video easy SE / MAGIX Photo Manager MX, click the button in the wizard window and follow the prompt to install step by step.

For usage, please click the "User Manual" button in the installation wizard window.

Specification

Image sensor	5 million pixels CMOS image sensor
Photo resolution	12M (4000 x 3000), 8M (3264 x 2448), 5M (2592 x 1944), 3M (2048 x 1536), 1M (1280x1024)
Memory Card	External TF card (4GB to 32GB)
File format	JPEG, AVI
Video resolution	FHD1920x1080, HD 1280X720, VGA 640×480
Self-timer delay	2 s / 10s
Digital Zoom	8 times
White balance	Auto / Sunny day / Cloudy day / Fluorescent lamp / Tungsten lamp
Exposure compensation	-2.0 ~ +2.0
USB port	USB2.0
TV output	NTSC / PAL
Display screen	2.7"resistive touch screen
Power	One 3.7V rechargeable lithium battery
Language	English/ Simplified Chinese/ French/ Spanish/ Italian/ Portuguese/ German

Focus distance	f=5.8mm
Aperture	F2.8
Auto power off	1 min / 3 min /5 min/OFF
Operating system requirements	Microsoft Windows 7, 2000,XP,VISTA
Size	110.5 mm × 55.7 mm × 21 mm

Note: The design specification of the product was formulated according to the latest information when compiling this instruction. There is no prior notice for any modification. Please refer to the actual digital video.

FAQ

The camera fails to start up after installing batteries	There is not enough power, please replace batteries.
	Do not remove the battery package
	Install batteries in wrong direction. Please check whether the battery has been installed correctly.
Fail to take photos or record videos after pressing the Shutter key	The internal memory is full. Please store shot files in other storages.
The photo is vague.	Please keep the digital video stable. Do not shake the digital camcorder when shooting.

The photo or video is dim.	There is not sufficient light when shooting. So please shoot in circumstance with full light or use lamps to increase the brightness of light.
The camera turns off automatically.	There is not enough power, please replace batteries.
	To save power, the digital camcorder will turn off automatically after being in idle mode for more than 1min (3min or 5min, according to various settings).
Fail to delete files in the digital video	The function of file protection is enabled. Please disable such function in Camera menu.

DECLARATION OF CONFORMITY

easypix hereby declares that the product DCV2712 is in conformity to all the essential requirements of Directive 1999/5/EC. The declaration of conformity can be downloaded here:

http://www.easypix.info/download/pdf/doc_dvc2712.pdf

For technical help please visit our support area on www.easypix.eu.



Only EU

easypix®
LIFESTYLE ELECTRONICS