

Preface

Congratulations on your purchase of this advanced digital camera / video, which is also a music player. Ensure that you read this manual carefully and keep it in a safe place for future reference.

About this manual

Every effort has been made to ensure that the contents of this manual are correct and up-to-date. However, no guarantee is made regarding the accuracy of the contents, and the manufacturer reserves the right to make changes without notice.

Copyright

© Copyright 2006.

All rights reserved. No part of this publication may be reproduced, transmitted, transcribed, stored in a retrieval system or translated into any language or computer language, in any form or by any means, electronic, mechanical, magnetic, optical, chemical, manual or otherwise, without the prior written permission of the manufacturer.

Safety

- Do not use or store the product in dusty, dirty, or sandy areas, as its components may be damaged.
- Do not store the product in hot areas. High temperatures can shorten the life of electronic devices, and warp or melt certain plastics.
- Do not store the product in cold areas. When the product warms up to its normal temperature, moisture can form inside, which may damage the electronic circuits.
- Do not attempt to open the casing.
- Do not drop or knock the product. Rough handling may damage the internal components.
- Do not use harsh chemicals, cleaning solvents or strong detergents to clean the product. Wipe the product with a soft cloth slightly dampened.
- If the product or any of its accessories are not working properly, take them to your nearest qualified service center. The personnel there will assist you, and if necessary, arrange for the product to be repaired.

Table of contents

<i>Preface</i>	<i>i</i>
<i>About this manual</i>	<i>i</i>
<i>Copyright</i>	<i>i</i>
<i>Safety</i>	<i>ii</i>
1 Introducing the Camera	1
1.1 System requirements	1
1.2 Features	1
1.3 Unpacking	2
1.4 About the camera	3
1.4.1 Front view	3
1.4.2 Right view	3
1.4.3 Left view	4
1.4.4 Top view	4
1.4.5 Bottom view.....	4
1.4.6 Button functions.....	5
1.4.7 Rotating the LCD monitor	6
2 Getting Started	7
2.1 Charging	7
2.2 Installing an SD card	8
2.3 Turning on/off the camera	8
3 Using the Camera	9
3.1 Using the LCD display	9
3.2 About the LED	9
3.3 Setup menu	10
3.3.1 Sound effect	10
3.3.2 USB mode	10
3.3.3 Date and time	11
3.3.4 Welcome picture.....	11
3.3.5 Auto power off	11
3.3.6 LCD brightness.....	11
3.3.7 Language	12

3.3.8	TV system	12
3.3.9	Format	12
3.3.10	Default	12
3.4	<i>Setting menu</i>	12
3.4.1	Video mode setting	13
3.4.2	Photo mode setting	14
4	Preview mode	17
4.1	<i>Preview mode icons</i>	17
4.2	<i>Using the self-timer function</i>	18
4.3	<i>Setting the Flash mode</i>	18
4.4	<i>White balance</i>	19
4.5	<i>Using the zoom function</i>	19
5	Shooting your first video	20
5.1	<i>DV mode settings</i>	20
5.2	<i>Using the zoom function</i>	20
5.3	<i>Using the self-timer function</i>	20
6	Taking your first picture	21
6.1	<i>Photo mode settings</i>	21
6.2	<i>Using the zoom function</i>	21
6.3	<i>Setting the Flash mode</i>	21
6.4	<i>Using the self-timer function</i>	21
7	Voice recorder mode	22
7.1	<i>Voice recorder buttons</i>	22
8	Play Mode	23
8.1	<i>Playback mode</i>	23
8.1.1	Viewing photos	23
8.1.2	Photo playback menu	23
8.1.3	Viewing videos	24
8.1.4	Video playback menu	24
8.1.5	Listening to audio clips	24
8.1.6	Voice playback menu	25

8.2	<i>Music mode</i>	25
8.2.1	Music mode menu	25
8.3	<i>Game mode</i>	25
9	Remote control	26
10	Installing the Applications	28
10.1	<i>Drivers</i>	28
10.1.1	Camera Driver	28
Appendix	29
	<i>Specifications</i>	29

1 Introducing the Camera

Read this section to learn about the features and functions of the camera. This chapter also covers system requirements, package contents, and the camera views.

1.1 *System requirements*

The camera requires a host PC with the following specifications:

- Windows® XP, 2000, ME, 98SE operating system
- Intel® Pentium III 1 GHz CPU or higher
- At least 256 MB of RAM or higher
- Standard USB 1.1 port or higher
- 4x speed CD-ROM drive or higher
- At least 200 MB of available disk space

A USB 1.1 port will enable you to transfer files to and from the host PC, but transfer speeds will be much faster with a USB 2.0 port.
--

1.2 *Features*

The camera offers a variety of features and functions including:

- Digital Video Camera
- Digital still camera (with 8 x digital zoom, 6 Mega pixels)
- Music player
- Voice recorder
- TV/VCD/DVD recorder
- Game player

1.3 Unpacking

All the following items should be present in the camera package. If any of them is missing or appears damaged, contact your dealer immediately.



Camera

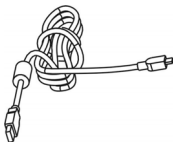

USB cable

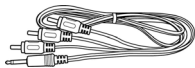

AV cable

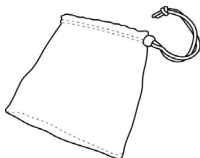

Pouch

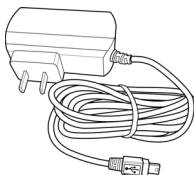

AC-in cable

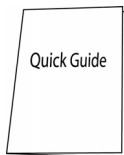

Quick Guide



Strap



CD-ROM

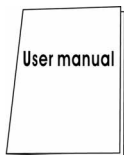

User manual

1.4 About the camera

Refer to the following diagrams to familiarize yourself with the buttons and controls of the camera.

1.4.1 Front view

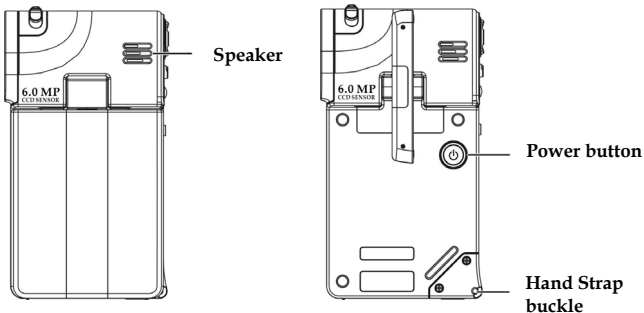

1.4.2 Right view

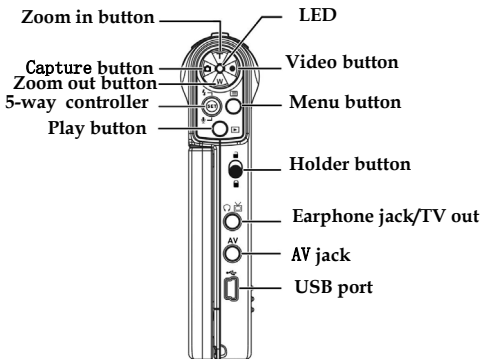

1.4.3 Left view

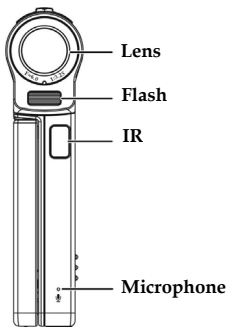

1.4.4 Top view

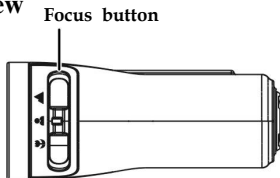



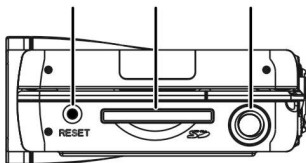

1.4.5 Bottom view



Reset button SD card
compartment Tripod nut



1.4.6 Button functions

Refer to the table below for detail function of each button:

Icon	Button	Function
	Power on / off	Turns the camera on or off.
	T (Zoom in)	1. Use to zoom in / out.
	W (Zoom out)	2. Use to adjust volume in Music and Voice play modes.
	Capture	Press to capture image
	Video	Press to start video recording
	5-way controller (left / right / up / down/ OK)	<ol style="list-style-type: none">1. Use to navigate the OSD menus.2. Press the 5-way controller left/right/up to set self-timer, White balance and Flash mode.3. Press the 5-way controller down to enter Voice recorder mode.4. Press in the 5-way controller to execute item
	Menu	Press menu button to enter/exit setting menu.
	Play	To enter a play menu (includes Playback, Music and Games play modes).

Icon	Button	Function
	Holder	When in Music play mode, use this button to deactivate all buttons.
	Focus	Push to change focus mode between Macro, Normal or Infinity.

1.4.7 Rotating the LCD monitor

Open the LCD monitor in left side of the Camera carefully.

The directions and lock position of the LCD monitor is shown as follows:

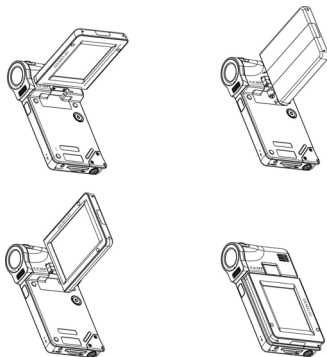

Note: Do not rotate the LCD monitor in the wrong direction to avoid damaging the LCD monitor !

2 Getting Started

Read this section to learn how to start using the camera. This section covers only basic functions.

2.1 Charging

The camera is designed to use a build-in rechargeable battery. Only simply use the USB cable in the package to connect the camera and your PC, and the charging process will be started.

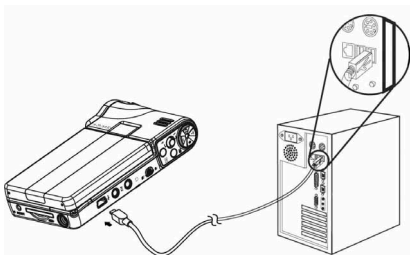

When traveling, you can also bring the AC-in power cable. By plugging the AC-in power cable into the outlet, the camera also can be charged.

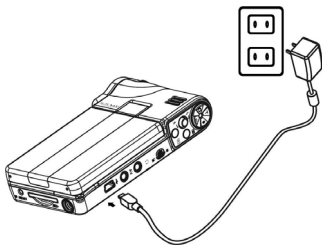

2.2 *Installing an SD card*

An SD card can be inserted into the camera to provide additional storage space.

To install an SD Card:

1. Insert the SD card in to the SD card compartment.
2. Press gently to ensure a firm connection.

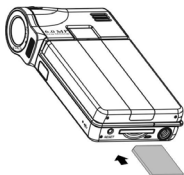

2.3 *Turning on/off the camera*

There are two ways to turn on/off the Camera:

1. Open or close the LCD monitor.
2. Press and hold the Power button.

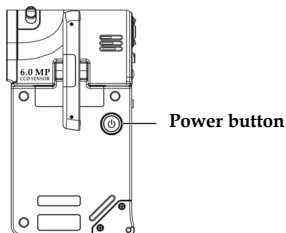

3 Using the Camera

Read this section to learn how to use the basic setup menu of this camera.

3.1 Using the LCD display

Use the LCD display to compose and review your pictures and videos stored in memory, and navigate the OSD (On Screen Display) menu.

Icons displayed on the LCD display also show the current configuration.



Video recording mode
LCD display



Preview/Capture mode
LCD display

3.2 About the LED

	LED	
	Blue	Red
Power off	OFF	OFF
Power on / Standby	ON	OFF
Processing	Flick (1HZ)	Flick (1HZ)
Battery low	OFF	Flick (1HZ)
USB connection	ON	OFF
Video recording	Flick (1HZ)	Flick (1HZ)

Capture	ON	OFF
Charging	OFF	Flick (1HZ)
Music/Voice play mode	Flick	Flick
MPEG play mode	Flick	Flick
Flash charge	OFF	Flick (1HZ)

3.3 Setup menu

The setup menu includes a number of settings to configure your camera.

To access the **Setup** menu:

1. Turn the camera on.
2. Press the **Menu** button and press the 5-way controller down to enter **Setup** menu.



To leave the Setup menu while over configuring the camera, press the **Menu** button again to leave the **Setup** menu.

3.3.1 Sound effect

Use this option to turn on or off the sound effect of the camera.



3.3.2 USB mode

Use this option when the camera was connected as a USB device.

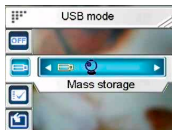

3.3.2.1 Mass storage

Press the 5-way controller left or right to select the **Mass storage**.

Connect the camera to the PC with the USB cable. Now the camera will present as a removable disk.

3.3.2.2 *PC Camera*

Connect the camera to the PC with the USB cable, and then the camera can be used as a PC camera, used in the Net-meeting or any on-line communication tools.



Note: Before connecting the camera as a PC-Camera, please install the driver on the CD-ROM first.

3.3.3 **Date and time**

Use this option to set the date and time



3.3.4 **Welcome picture**

Use this option to set a welcome screen when turning the camera on.



3.3.5 **Auto power off**

Use this option to set a period of inactivity after which the camera will switch itself off. This function can save the battery power consumption.



3.3.6 **LCD brightness**

Use this option to set the brightness of the LCD.

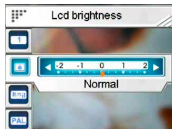

3.3.7 Language

Use the option to set a language for OSD menu of the camera.



3.3.8 TV system

Use this option to set the camera video output to match the TV system in your area.



3.3.9 Format

Use this option to format the data stored on the memory card or in the internal memory.



Note: When this function is preceded, all stored data will be erased and cannot be recovered. Make sure you backup all data before formatting.

3.3.10 Default

Use the option to reset all settings to the factory default.



3.4 Setting menu

The setting menu includes both **Video** and **Photo Modes** settings.

To access the **Setting** menu:

1. Turn the camera on.
2. Press the **Menu** button and press the 5-way controller left or right to choose between **Video Mode** and **Photo Mode**.

To leave the **Setting** menu while over configuring the camera, press the **Menu** button to leave the **Setting** menu.

3.4.1 Video mode setting

Read this section to configure the settings in Video recording mode.

To access the **Video mode**:

1. Turn the camera on and press **Menu** button.
2. Press the 5-way controller left or right to highlight the **Video Mode**.
3. Press the 5-way controller up to enter the **Video mode** setting menu.



3.4.1.1 Resolution

Use this option to set the resolution for each video shooting.



3.4.1.2 EV adjust

Use this option to change the exposure for your video. Usually this value would be set to **0.0**, but you might want to increase the exposure to light up a subject with black lighting, or decrease the exposure if taking a video in a very bright area.

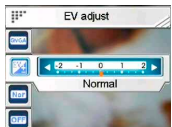

3.4.1.3 Digital filter

Use this option to convert video image to different color areas.

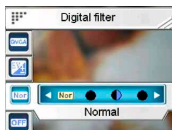

3.4.1.4 *Stabilization*

Use this option to counteract camera shake and help you to shoot clearer videos.



3.4.1.5 *Monitor Video*

Use this option to control your camera not to start shooting a video until the image within the focusing area is moving.



3.4.2 **Photo mode setting**

Read this section to configure the settings in Capture mode.

To access the **Photo mode** settings:

1. Turn the camera on and press **Menu** button.
2. Press the 5-way controller left or right to highlight the **Photo Mode**.
3. Press the 5-way controller up to enter the **Photo Mode** setting menu.

3.4.2.1 *Scene*

Use this option to select a proper scene mode to take a picture.



3.4.2.2 *Resolution*

Use this option to determine the resolution of the picture that going to be taken. A larger resolution will occupy more memory storage space.



3.4.2.3 *Image quality*

Use this option to set the image quality for the picture you're going to capture. A high quality picture occupies more memory space.



3.4.2.4 *Continuous shots*

Three pictures will be taken continuously when this function is activated. Use this function to take continuous pictures with a short delay between each.



3.4.2.5 *Couple shot*

Use this option to combine two different images in one photo.



3.4.2.6 *Date stamp*

Use this option to set the date stamp shown on the images.

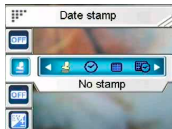

3.4.2.7 *Picture frame*

Use this option to add a picture frame to your pictures when they are taken. There are 16 picture frames to choose from.



3.4.2.8 *EV adjust*

Use this option to change the exposure for your photo. Usually this value would be set to **0.0**, but you might want to increase the



exposure to light up a subject with black lighting, or decrease the exposure if taking a video in a very bright area.

3.4.2.9 *ISO*

ISO (Sensitivity) settings control the camera's sensitivity to light. The lower sensitivity is, the higher exposure value is needed. When you increase the sensitivity, the shutter speed will be faster and exposure value will be reduced. There might be noises on the images.

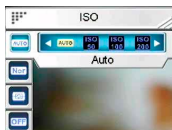

3.4.2.10 *Digital filter*

Use this option to convert image to different color areas.

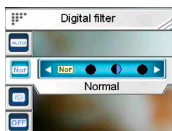

3.4.2.11 *Metering*

This camera provides 3 metering modes (**Matrix**, **Center-weighted** and **Spot**) to support you to take photos in different situations.



3.4.2.12 *Histogram*

Use this option to show a graph that displays how light is distributed in your picture.



3.4.2.13 *Icon*

Use option to turn on or off all of the icons on the LCD.

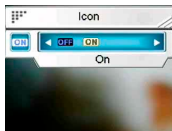







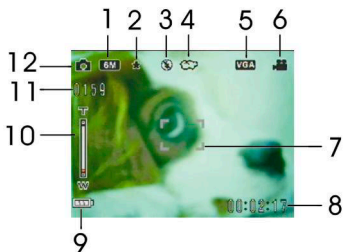



4 Preview mode

Read this section for detailed functional operating of Preview mode.

4.1 Preview mode icons



Number	Icon	Description
1		Photo r-resolution
2		Image quality
3		Flash mode
4		White balance
5		Video resolution
6		Video mode icon
7		Focus area
8		Present time

Number	Icon	Description
9		Battery indicator
10		Zoom bar
11	0159	Picture remain
12		Capture mode icon

4.2 Using the self-timer function

Use the self-timer function to set a delay between the moment you press the shutter and the moment the picture is actually captured. A delay of **3** or **10** seconds can be set. This function can be used in both capture and recorder mode.

To set the **Self-timer**:

1. Turn the camera on.
2. Press the 5-way controller left to select from **Off**, **3 sec**, or **10 sec**. The selected timer will be shown on the center of the LCD screen.
3. Press the **Capture** or **Record** button to start counting down.







4.3 Setting the Flash mode

When you start to take a picture, presses the 5-way controller up to switch between **Flash** modes.

See the table below for a detailed description and symbol of each **Flash** mode.

Note: This function will be activated only when you are taking a picture.

Icon	Description
	Flash is turned off.
	Auto flash, fires only when needed.
	Force flash, flash is always on.
	Slow sync flash

4.4 *White balance*

Use this option to correct color for different lighting conditions.

Turn on the camera and the press the 5-way controller right to select from **Auto**, **Daylight**, **Cloudy**, **Tungsten**, or **Fluorescent**. (Each press will just change the mode once)

4.5 *Using the zoom function*

This function works in both Capture and Video modes.

To control the zoom function press the **T (Zoom in)** button which getting closer to the subject, or **W (Zoom out)** button which moving away from the subject.

The zoom bar on the LCD screen indicates the zoom status.

5 Shooting your first video

Before shooting your first video, ensure you have read “**1 Introducing the Camera**”, “**2 Getting Started**”, and “**3 Using the Camera**” carefully.

To shoot a video:

1. Turn on the camera.
2. Use the **focus area** on the LCD screen to frame the subject.
3. Press the **Video** button to shoot the video.

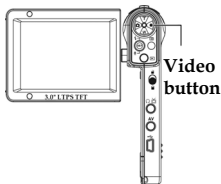

The video clip will be saved either on the SD card or in the internal memory with a unique file name.

5.1 *DV mode settings*

Please refer to “**3.4.1 Video mode**” for detailed information.

5.2 *Using the zoom function*

Please refer to “**4.5 Using the zoom function**” for detailed information.

5.3 *Using the self-timer function*

Please refer to “**4.2 Using the self-timer function**” for detailed information.

6 Taking your first picture

Before shooting your first picture, ensure you have read “**1 Introducing the Camera**”, “**2 Getting Started**”, and “**3 Using the Camera**” carefully.

To take a picture:

1. Turn on the camera.
2. Use the **focus area** on the LCD screen to frame the picture.
3. Press the **Capture** button to capture the picture.

Capture button

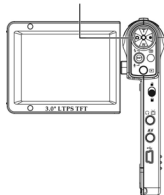

The picture will be saved either on the SD card or in the internal memory with a unique file name.

6.1 *Photo mode settings*

Please refer to “**3.4.2 Photo mode**” for detailed information.

6.2 *Using the zoom function*

Please refer to “**4.5 Using the zoom function**” for detailed information.

6.3 *Setting the Flash mode*

Please refer to “**4.3 Setting the Flash mode**” for detailed information.

6.4 *Using the self-timer function*

Please refer to “**4.2 Using the self-timer function**” for detailed information.

7 Voice recorder mode

Read this section and learn how to operate the camera as a voice recorder. Turn on the camera, and press the 5-way controller down to enter the **Voice recorder** mode.

7.1 Voice recorder buttons

Refer to the table below for button function

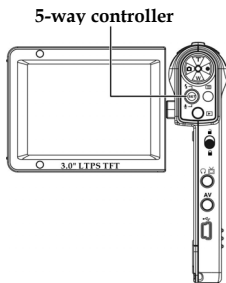

Icon	Button	Function
	5-way controller	Press in the 5-way controller to start/stop recording.

8 Play Mode

Read this section for detailed information of Play mode.

Turn on the camera, and press the **Play** button to enter Play mode. This mode includes **Playback**, **Music** and **Game** modes.

8.1 Playback mode

After entering the Playback mode, the photos, videos and voices saved either on the SD card or in the internal memory, will be shown in order.

To enter **Playback** mode:

1. Press the 5-way controller left or right in **Play** mode and highlights the **Playback** option.
2. Press in the 5-way controller to confirm.

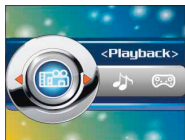

Press the 5-way controller left or right to show next or previous file.

8.1.1 Viewing photos

When viewing an image:

1. Press the **T** or **W** button to zoom in or out the photo.
2. Press the 5-way controller down to record a 20s voice memo.
3. Press **Play** button again to return to Play menu.

8.1.2 Photo playback menu

While viewing the images, press the **Menu** button to configure the photo playback settings.

Use the 5-way controller up or down to choose an option.

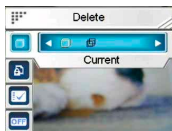

Note: This function will be activated only when there is at least one image file in the SD card or the internal memory.

8.1.3 Viewing videos

When browsing a video file, the first frame of the whole video will be shown on the screen.

To view a video:

1. Press in the 5-way controller to start playing, and press it again to stop.
2. Press the 5-way controller left or right to play fast backward (2X, 4X, 8X, 10X) or fast forward (2X, 4X, 8X, 10X) when you are playing a video. Each press will change a playing speed.
3. Press the **T** or **W** button to adjust the volume.

Note: You must stop playing the file, then you can view next or previous file.

8.1.4 Video playback menu

While viewing the video in **Playback** mode, press the **Menu** button to configure the video playback settings.

Use the 5-way controller up or down to choose an option.



Note: This function will be activated only when there is at least one video file in the SD card or the internal memory.

8.1.5 Listening to audio clips

To play a voice file:

1. Press in the 5-way controller to play or pause the current file.
2. Press the 5-way controller down to stop playing.
3. Press the **T** or **W** button to adjust the volume.

Note: You must stop playing the current file, and then you can view next or previous file.

8.1.6 Voice playback menu

When the voice file is in **whole screen** mode, press the **Menu** button to configure the voice playback settings.

Note: This function will be activated only when there is at least one voice file in the SD card or the internal memory.

8.2 Music mode

1. Turn on the camera, and press the Play button to enter **Play** mode.
2. Press the 5-way controller left or right to highlight the **Music** option.
3. Press in the 5-way controller to confirm.

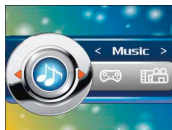

8.2.1 Music mode menu

In the file list mode, press the **Menu** button and configure the Music settings.

Note: This function will be activated only when there is at least one Music file in the SD card or the internal memory.

8.3 Game mode

1. Turn on the camera, and press the **Play** button to enter Play mode.
2. Press the 5-way controller left or right to highlight the **Game** option.
3. Press in the 5-way controller to confirm.



Press the 5-way controller left or right to select a game from **Sudoku**, **Tetris**, **Moving box** or **Lotto**.

9 Remote control

This camera provides IR remote control function.

Refer to the table below for button function:

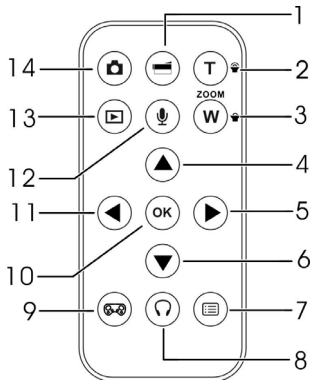

Number	Description
1	Use to start/stop video recording.
2	1. Use to zoom in / out.
3	2. Use to adjust volume in Music and Voice play modes.
4	1. Use to navigate the OSD menus. 2. Use to set Flash mode.
5	1. Use to navigate the OSD menus. 2. Use to set White balance

6	1. Use to navigate the OSD menus. 2. Use to enter voice recorder mode.
7	Use to enter/exit setting menu.
8	Use to enter/exit Music mode.
9	Use to enter/exit Game mode.
10	Use to execute item.
11	Use to set self-timer.
12	Use to enter voice recorder mode.
13	Use to enter play mode.
14	Use to capture image.

10 Installing the Applications

10.1 Drivers

After installing the camera driver, you can use the camera as a “**Mass Storage device**” on the PC.

10.1.1 Camera Driver

The camera offers Mass Storage function as a card reader device.

When the driver has been installed and the camera is connected, the camera memory and any installed mini SD card will appear as **Mass Storage Device** in Windows Explorer. Files can be dragged and dropped in the same way as on an ordinary disk.

Before connecting the camera to the PC as a **PC camera**, please also following the instruction to finish the driver installation.

Please follow the instructions below:

1. Insert the supplied CD-ROM in the CD-ROM drive.
2. Use Windows Explorer to execute the **Setup.exe** file in the root directory.
3. The installation is configuring the window settings.

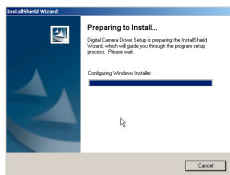

Appendix

Specifications

General	
CMOS Sensor Format	1/ 2.5-inch
DSP	COACH 8m
Resolution (Image)	4032x3024 3648x2736 2816x2212 2048x1536 1600x1200 1280 x 960 640x480
Resolution (Video)	320x240 640x480
Physical Size	63 (W) x 119 (H) x 23 (D)
Video Clips	30 fps @QVGA, 30 fps @VGA, 30 fps @D1
Audio	Microphone, Speaker
DC-in	N/A
Image LCD	3.0" TFT LCD

General	
Battery	1300 mAH internal Li-Polymer
Interfaces	USB 2.0 high speed
Internal memory	32 MB NAND
Removable memory card	Removable Secure Digital (SD) memory card
Case material	Plastic
AC Adapter	Yes
TV out	Video / Audio output (Stereo)
TV in	Video / Audio input (Stereo)
Audio out	Music
Boot-up time	<= 2 Secs, start from pressing the Power button/open the LCD plate
Shot to shot time	<= 4.5 Secs
Flash	Flash off/Auto Flash/Force flash/Slow sync flash
Zoom	8X digital zoom
Focus distance	People:70~200cm; Mountain:200cm~infinity, Macro: 20cm