

Digital Video Camera

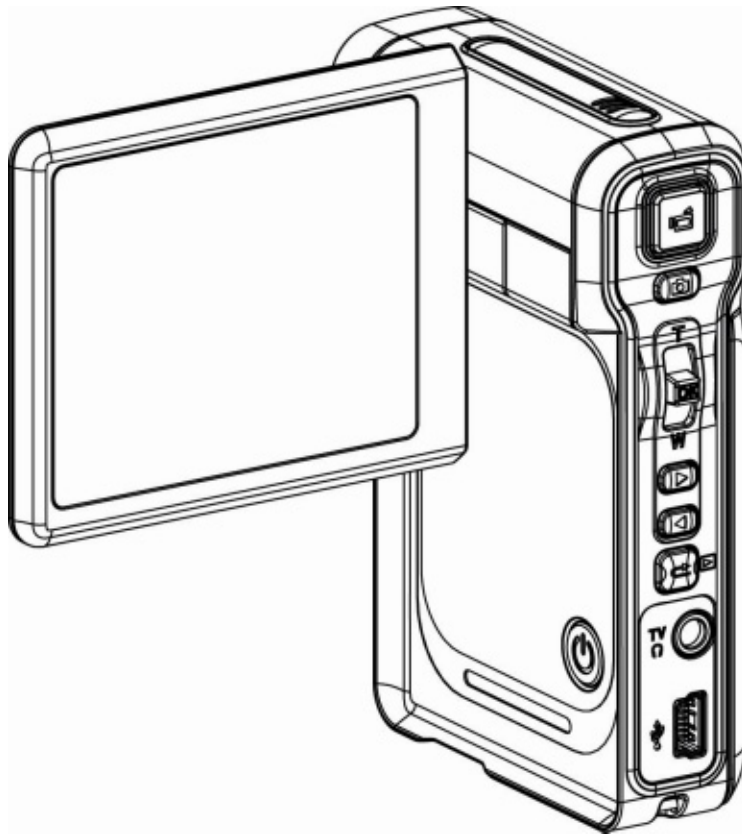

User Manual

Contents

Content.....	1
Section 1 Getting to Know Your Camera.....	2
Section 2 Getting Up and Running	5
Section 3 Record Mode.....	7
Section 4 Playback Mode	35
Section 5 Listening to MP3 Music	49
Section 6 Reading eBook	51
Section 7 Viewing MPEG4 Movie on PC.....	53
Section 8 Viewing Pictures and Movies on a TV	54
Section 9 Video File Converter.....	55
Section 10 Burning the Recorded Clip into DVD.....	63
Section 11 Transferring Data to a Computer.....	65
Section 12 Specifications and System Requirements	67

Getting to Know Your Camera

◆ Overview

The camera with 5.2 Mega Pixel sensor can take DVD-Quality MPEG-4 movies. By way of using MPEG-4 technology, more videos can be taken within certain amount of memory. High quality images with up to 11 mega-pixels can also be delivered smoothly. With a color LCD monitor, users can compose images and examine them easily.

Exposure and color balance can either be adjusted automatically or allowed to be changed manually. An 8x digital zoom increases user control over the movies and pictures you take. The camera is also ideally suited for using as a PC camera hooked up to your home computer via high speed USB 2.0 port

Build-in 64 MB memory allows you to take pictures and movies without memory card. The memory card slot allows users to increase the storage capacity up to 4GB.



Note

Partial memory of the built-in 64MB memory is used for Firmware code

◆ Standard Accessories

Unpack the package and make sure all standard accessories listed are included:

- Camera
- USB Cable
- AV Cable
- AA Battery
- Quick Guide
- CD-ROM (Driver, Arcsoft Software and User Manual)
- Earphone
- Strap
- Pouch

◆ Front View

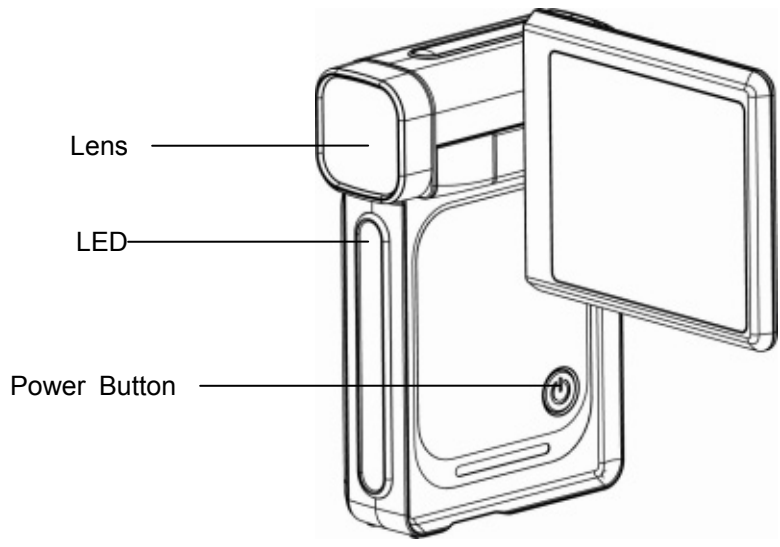

◆ KeyPad illustration

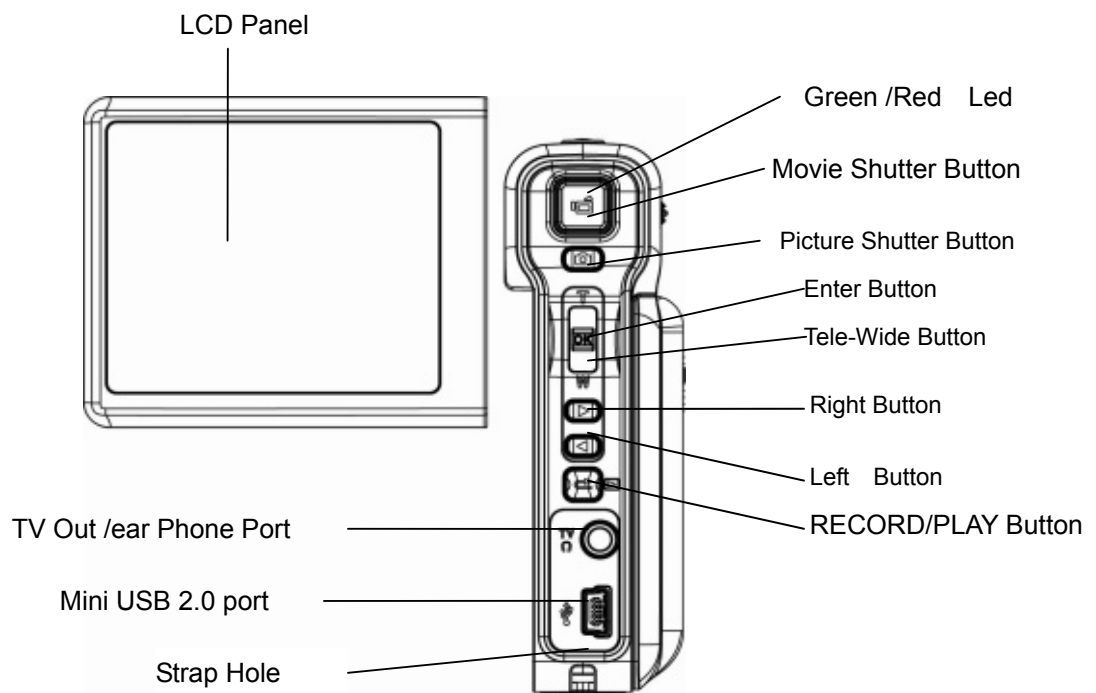

◆ Side View

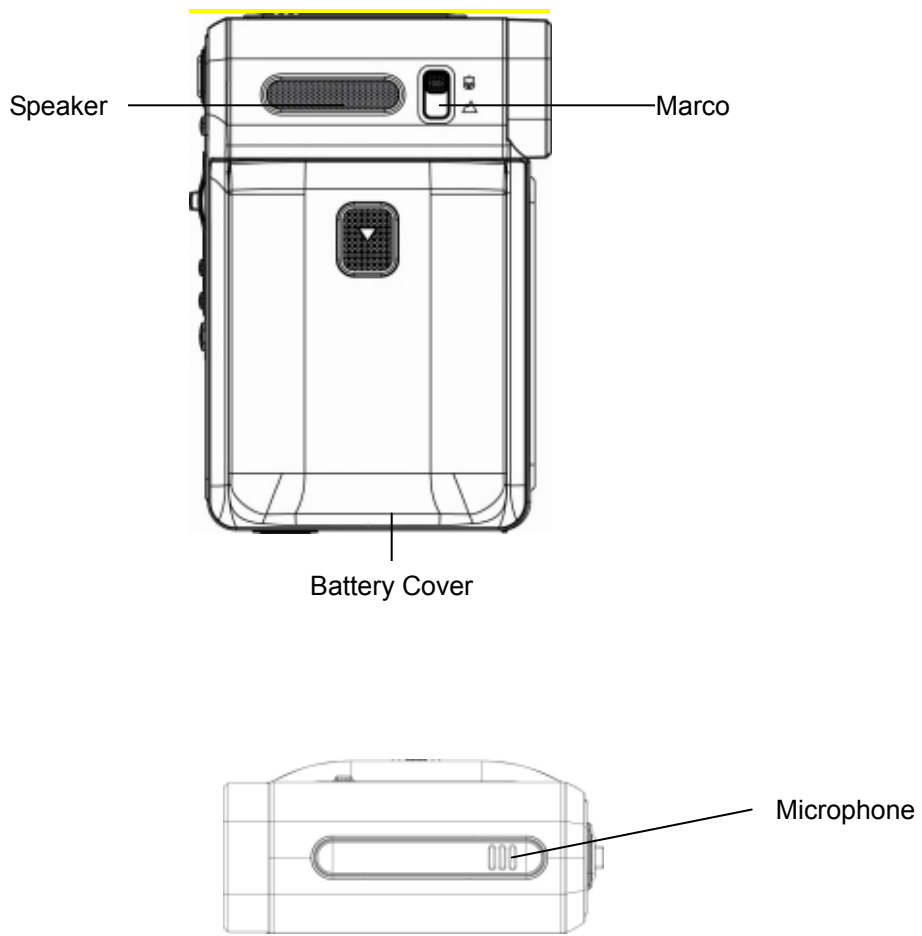

Section 2

Getting Up and Running

◆ Loading the Battery

Before using the camera, end users must load NP60 rechargeable Li-ion Battery.

1. Follow the arrow direction and slide to eject the battery cover.
2. Insert the batteries according to the correct polarity marks (+ or -)
3. Close the battery cover firmly.

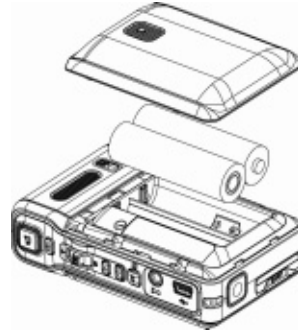

◆ Inserting and Removing an SD Card (Optional)

The camera comes with internal memory which allows you to store pictures, movies, voice recordings and music. You can expand the memory capacity by using an optional SD or MMC memory card up to 4GB. To insert a memory card, refer to the figure as below:

1. Insert the memory card into the right position.
2. To remove an installed SD card, press the card inwards to release it.
3. When the card pops out, gently remove it from its slot.

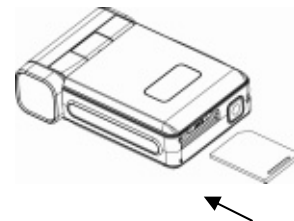

Note

When a memory card is fitted, movies and pictures are saved on card rather than on the built-in memory.

◆ Protecting Data on an SD Card

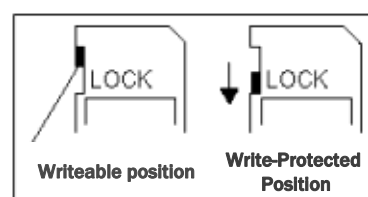

SD card is read-only by locking the SD card. No pictures, movies and voice can be recorded when the SD card is locked. Make sure the lock is on writeable position before recording any media.



◆ Turning the Camera On and Getting Started

To turn on the camera:

- (1) Flip out the LCD panel; the camera will turn on automatically.
- (2) Or press Power Button for one second to turn on it.

- ⇒ To take a movie, press the Movie Shutter Button ()
- ⇒ To take a picture, press the Picture Shutter Button ()
- ⇒ To record the voice, press the enter key and press Right/Left Button to voice pen for voice recording.
- ⇒ To view stored movies, pictures, listen to voice recordings, press RECORD/PLAY Button once to switch to Playback Mode. Press a second time to return to Record Mode.





◆ Turning the Camera Off

To turn off the Camera, you can either press the Power Button for one second, or you can place the LCD panel back to its original position.

Section 3

Record Mode

◆ Button Function

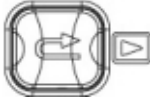
	Power Button: Press down for one second to turn on or turn off the camera.
	Movie Shutter Button: 1. Start to take movie, or record voice. 2. To stop recording, press it again.
	Picture Shutter Button: Take the picture
	Tele-Wide Button: Digital Zoom in and out. OK Button : Menu ON
	Right Button : Flash ON/OFF/Red-Eye Reduction/Light ON/Auto Left Button : Self-Timer ON/OFF
	RECORD/PLAY Button: 1. Switch between Record /Playback Mode. 2. Return to the previous page.

◆ LCD Monitor Information



The indicator shows below may display on LCD when movies and pictures are recorded



(1)	Record Mode
	Movie Record Mode
	Picture Record Mode
	Voice Record Mode
	Motion Stabilization
	Photo Frame
	Multi-Snap Mode
	Night Mode
	Backlight Mode
(2)	Resolution
	Movie ★★High / ★★Standard / ★ Low Picture: ★★High / ★★Standard / ★ Low
(3)	Number of images or recording time of movie that can still be taken at current resolution.
(4)	SD card inserted
(5)	Macro Position Focusing
(6)	WB Manual White Balance
(7)	Battery indicator : full power / medium power / low power / power empty
(8)	Flash On
	Flash Off
	Red Eye Reduction
	Light on
	Auto
(9)	Self-timer enabled
(10)	8X digital zoom

(11)	Date/Time : YYYY/MM/DD
(12)	 Motion Detection (Enable)

◆ MPEG4 Movie Recording

Press Movie Shutter button () to start recording. When a movie is recording, a time indicator will display on LCD monitor. To stop recording, press Movie Shutter Button () again. Press RECORD/PLAY Button to view the recorded movie. Three resolution settings are available:

Quality
High Quality ★★★
Standard Quality★★
Low Quality ★

◆ Picture Recording

Press the Picture Shutter Button () to take a picture.

Press RECORD/PLAY Button to view the picture.

Three resolution settings are available:

Image Quality
High Quality ★★★
Standard Quality★★
Low Quality ★

◆ Using Digital Zoom



The digital zoom magnifies images, when recording movies or taking pictures.

1. To zoom in/out, press the Tele/Wide Button.
2. The digital zoom can be set from 1x to 8x and the magnification ratio is shown on the LCD monitor.

◆ Options for Record Mode

Movie Mode	Picture Mode	Voice Pen	Effect	Set
<ul style="list-style-type: none"> • Resolution • Exposure • Light • Sharpness • White Balance • Stabilization • Motion Detect • Night mode • Exit 	<ul style="list-style-type: none"> • Resolution • Exposure • Two in One • Photo Frame • Flash • Self-timer • Sharpness • White Balance • Multi-snap • Backlight • Date printing • Night mode • Exit 	<ul style="list-style-type: none"> • Enter • Exit 	<ul style="list-style-type: none"> • Normal • B/W • Classic • Negative • Exit 	<ul style="list-style-type: none"> • Sound • Start-up Screen • Time Setting • Format Memory • TV System • Language • Default Setting • Exit

◆ Operations for Record Mode

Operation	Screen
1. Press Enter Button when in Movie/Picture Record Mode.	
2. Use Right/Left Buttons to move between main menu options, which are Movie Mode, Camera Mode, Voice Mode, Effect, and Set. Submenu will pop out while move to each main option.	<p>↓ Enter Button</p> 
3. Press OK Button to validate sub option you select.	
4. Select Exit option to exit submenu.	

◆ Default Setting and Validation

The following table indicates the camera's default setting as well as its validation.

1. Always: The setting always keeps valid.
2. One Time: The setting is only valid either once or till camera power off.

	Validation	Default Factory Setting
Resolution	Always	High for Movie Standard for Picture
Exposure	One Time	0EV
Sharpness	One Time	Level 5
White Balance	One Time	Auto
Motion Stabilization	Always	Off
Motion Detect	One Time	Off
Two in One	One Time	Off
Photo Frame	One Time	Off
Flash	Always	Off
Self-Timer	One Time	Off
Multi-Snap	One Time	Off
Backlight Mode	One Time	Off
Date Printing	Always	Off
Effect	One Time	Normal
Sound	Always	On
Format Card	One Time	Off
TV System	Always	Depends on shipping area
Language	Always	Depends on shipping area
Volume	Always	Level 6

◆ **Movie Mode submenu Setting**

Record main menu includes camera setting and other advanced setting. You can use Right/Left Buttons to move between options and press Enter Button to validate the setting.

◆ **Movie Resolution**

To change Movie Resolution:

1. In Movie/Picture Record Mode, press Enter Button to switch to record menu screen.
2. Use Right/Left Buttons to select Movie Mode. Submenu of Movie Mode will pop out on the screen.
3. Use T/W key to select Resolution then press Enter Button to switch to Resolution submenu.
4. Use T/W key Buttons to move between three settings.
5. Press Enter Button to validate the setting and exit.

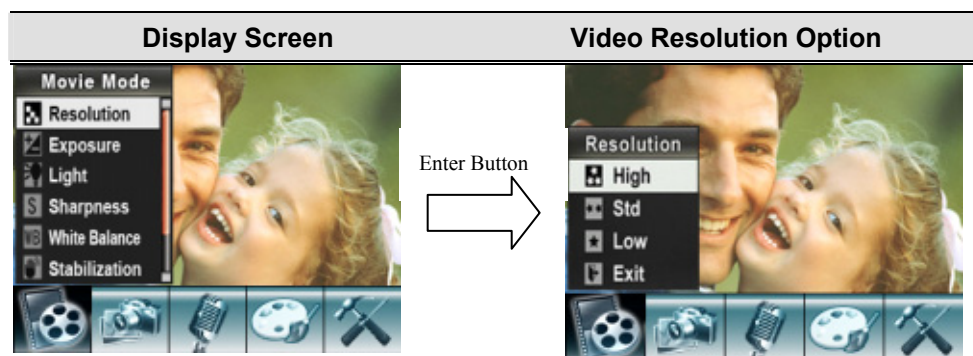

◆ Exposure

The camera adjusts image exposure automatically. In certain circumstances you may wish to adjust the exposure compensation setting.

To change Exposure setting:

1. In Movie/Picture Record Mode, press Enter Button to switch to record menu screen.
2. Use Right/Left Buttons to select Movie Mode. Submenu of Movie Mode will pop out on the screen.
3. Use T/W key Buttons to move to Exposure Option. Press the Enter Button and then Exposure Submenu will pop out on the screen.
4. Use T/W key Buttons to choose preferred EV value. The change can be previewed immediately.
5. Press Enter Button to validate the setting and exit.

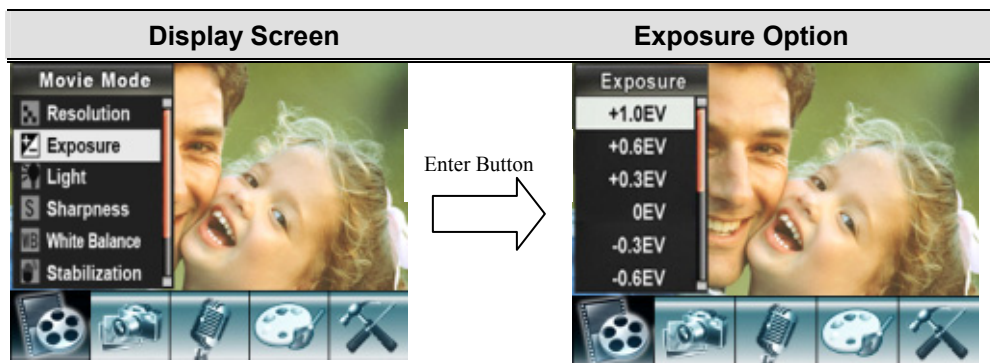

◆ Light

There are 2 flash settings under Movie Mode. To change flash settings, press the hot key (Right Button) or select from the option menu.

🔆 **On:** The LED will be turned on and keeps providing light in the low light environment

🔆 **Off:** The LED is turned off

To change Flash setting:

1. When in Movie Mode, use Up/Down Buttons to select Flash Option, then press Enter Button to switch to Flash submenu.
2. Use Up/Down Buttons to move between 2 settings.
3. Press Enter Button to validate the setting and exit.



Note

- The flash will be disabled automatically when battery power is low (🔋)

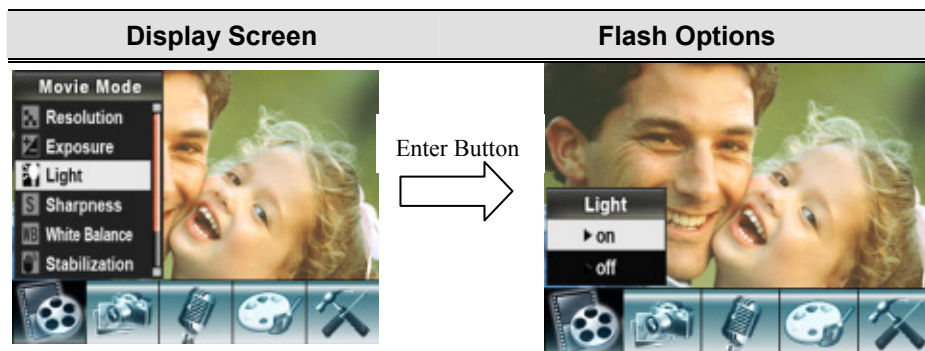

◆ Sharpness

You can soften and sharpen images to achieve different effects.

To change Sharpness setting:

1. In Movie/Picture Record Mode, press Enter Button to switch to record menu screen.
2. Use Right/Left Buttons to select Movie Mode. Submenu of Movie Mode will pop out on the screen.
3. Use T/W key to select Sharpness then press Enter Button to switch to Sharpness submenu.
4. Use T/W key to move between nine levels. The change can be previewed immediately.
5. Press Enter Button to validate the setting and exit.

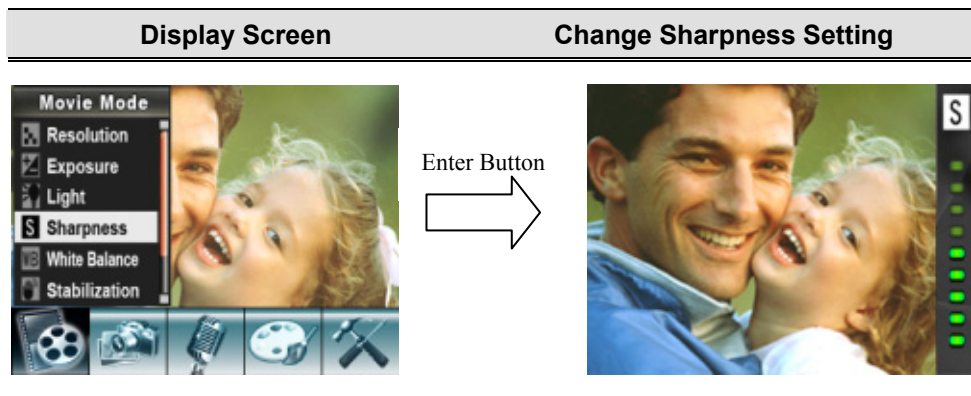

◆ White Balance

The camera adjusts the color balance of images automatically. Three manual white balance settings are available:

1. Auto (Default): The camera automatically adjusts white balance.
2. Daylight: Under outdoors
3. Fluorescent: Under fluorescent light condition.
4. Tungsten: Under tungsten light condition.

To change White Balance Setting:

1. In Movie/Picture Record Mode, press Enter Button to switch to record menu screen.
2. Use Right/Left Buttons to select Movie Mode. Submenu of Movie Mode will pop out on the screen.
3. Use T/W key to select White Balance, then press Enter Button to switch to White Balance submenu.
4. Use T/W key to move between four settings. The change can be previewed immediately.
5. Press Enter Button to validate the setting and exit.

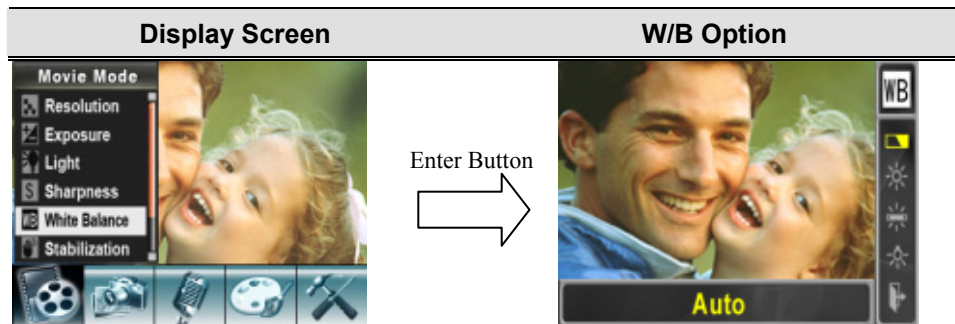

◆ Stabilization

To enable Stabilization:

1. In Movie/Picture Record Mode, press Enter Button to switch to record menu screen.
2. Use Right/Left Buttons to select Movie Mode. Submenu of Movie Mode will pop out on the screen.
3. Use Up/Down Buttons to select Motion Stabilization then press Enter Button to switch to Motion Stabilization submenu.
4. Use Up/Down Buttons to choose ON or OFF.
5. Press Enter Button to validate the setting and exit.

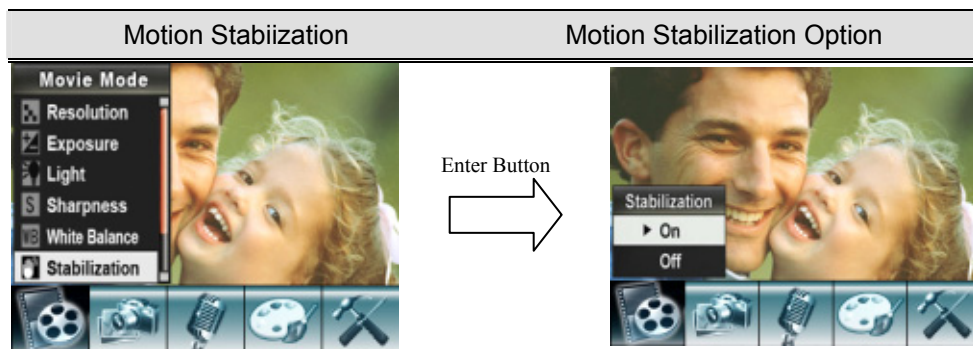

◆ Motion Detection

To enable Motion Detection:

1. In Movie/Picture Record Mode, press Enter Button to switch to record menu screen.
2. Use Right/Left Buttons to select Movie Mode. Submenu of Movie Mode will pop out on the screen.
3. Use T/W key to select Motion Detect then press Enter Buttons to switch to Motion Detect submenu.
4. Use T/W key to choose ON or OFF.
5. Press Enter Button to validate the setting and exit.
6. Camera will start to record video once if there is a movement for 3 consecutive seconds. Stop recording if there is no movement for 3 seconds.

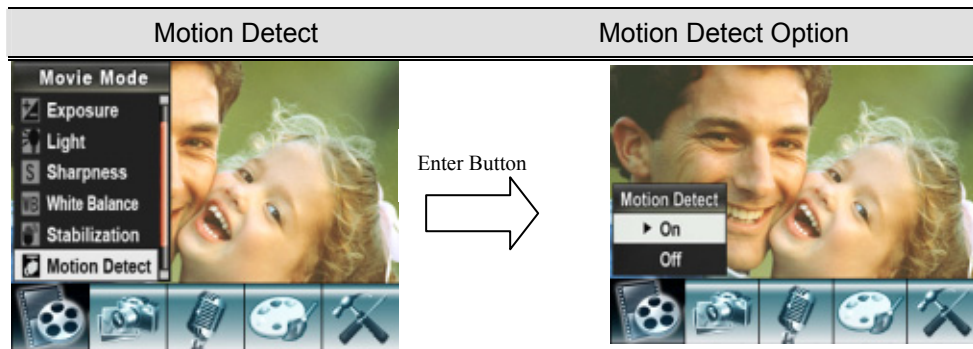

◆ Night Mode

Use Night Mode for night scenes or low light conditions. A longer exposure captures more detail of background subjects.

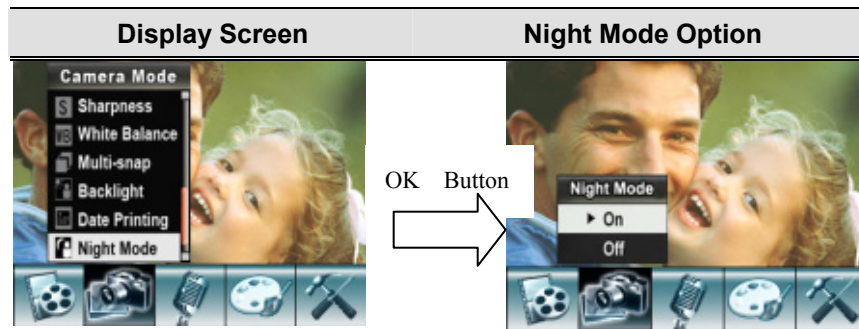

Note

To avoid blurry pictures, place the camera on a flat, steady surface, or use a tripod.

◆ Camera Mode Setting

◆ Picture Resolution

To change Picture Resolution:

1. In Movie/Picture Record Mode, press Enter Button to switch to record menu screen.
2. Use Right/Left Buttons to select Camera Mode. Submenu of Camera Mode will pop out on the screen.
3. Use T/W key to select Resolution then press Enter Button to switch to Resolution submenu.
4. Use T/W key to move between three settings.
5. Press Enter Button to validate the setting and exit.

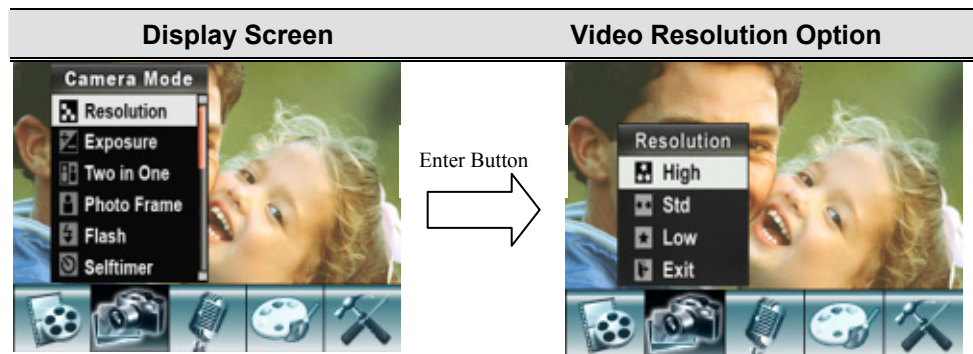

◆ Exposure

The camera adjusts image exposure automatically. In certain circumstances you may wish to adjust the exposure compensation setting.

To change Exposure setting:

1. In Movie/Picture Record Mode, press Enter Button to switch to record menu screen.
2. Use Right/Left Buttons to select Camera Mode. Submenu of Camera Mode will pop out on the screen
3. Use T/W key to move to Exposure Option. Press the Enter Button and then Exposure Submenu will pop out on the screen.
4. Use T/W key to choose preferred EV value. The change can be previewed immediately.
5. Press Enter Button to validate the setting and exit.

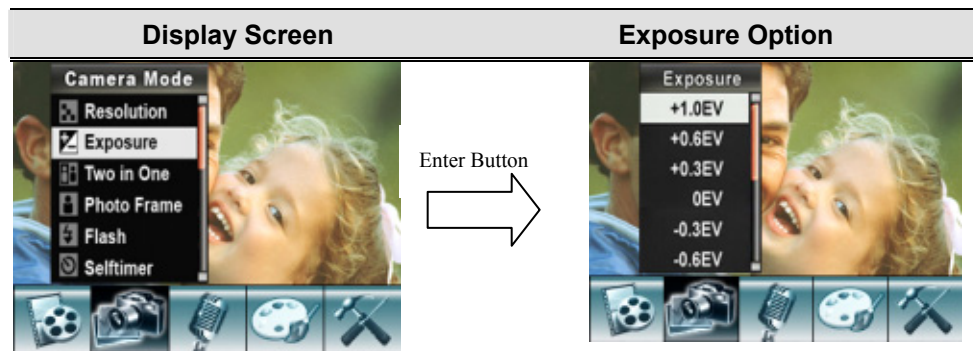

◆ Two in One (Picture Record Mode Only)

With camera set to Two in One mode, you can combine two snapshots into one picture. To enable Two in One:

1. In Movie/Picture Record Mode, press Enter Button to switch to record menu screen.
2. Use Right/Left Buttons to select Camera Mode. Submenu of Camera Mode will pop out on the screen.
3. Use Up/Down Buttons to select Two in One then press Enter Button to switch to Two in One submenu.
4. Use Up/Down Buttons to choose ON or OFF.
5. Press Enter Button to validate the setting and exit.

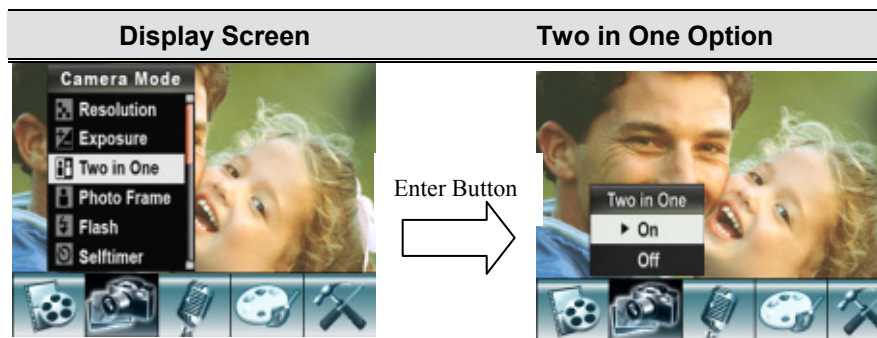

1. Press Picture Shutter Button to take first picture.



2. Press Picture Shutter Button to take second picture.



3. Press the RECORD/PLAY Button to view the Two in One picture.



◆ **Photo Frame (Picture Record Mode Only)**

Your camera features popular electronic photo frame. You can take your picture with preferred electronic photo frame. To enable Photo Frame:

1. When in Camera Mode, use T/W key to select Photo Frame option, then press Enter Button to switch to Photo Frame submenu.
2. Use T/W key to locate preferred photo frame. Then select Set option and press Enter Button to validate the setting and exit.

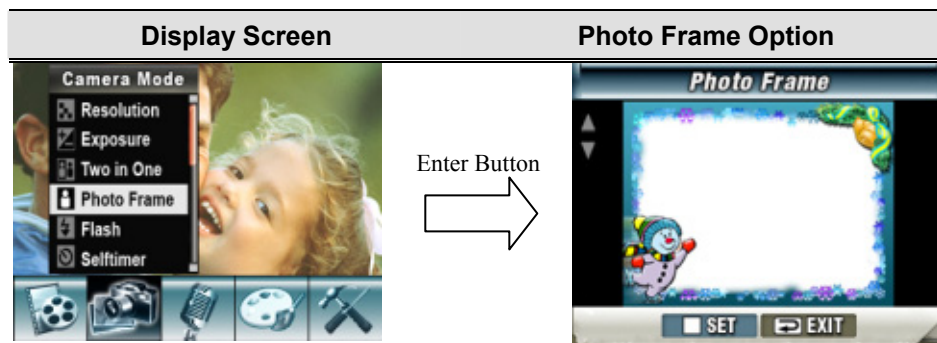



◆ Flash

There are four flash settings under Camera Mode. To change flash settings, press the hot key (Right Button) or select from the option menu.

⊗ **Auto Flash**(): The flash fires automatically according to light conditions. Use this mode for general photography.

⊗ **Flash On**(): The flash will fire in every shot.

⊗ **Flash Off**(): The flash will not fire under any circumstances. Use this mode when taking images in a place where flash photography is prohibited, or when the subject is distant (beyond the range of the flash).

⊗ **Red-Eye Reduction**(): The flash fires twice before the picture is taken

To change Flash setting:

1. When in Camera Mode, use T/W key to select Flash Option, then press Enter Button to switch to Flash submenu.
2. Use T/W key to select setting.
3. Press Enter Button to validate the setting and exit.



Note

- The flash will be disabled automatically when battery power is low ()

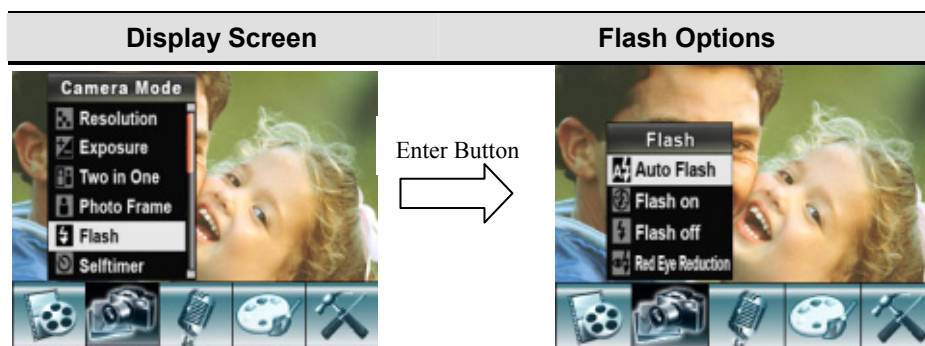

◆ Self-timer (Picture Record Mode Only)

The self-timer allows you to take pictures with a ten-second time delay. To activate Self-timer by either hot key (Left Button) or Option Setting. The self-timer LED on the front of the camera beneath the flash light will also blink. The speed of blinking will increase just before the picture is taken.

To enable Self-timer:

1. When in Camera Mode, use T/W key to select Self-timer, then press Enter Button to switch to Self-timer submenu.
2. Use T/W key to choose On or Off.
3. Press Enter Button to validate the setting and exit.

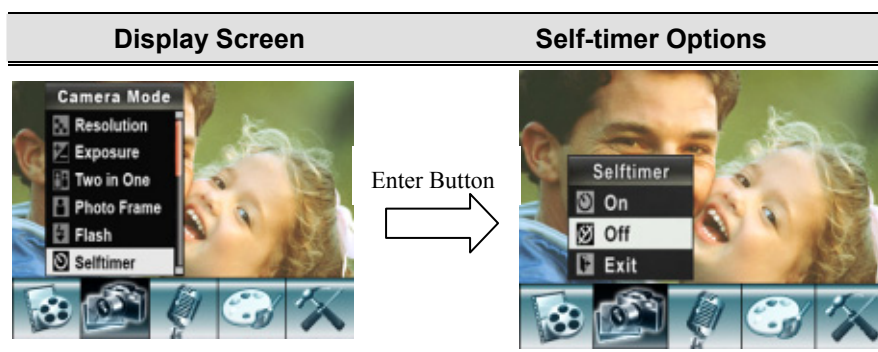

◆ Sharpness

You can soften and sharpen images to achieve different effects.

To change Sharpness setting:

1. When in Camera Mode, use T/W key to select Sharpness Option, then press Enter Button to switch to Sharpness submenu.
2. Use T/W key to select Sharpness then press Enter Button to switch to Sharpness submenu.
3. Use T/W key to move between nine levels. The change can be previewed immediately.
4. Press Enter Button to validate the setting and exit.

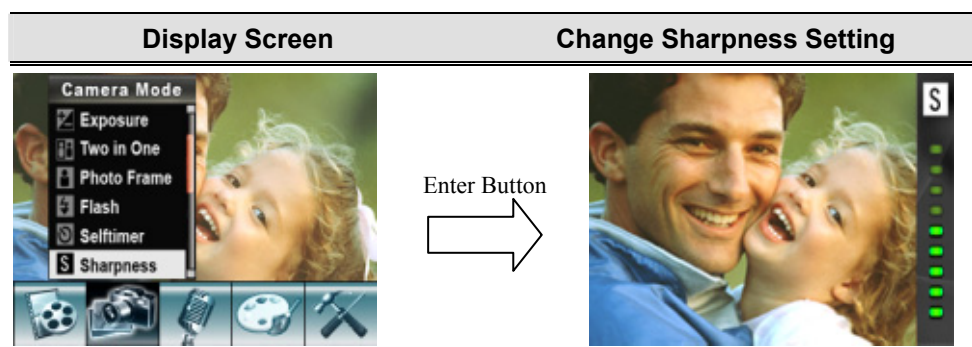

◆ White Balance

The camera adjusts the color balance of images automatically. Three manual white balance settings are available:

1. Auto (Default): The camera automatically adjusts white balance.
2. Daylight: Under outdoors
3. Fluorescent: Under fluorescent light condition.
4. Tungsten: Under tungsten light condition.

To change White Balance Setting:

1. In Movie/Picture Record Mode, press Enter Button to switch to record menu screen.
2. Use Right/Left Buttons to select Camera Mode. Submenu of Camera Mode will pop out on the screen.
3. Use T/W key to select White Balance, then press Enter Button to switch to White Balance submenu.
4. Use T/W key to move between four settings. The change can be previewed immediately.
5. Press Enter Button to validate the setting and exit.

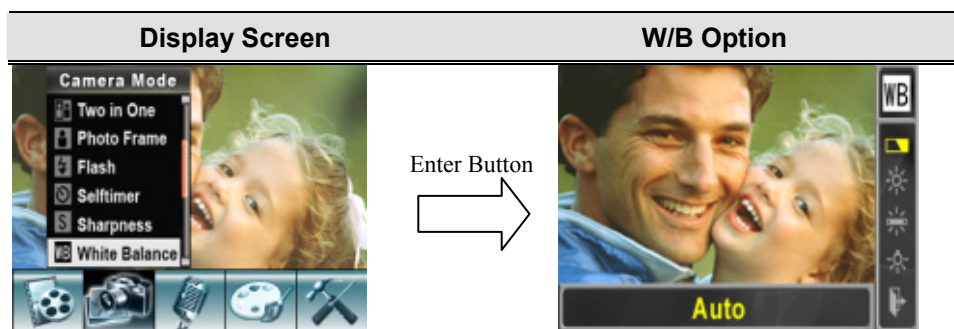

◆ Multi-Snap

With the camera set to Multi-Snap Mode, you can take five continuous pictures.

To enable Multi-Snap:

1. When in Camera Mode, use T/W key to select Multi-Snap, then press Enter Button to switch to Multi-Snap submenu.
2. Use T/W key to choose On or Off.
3. Press Enter Button to validate the setting and exit.

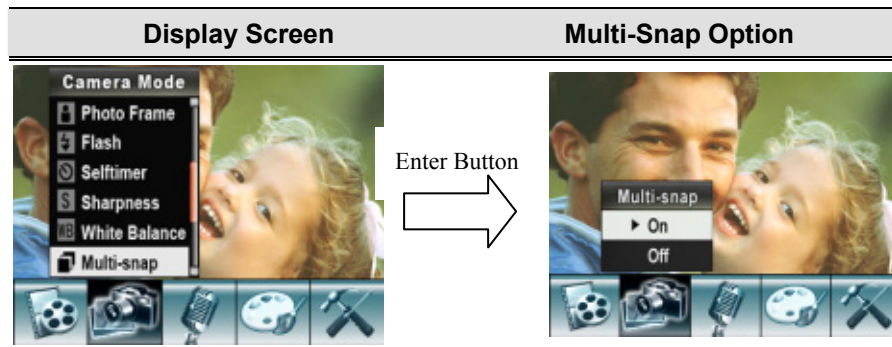

◆ Backlight

With the camera set to backlight Mode, you can take shots when bright light is behind the subject.

To enable Backlight:

1. When in Camera Mode, use T/W key to select Backlight, then press Enter Buttons to switch to Backlight submenu.
2. Use T/W key to choose On or Off.
3. Press Enter Button to validate the setting and exit.

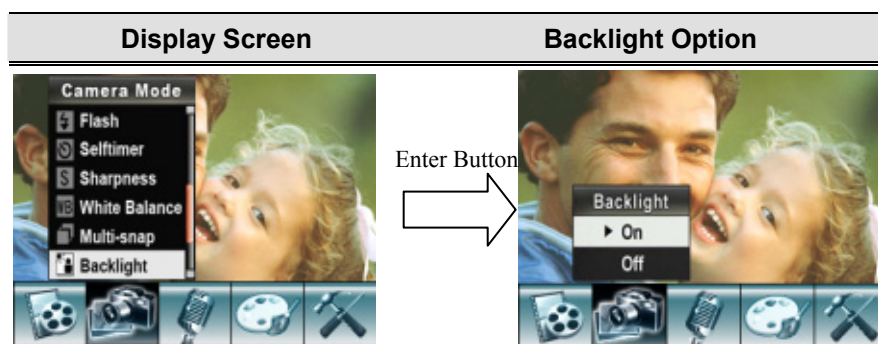

◆ Date Printing

To enable Date Printing:

1. When in Camera Mode, use T/W key to select Date Printing, then press Enter Buttons to switch to Date Printing submenu.
2. Use T/W key to choose On or Off.
3. Press Enter Button to validate the setting and exit.

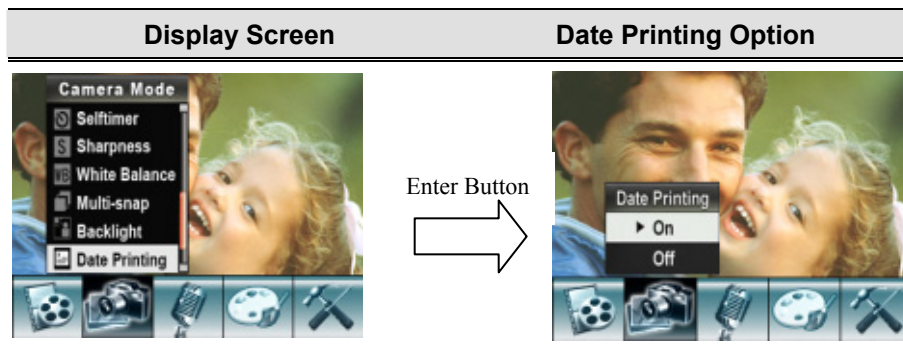

Note

Date would be shown on the printed picture once date printing is enabled.

◆ Night Mode

Use Night Mode for night scenes or low light conditions. A longer exposure captures more detail of background subjects.



Note

To avoid blurry pictures, place the camera on a flat, steady surface, or use a tripod.

◆ Voice Mode

To enable voice recording:

1. In Movie/Picture Record Mode, press Enter Button to switch to record menu screen.
2. Use Right/Left Buttons to move to Voice Option. Then Voice Submenu will pop out on the screen.
3. Use Up/Down Button to move between Enter and Exit Option.
4. Choose Enter option to enable voice recording and press Enter Button to validate the setting and exit.

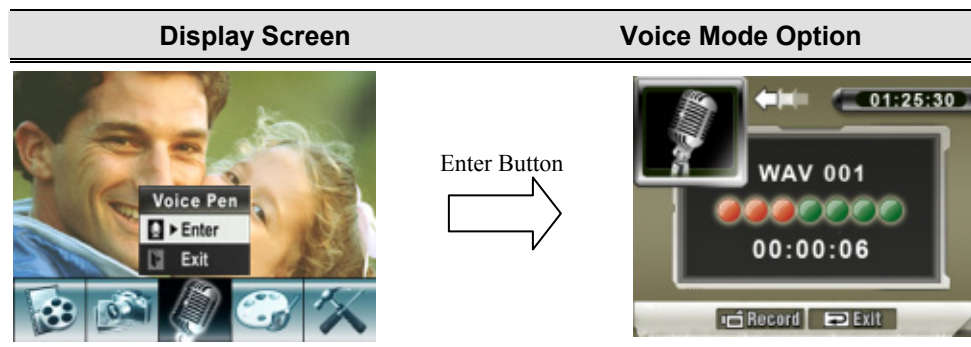

◆ Effect Setting

There are four modes which are Normal, Black/White, Classic and Negative.

To change Effect setting:

1. In Movie/Picture Record Mode, press Enter Button to switch to record menu screen.
2. Use Right/Left Buttons to move to Effect Option. Then Effect Submenu will pop out on the screen.
3. Use T/W key to move between four settings. The change can be previewed immediately.
4. Press Enter Button to validate the setting and exit.

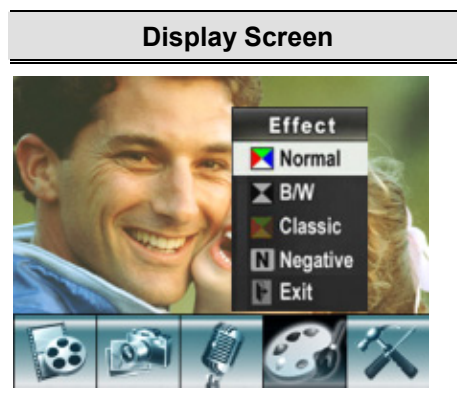

◆ Setting Menu

The Setting submenu contains options for configuring your camera set up.

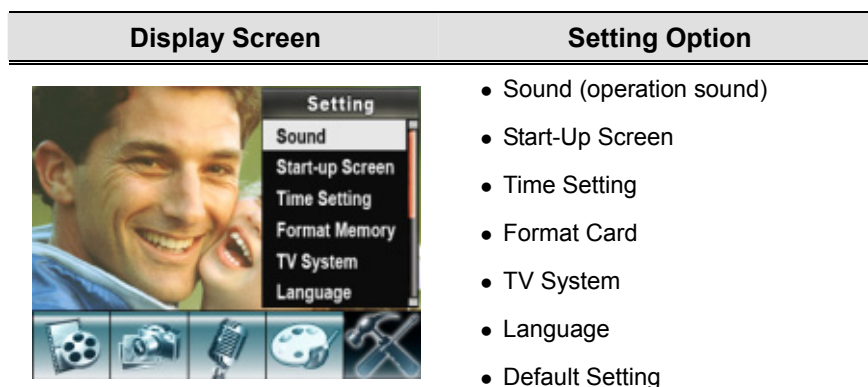

To change advanced setting:

1. In Movie/Picture Record Mode, press Enter Button to switch to record menu screen.
2. Use Right/Left Buttons to move to Setting option, then Setting Submenu will pop out on the screen.
3. Use T/W key to move between settings.



- **Sound Setting**

Enable or disable operation sound by using T/W key, the press Enter Button to validate the setting.

Submenu	Display Screen	Sound Setting
<p data-bbox="347 405 438 434">Sound</p>		

- **Start-up Screen**

Customize the Start-Up Screen with your favorite pictures. Press Right/Left Buttons to select the picture you want and press Enter Button to validate the setting and exit.

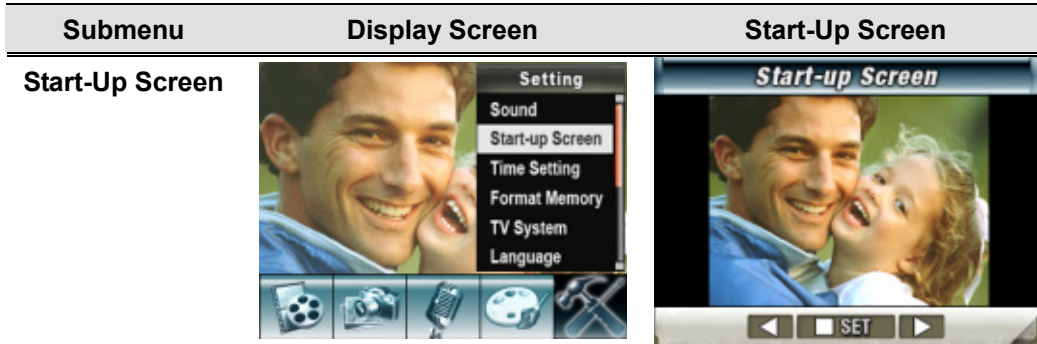

If you do not want to customize the start up screen, press Left/Right Buttons and select No Start-Up Screen.



- **Time Setting**



Move between Date, Time, Set and Exit by using Left/Right Buttons.

Adjust date and time by using T/W key, then select Set to validate each change.

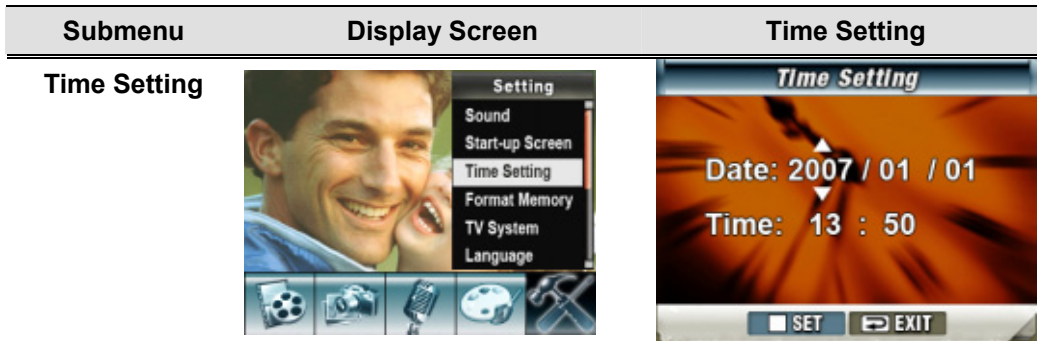
Select Exit to leave Time Setting without any change.



- **Format Memory**

Submenu	Display Screen	Format Card Options
Format Memory		

Yes : Format the SD Card / built-in memory

No (Default) : Do not format SD Card / built in memory



Note

- All the data will be erased if the SD card is formatted. Make sure all the data are duplicated to PC before formatting SD card.



- **TV System**

Ensure that the appropriate TV standard of your area is selected – either NTSC or PAL.

Wrong TV system setting may cause image flicker.

NTSC standard: USA, Canada, Japan, South Korea and Taiwan etc.

PAL standard: UK, Europe, China, Australia, Singapore and Hong Kong etc.

Submenu	Display Screen	TV System Option
TV System		



- **Selecting Interface Language**

You can select what language you want by using T/W key, the press Enter Button to validate the setting.

Submenu	Display Screen
Language	

- **Default Setting**

To restore the default factory setting, select this option.

Submenu	Display Screen	Default Setting Options
Default Setting		

Section 4

Playback Mode

Press RECORD/PLAY Button to switch from Record Mode to Playback Mode.

The Playback Mode is for viewing and managing movies and pictures as well as listening to voice on the built-in memory or on an optional memory card.

Operation	Display Screen
<p>Press RECORD/PLAY Button to switch from Record Mode to Playback Mode Main Menu.</p> <ul style="list-style-type: none">• There are three options in the Playback Mode, movie, picture, voice.• T/W key and Right/Left Buttons can be used to select the specific option.• Press Enter Button to view movies/pictures, listen to voice.	 The image shows a digital display screen with a light blue background. At the top, there are three large, rounded square icons: a camera lens, a film reel, and a microphone. Below these icons is a horizontal scroll bar with the word "MOVIE" written in a stylized, serif font on a light brown banner.







Note

When any recorded movie, picture, voice, is stored in the camera, a folder will be shown on the respective playback mode.

◆ Button Functions

These Buttons have the following functions in Movie and Picture Playback Modes.

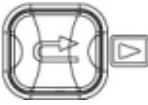
	<p>Movie Shutter Button : Start playing the recorded movie or voice</p>
	<p>Tele-Wide Button: Information T/W : Up/Down Up Button : Invalid Down Button : Information ON/OFF</p>
 	<p>Right Button : Go to the next movie/ picture. Movie fast forward Left Button : Go to the previous movie/ picture. Movie fast backward Enter Button : Enter to movie, picture, voice option menu.</p>
	<p>RECORD/PLAY Button functions: 1. Switch between Record and Playback modes. 2. Return to the previous page.</p>

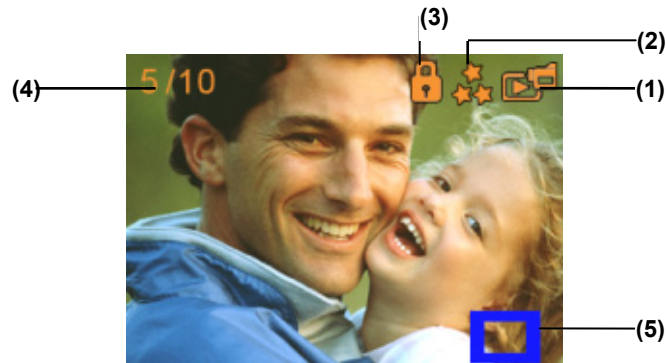

◆ LCD Monitor Information

Indicators on the LCD screen while in Playback Mode :





(1)	Mode Indicator						
	<table border="1"> <tr> <td></td> <td>Movie Playback Mode</td> </tr> <tr> <td></td> <td>Picture Playback Mode</td> </tr> <tr> <td></td> <td>Voice Playback Mode</td> </tr> </table>		Movie Playback Mode		Picture Playback Mode		Voice Playback Mode
	Movie Playback Mode						
	Picture Playback Mode						
	Voice Playback Mode						
(2)	Resolution Indicator						
	<table border="1"> <tr> <td></td> <td>High Resolution</td> </tr> <tr> <td></td> <td>Standard Resolution</td> </tr> <tr> <td></td> <td>Low Resolution</td> </tr> </table>		High Resolution		Standard Resolution		Low Resolution
	High Resolution						
	Standard Resolution						
	Low Resolution						
(3)	Indicate the selected movie/picture is locked.						
(4)	Current Number/ Total number of movie, picture, voice.						
(5)	Magnification Indicator.						

◆ Movie Playback

Operation	Display Screen
<ol style="list-style-type: none"> 1. Use T/W key or Right/Left Buttons to select the Movie option. 2. Press Enter Button to go to Movie Playback Mode. 	 <p>The screen displays three blue icons: a camera, a film reel, and a play button. Below the icons is a brown banner with the word "MOVIE" in white capital letters.</p>
<ol style="list-style-type: none"> 3. Use Right/Left Buttons to go to the next or last movie. 4. Press Movie Shutter Button to play and press it again to pause. 5. While playing movie, press Right/Left Buttons to fast forward/backward, then release the button to stop. 6. Use T/W key to adjust volume. 	 <p>The screen shows a close-up of a smiling man and a laughing child. In the top left corner, it displays "5/10". In the top right corner, there are several small icons. In the bottom right corner, there is a circular control overlay with a play button in the center, and arrows for fast forward and fast backward. Below the play button are "Vol+" and "Vol-" labels.</p>
<ol style="list-style-type: none"> 7. Press Enter Button to go to the movie option menu. 8. Use Right/Left Buttons to select six options, Delete, Thumbnail, Lock, Repeat One, Repeat All, or Exit. 	 <p>The screen shows the same close-up of the man and child. At the bottom, there is a horizontal menu with a brown banner that says "Delete". Below the banner are six blue icons representing different options: a trash can, a hand, a film reel, a play button, a film reel, and a trash can.</p>

◆ Delete Movies

Operation	Display Screen
<p>1. Use Right/Left Buttons to select the Delete option ().</p>	
<p>2. Press Enter Button to go to the Delete menu.</p> <p>3. Use Right/Left Buttons to select the movie.</p> <p>4. Use Up Button to delete all movies and Down Button to delete single movie.</p> <p>5. Before a movie is deleted, a confirmation screen will appear; choosing “Yes” will execute the operation and “No” to cancel the operation.</p> <p>6. Press Enter Button to exit.</p>	



Note

If a memory card is fitted, you can delete only those movies stored on the card.



Note



Movies on a written-protected memory card cannot be deleted.



Note



The delete function will only erase unlocked movies. Locked movies must be unlocked before being deleted.

◆ Thumbnail Function

Operation	Display Screen
<p>1. Use Right/Left Buttons to select the Thumbnail option ().</p>	
<p>2. Press Enter Button to view nine thumbnail movies. 3. To play a movie, use Right/Left Buttons to select the movie and press Enter Button and then movie shutter button to view.</p>	

◆ Lock Movies

Single or all movies can be locked. This function can prevent the movies from being deleted accidentally.

Operation	Display Screen
<p>1. Use Right/Left Buttons to select the Lock option ().</p> <p>2. Press Enter Button to go to the Lock menu.</p>	
<p>3. Use Right/Left Buttons to select the movie.</p> <p>4. Use Up Button to lock/unlock all movies and Down Button to lock/unlock single movie.</p> <p>5. Before a movie is locked/unlocked, a confirmation screen will appear; choosing “Yes” will execute the operation, “No” will cancel the operation.</p> <p>6. Press Enter Button to exit.</p>	

◆ Repeat Movies



This function automatically repeats playing single movie or all movies in order.

Operation	Display Screen
<p>1. Use Right/Left Buttons to select the Repeat One option (↺) or Repeat All option (↻).</p> <p>2. Press Enter Button to start repeating.</p>	

◆ Picture Playback

Operation	Display Screen
<ol style="list-style-type: none"> 1. Use T/W key or Right/Left Buttons to select the Picture option. 2. Press Enter Button to go to Picture Playback Mode. 	
<ol style="list-style-type: none"> 3. Use Right/Left Buttons to go to the next or last picture. 4. While the picture is selected, use Tele/Wide Buttons to magnify. 5. For navigation, press enter key and then use T/W key and Right/Left buttons to navigate the magnified picture. 	
<ol style="list-style-type: none"> 6. Press Enter Button to go to the picture option menu. 7. Use Right/Left Buttons to select five options, Delete, Thumbnail, Lock, Slideshow, or Exit. 	

◆ Delete Picture

Operation	Display Screen
<p>1. Use Right/Left Buttons to select the Delete option ().</p>	
<p>2. Press Enter Button to go to the Delete menu.</p> <p>3. Use Right/Left Buttons to select the picture.</p> <p>4. Use Up Button to delete all pictures and Down Button to delete single picture.</p> <p>5. Before a picture is deleted, a confirmation screen will appear; choosing “Yes” will execute the operation, “No” will cancel the operation.</p> <p>6. Press Enter Button to exit.</p>	



Note

If a memory card is fitted, you can delete only those pictures stored on the card.



Note



Pictures on a written-protected memory card cannot be deleted.



Note

The delete function will only erase unlocked pictures. Locked pictures must be unlocked before being deleted.

◆ Delete Picture

Operation	Display Screen
1. Use Right/Left Buttons to select the Delete option ().	
2. Press Enter Button to go to the Delete menu. 3. Use Right/Left Buttons to select the picture. 4. Use Up Button to delete all pictures and Down Button to delete single picture. 5. Before a picture is deleted, a confirmation screen will appear; choosing “Yes” will execute the operation, “No” will cancel the operation. 6. Press Enter Button to exit.	



Note

If a memory card is fitted, you can delete only those pictures stored on the card.



Note



Pictures on a written-protected memory card cannot be deleted.



Note

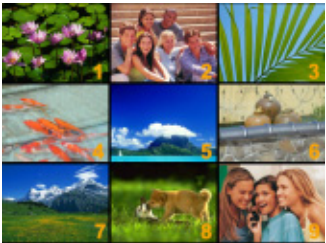

The delete function will only erase unlocked pictures. Locked pictures must be unlocked before being deleted.

◆ Thumbnail Function

Operation	Display Screen
1. Use Direction Buttons to select the Thumbnail option ().	
2. While selecting Thumbnail option, press Enter Button to view nine thumbnail pictures. 3. To view a picture, use Direction Buttons to select the picture. 4. Press Enter Button to view the selected picture.	

◆ Lock Pictures

Single or all pictures can be locked. This function can prevent the pictures from being deleted accidentally.

Operation	Display Screen
1. Use Right/Left Buttons to select the Lock option ().	
2. Press Enter Button to go to the Lock menu. 3. Use Right/Left Buttons to select the picture. 4. Use Up Button to lock/unlock all pictures and Down Button to lock/unlock single picture. 5. Before a picture is locked/unlocked, a confirmation screen will appear; choosing “Yes” will execute the operation, “No” will cancel the operation. 6. Press Enter Button to exit.	

◆ Make Slide Show

This function automatically repeats all pictures in order.



Operation	Display Screen
<ol style="list-style-type: none">1. Use Right/Left Buttons to select the Slide option (▶◀).2. Press Enter Button to start the slide show; Press it again to stop.	 The image shows a digital display screen. The top portion of the screen displays a photograph of a man and a young girl smiling together. Below the photograph is a dark horizontal bar with the word "Slideshow" written in a light-colored font. Underneath this bar is a row of five small, light-colored icons: a play button, a left arrow, a right arrow, a stop button, and a refresh button.

◆ Voice Playback

T/W key and Right/Left Buttons Function

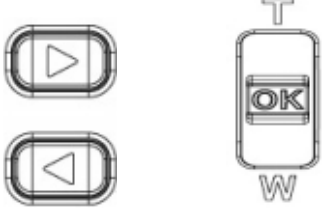
In Voice Playback Mode, the T/W key and Right/Left Buttons have the following functions:

	<p>Right/ Left Buttons : Select the last or next voice.</p> <p>T/W key : Adjust the voice playback volume.</p> <p>Enter Button : Switch to voice option menu.</p>
-----------------------------------------------------------------------------------	----------------------------------------------------------------------------------------------------------------------------------------------------------------------------------------

Operation	Display Screen
<ol style="list-style-type: none"> 1. Use T/W key or Right/Left Buttons to select the Voice option. 2. Press Enter Button to go to Voice Playback Mode. 	
<ol style="list-style-type: none"> 3. Use Right/Left Buttons to go to the next or last voice recording. 4. Press Movie Shutter Button to start playing back the selected voice. Press it again to stop. 5. Use T/W key to adjust the volume. 6. Press Enter Button to go to the voice playback option menu. 	
<ol style="list-style-type: none"> 7. Use Up Button to select Delete option and Down Button to select Repeat option. 	

8. Press Up Button once to repeat single voice; Press twice to repeat all voice recording.
9. Press it again to disable the repeat function.
10. The repeat icons will be different while selecting Repeat One option and Repeat All option.







11. To delete a voice, use Right/Left Buttons to select the voice.
12. Use Up Button to delete all voice recordings and Down Button to delete single voice recording.
13. Before a voice is deleted, a confirmation screen will appear; choosing "Yes" will execute the operation, "No" will cancel the operation.
14. Press Enter Button to exit submenu.
15. Press Record / Play Button to exit Voice mode.



Section 5

Listening to MP3 Music

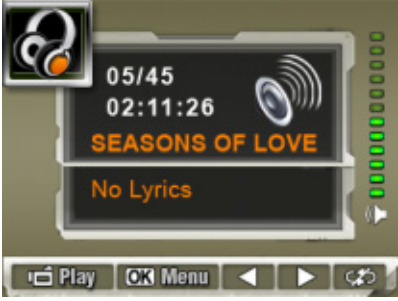
◆ MP3 Music

Operation	Display Screen
<p>1. Use T/W key or Right/Left Buttons to select the Voice option.</p> <p>2. Press Enter Button to go to Voice Playback Mode</p>	
<p>2. Use T/W key to locate MP3 you want to play, or press Right/Left Buttons to jump to the next/previous page.</p> <p>There is an icon  in the front for those MP3 with Lyrics display.</p>	
<p>3. Press T/W key to play MP3</p> <p>4. Use T/W key to adjust the volume.</p> <p>5. Press Enter Button to go to the voice playback option menu.</p>	
<p>11. To delete a voice, use Right/Left Buttons to select the voice.</p> <p>12. Use Up Button to delete all MP3 and Down Button to delete single MP3.</p> <p>13. Before a MP3 is deleted, a confirmation screen will appear; choosing "Yes" will execute the operation, "No" will cancel the operation.</p> <p>14. Press Enter Button to exit submenu.</p> <p>15. Press Record / Play Button to exit.</p>	



◆ Listen to MP3 Music with earphone

MP3 stored in the camera can be played either by built-in speaker, or Earphone, or TV.

When the earphone cable is plugged in the camera, the option menu of Earphone/TV pops out on the LCD Screen. Choose earphone or TV and press OK Button to validate the setting.



Section 6

Reading eBook



◆ eBook





An eBook is an electronic edition of a physical book. eBooks in your camera have many features that traditional paper books do not: you have the freedom to control the look and feel of your eBook through colors, your own bookmarks, carrying your eBooks anywhere with your camera.

◆ Transfer eBooks to the camera

1. Install the camera driver on your computer.
2. Connect your camera to the computer USB port.
3. The Red LED will light when the camera is connected to the computer and in Mass Storage Mode.
4. Transfer eBooks, .txt file format only, to My Computer\Removable Disk\Book.
5. Once all the files are transferred, disconnect the USB cable from the PC.

◆ Read eBooks

Operation	Display Screen
<p>1. In Playback Mode, use T/W Key to select the eBook option</p>	
<p>2. Use T/W Key select eBook you want to read, or press Right/Left Buttons to jump to the next/previous page. There is an icon  in the front for those eBooks with bookmark added.</p>	

3. Press Enter Button to read the eBook.
4. Press T/W keys to scroll up/down the text
5. Select  to jump to the first page
6. Select  to jump to the last page
7. Select  to change the color of text and background.
8. Select  to auto scroll down the text.
9. Select  to add a bookmark.

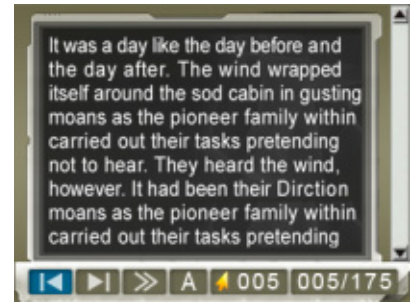

Viewing MPEG4 Movie on PC

◆ MPEG4 Movie

MPEG4, the multimedia format and compression standards, is a cutting-edge compression technology developed by MPEG (Motion Picture Expert Group). It not only enhances the image quality but also improves the efficiency of recording capacity.

MPEG4 is adopted in this camera to take DVD-quality MPEG4 movies. The MPEG4 movie format of AVI is used in this camera.

◆ View MPEG4 Movie on PC

When playing an MPEG4 movie for the first time, MPEG4 Video Codec Xvid should be installed in PC. To do this:

- (1) Insert the CD-ROM into the computer's CD-ROM drive. Click "Install Device Driver" (Install MPEG4 Video Codec Xvid) and follow the on-screen instructions to complete the installation.
- (2) Start video player such as Widows Media Player to view MPEG4 AVI Movies.

◆ Share MPEG4 Movie

You can share the recorded MPEG4 movies to your friends via internet or CD. Make sure MPEG4 Video Codec Xvid is installed in your friends' PC. MPEG4 Video Codec Xvid is available in the provided CD or can be downloaded from Internet.

Section 8

Viewing Pictures and Movies on a TV

You can view stored movies and pictures on a television. To connect to a television:

1. Connect one end of the AV cable to your camera's AV Out port.
2. Connect the other end of the cable to a television.
3. The option menu of Earphone/TV pops out on the LCD Screen.

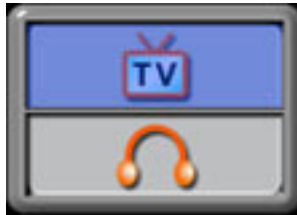

4. Choose TV option and press Enter Button to validate the setting.
5. The steps for viewing stored pictures and movie on a TV are exactly the same as for viewing them on the LCD monitor.



Note

1. *The LCD monitor does not work when the camera is connected to a television.*
2. *Taking picture with high resolution is not supported while the camera connects to a TV.*

Section 9

Video File Converter

Bundled software CD contains Acrsoft Media Converter that features video file converter to convert multiple video formats into MPEG4 Xvid compatible format with your camera. In this way, you can convert various video files formats and playback your favorite movies on your camera.

For windows XP, 2000 and Vista System users, please refer to 9.1 Media Converter2

For windows 98 and Windows Me Users, please refer to 9.2 Media Converter 1

9.1 Media Converter 2

To convert a video file:

- (1) Install Arcsoft Media Converter2
- (2) Click Start → Select Programs→Arcsoft Media Converter2→Media Converter2
- (3) Media Converter main Screen will appear on your desktop
- (4) Select “Zoran Coach Compatible” at “Select Device” column. The “Select Conversion Parameter” will change to “Coach 7Camera” respectively.

Compatible Device Selection

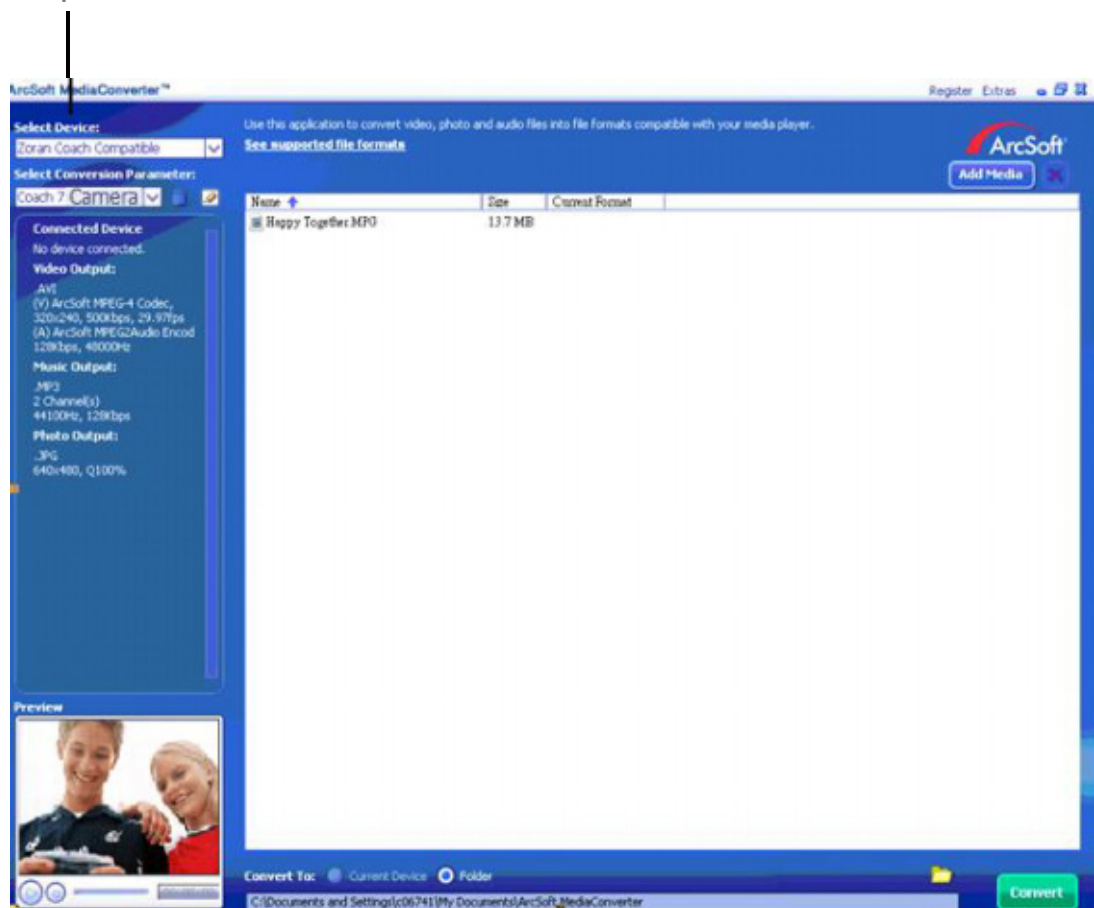

(5) Click "Add Media"

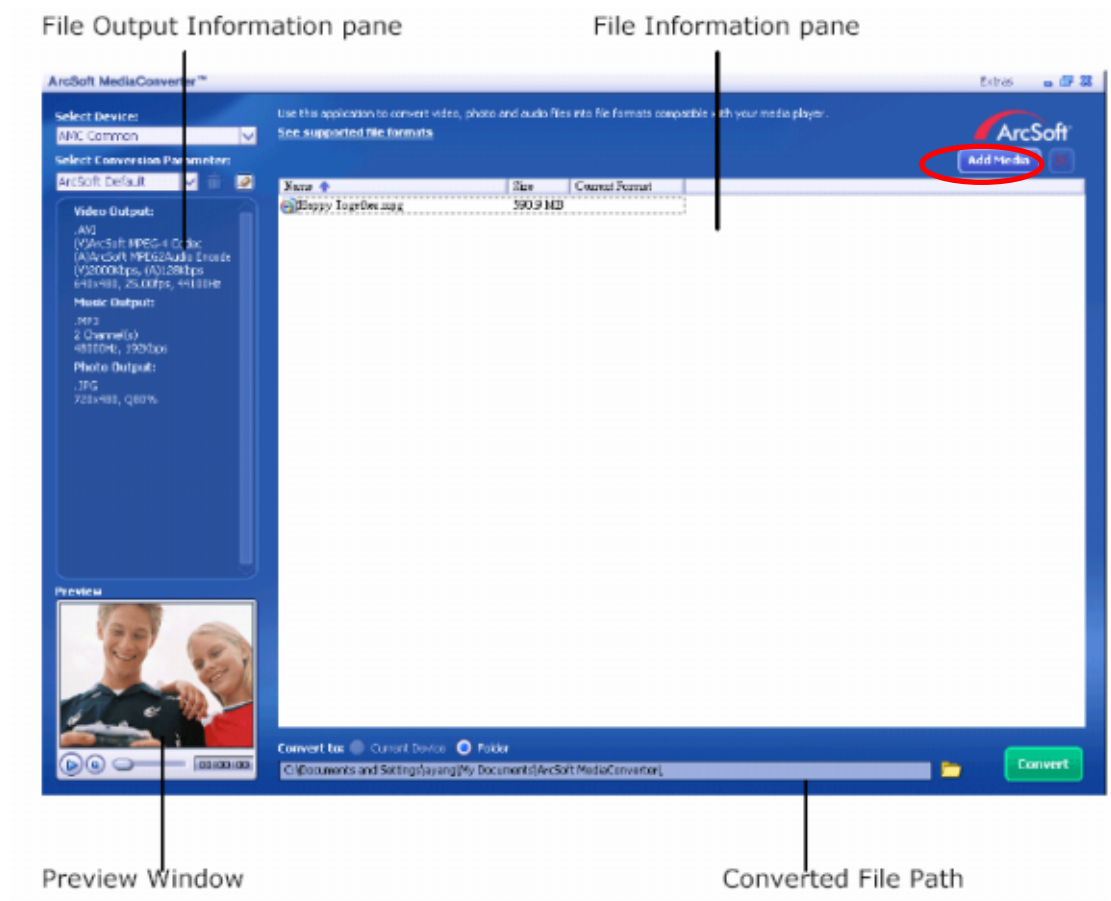

(6) Select Video file you want to convert

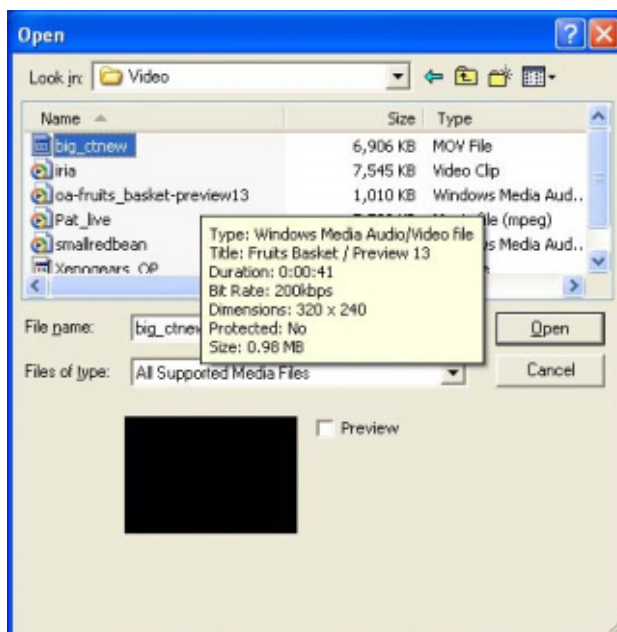

(7) You can preview your media files before converting. To preview media files, use the following control functions.

* Click  to start previewing

*Click  to stop previewing

Make sure your media files can be previewed before converting

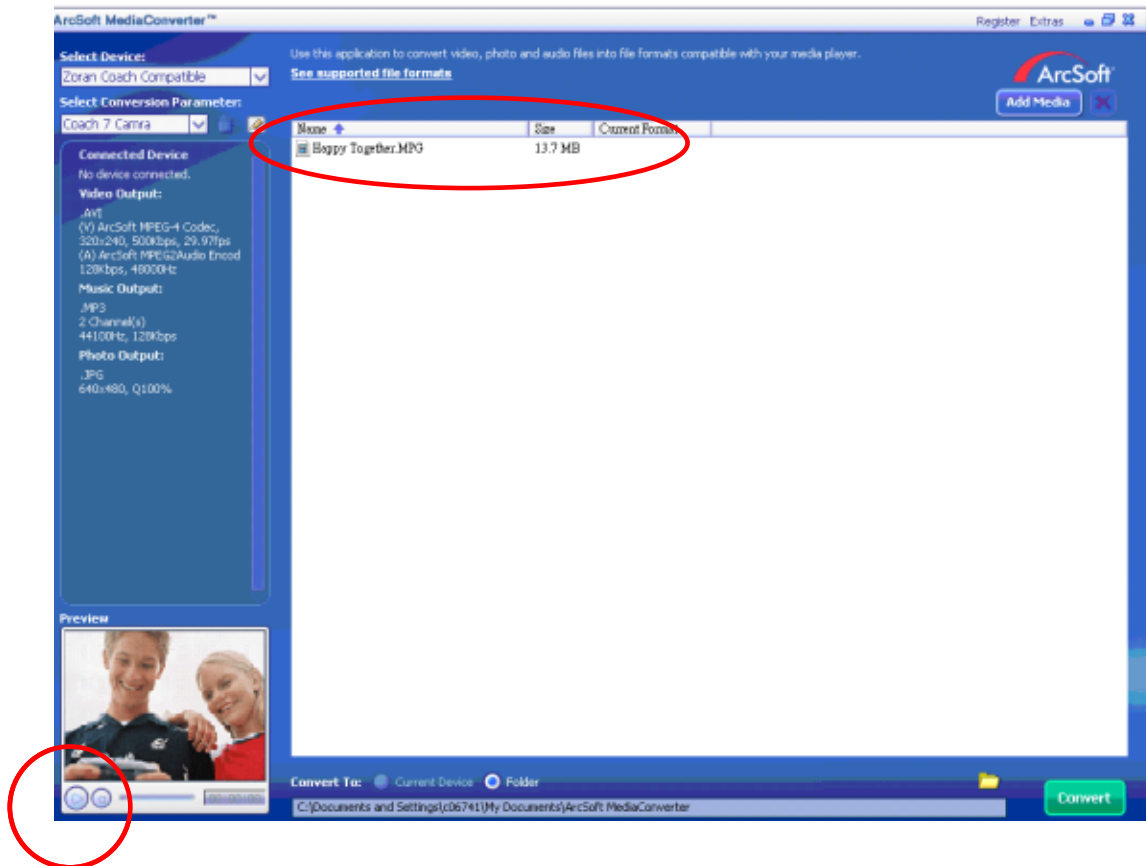

- (8) Click on  to begin converting files

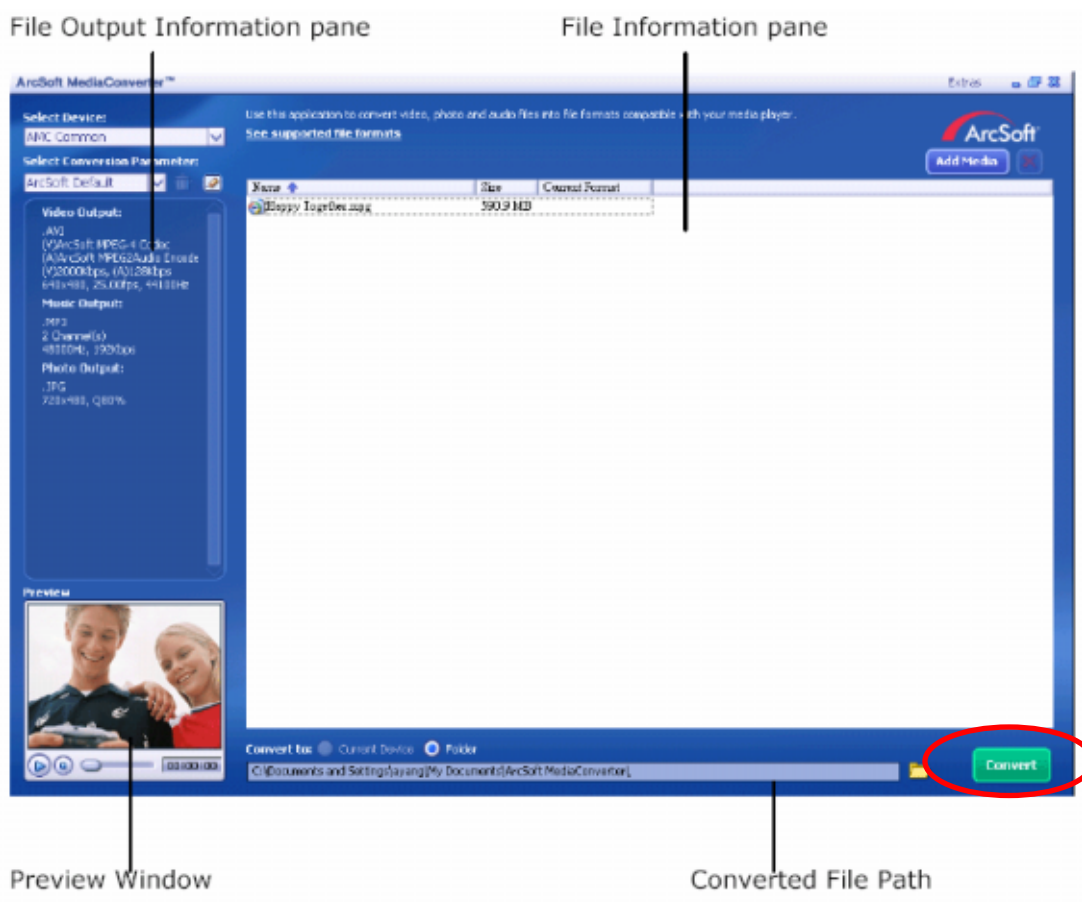

- (9) Task Report window will pop out after the task is completed.
- (10) Before transferring the converted file to your camera, rename the converted file to “Clip0001.avi”. (Please note: if Clip0001.avi exists in the camera, then the converted file has to be renamed to clip0002.avi)
- (11) Connect your camera to PC and transfer the converted video to “My Computer\Removable Disk\DCIM\200Movie” in your camera.
- (12) After transferring the converted video to the camera, press RECORD/Play → REC/PLAY Button to enjoy your favorite movie.

9.2 Media Converter 1

To convert a video file:

- (1) Install Arcsoft Media Converter
- (2) Click Start→ Select Programs→ Acrsoft Media Converter→ Media Converter
- (3) Media Converter main Screen will appear on your desktop.
- (4) Click “Select Media”

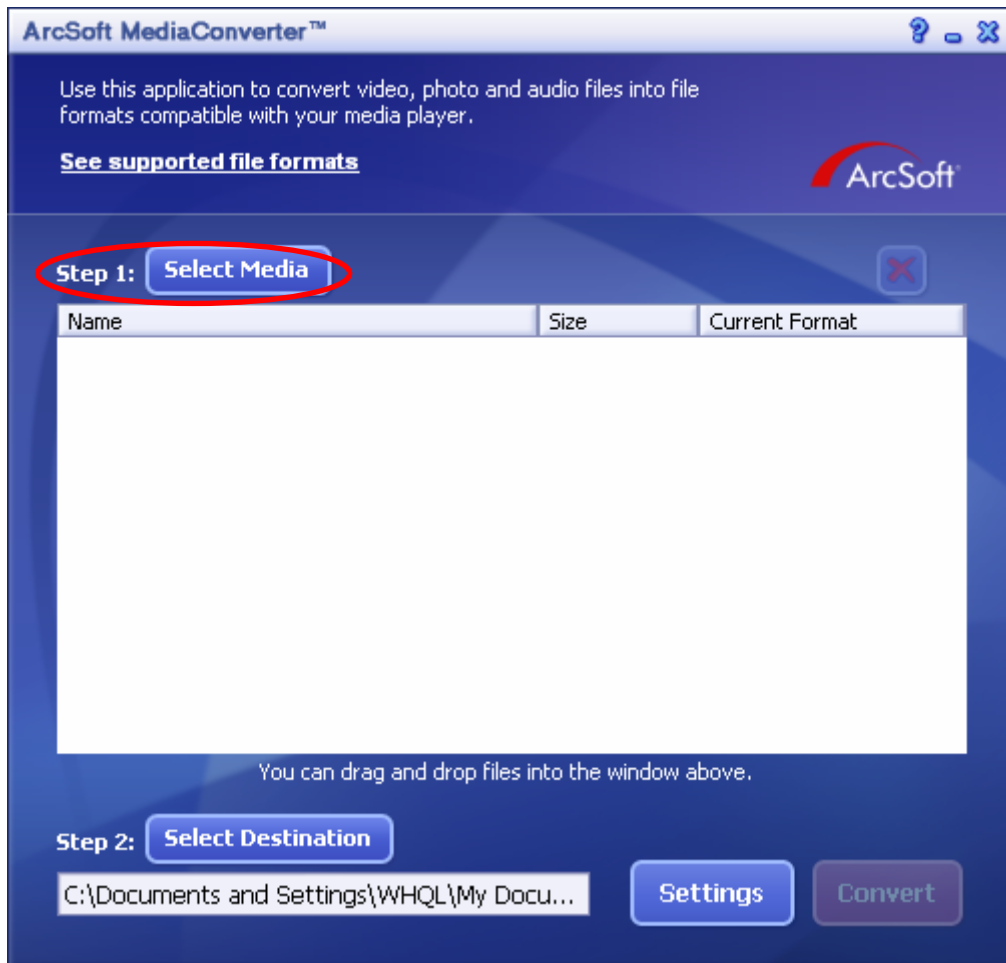

(5) Select the video file you want to convert.

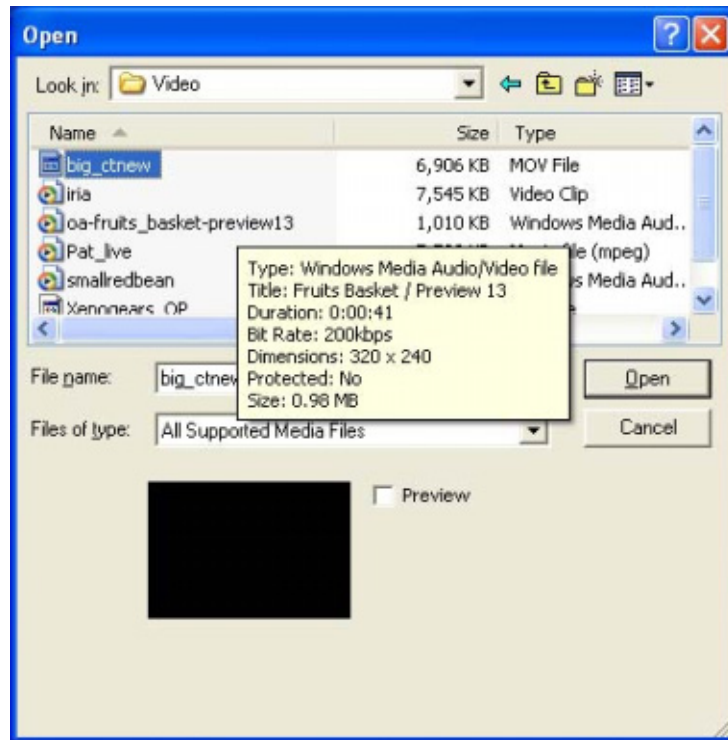

(6) Click "Select Destination" to choose the location you want to store the converted video file.

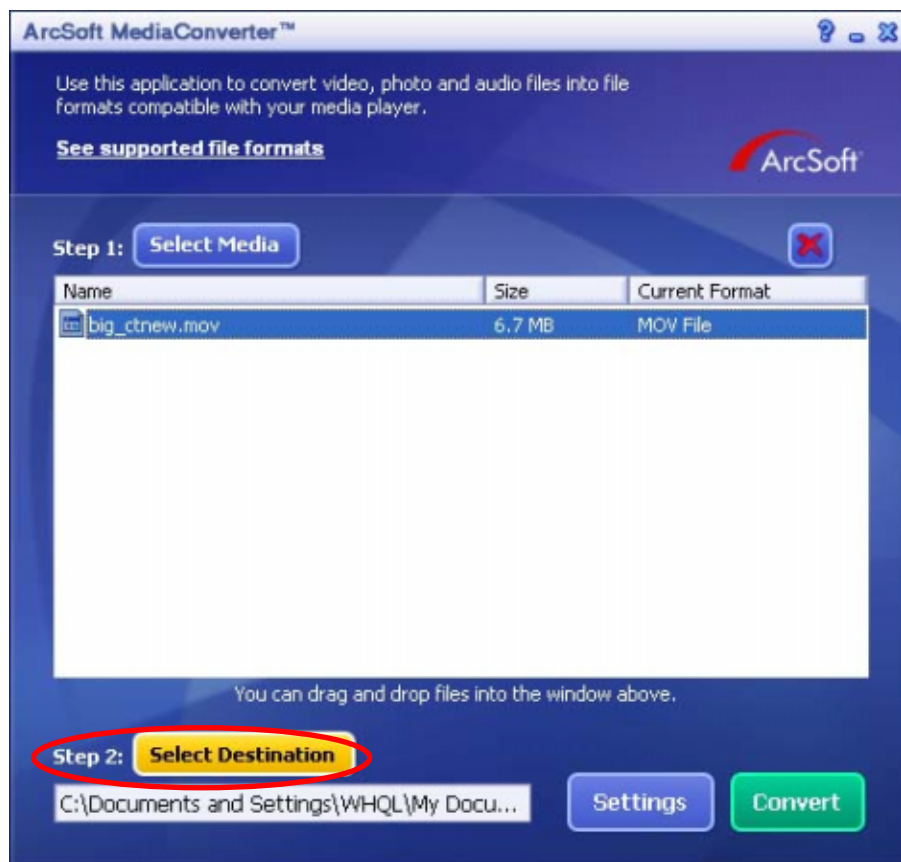

(7) Click "Convert" to start video converting.

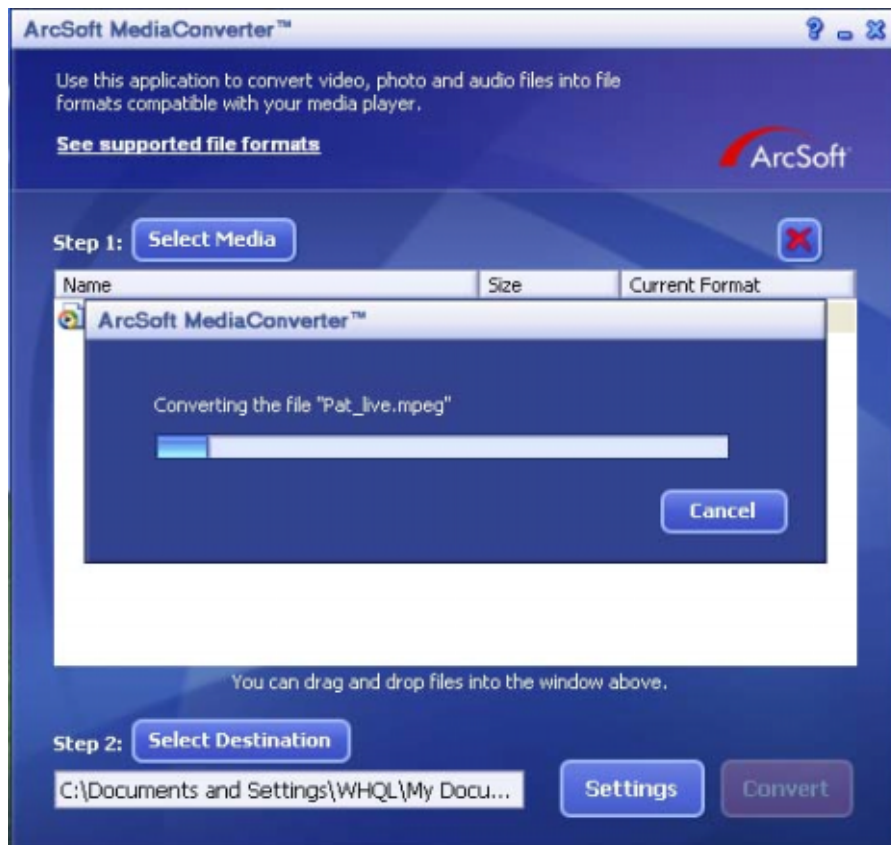
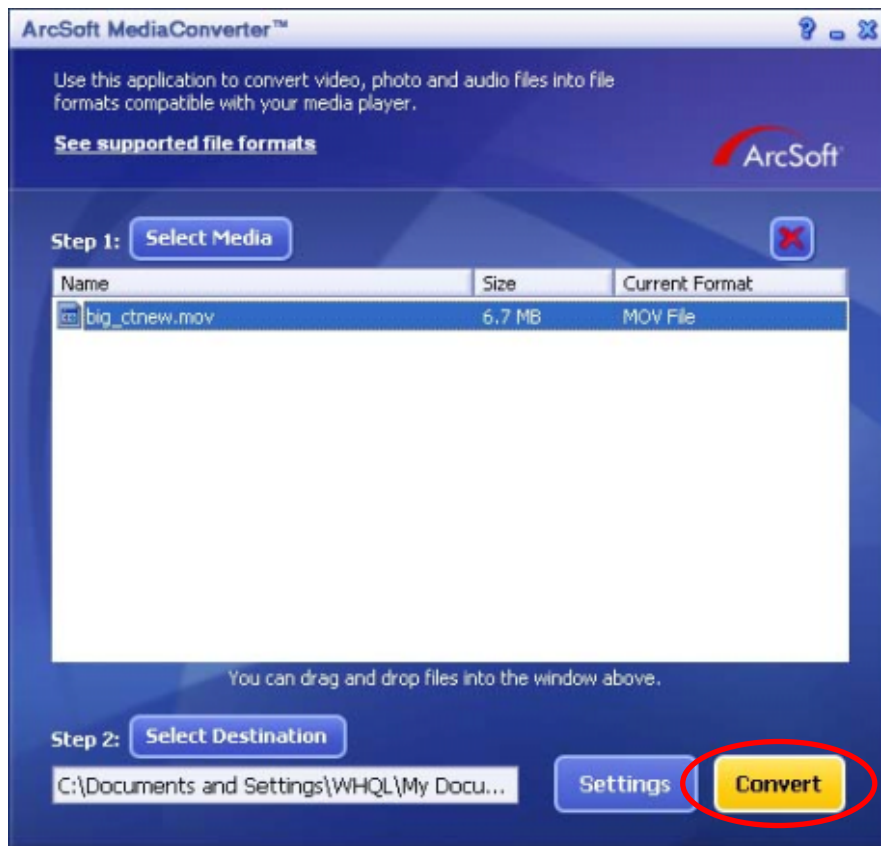

(8) Task Report window will pop out after the task is completed.

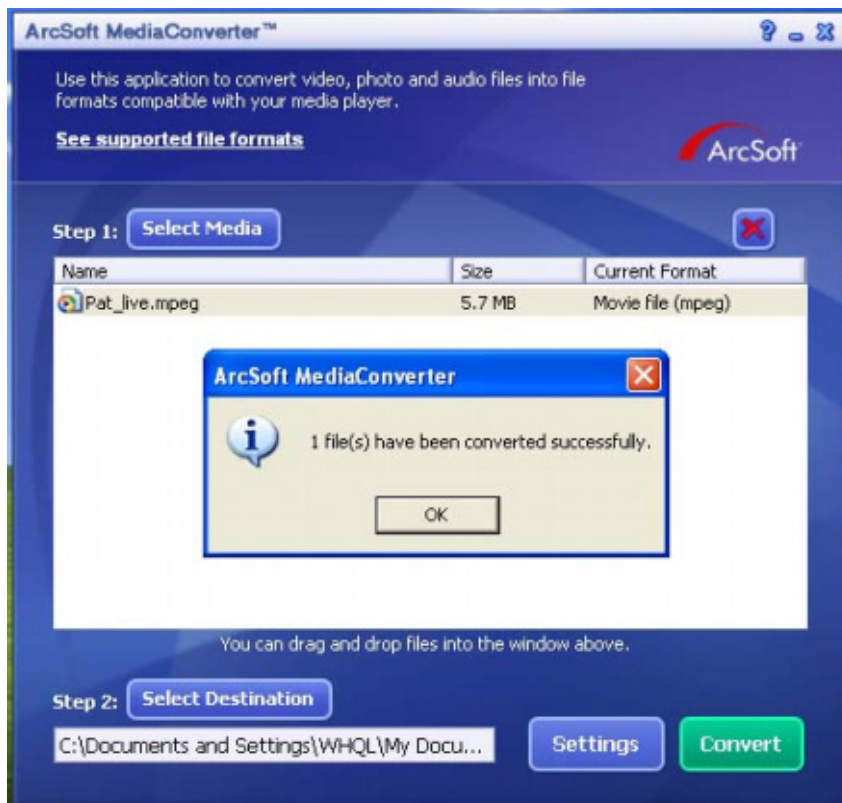

(9) Before transferring the converted file to your camera, rename the converted file to "Clip0001.avi". (Please note: if Clip0001.avi exists in the camera, then the converted file has to be renamed to clip0002.avi)

(10) Connect your camera to PC and transfer the converted video to "My Computer\Removable Disk\DCIM\200Movie" in your camera.

(11) After transferring the converted video to the camera, press RECORD/Play → REC/PLAY Button to enjoy your favorite movie.

Section 10

Burning the Recorded Clip into DVD

Bundled software CD contains ArcSoft Showbiz DVD also features burning the movie clip into DVD. You can preserve your precious movies on DVD to share with family and friends. To create a DVD:

- (1) Install Arcsoft Showbiz DVD
- (2) Click Start→ Select Programs→ Acrsoft Showbiz DVD→ Showbiz DVD
- (3) Showbiz DVD main Screen will appear on your desktop.
- (4) Drag Video File to “ Drag Video Here”

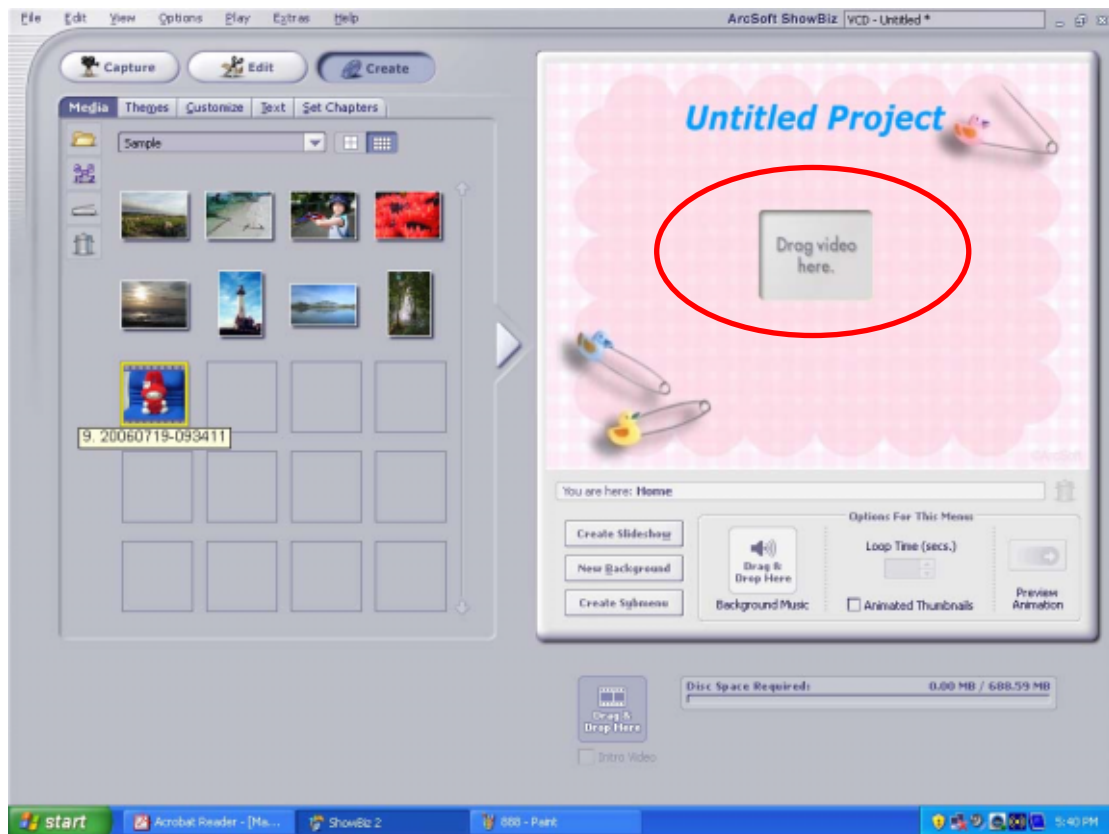

(5) Click "Create"

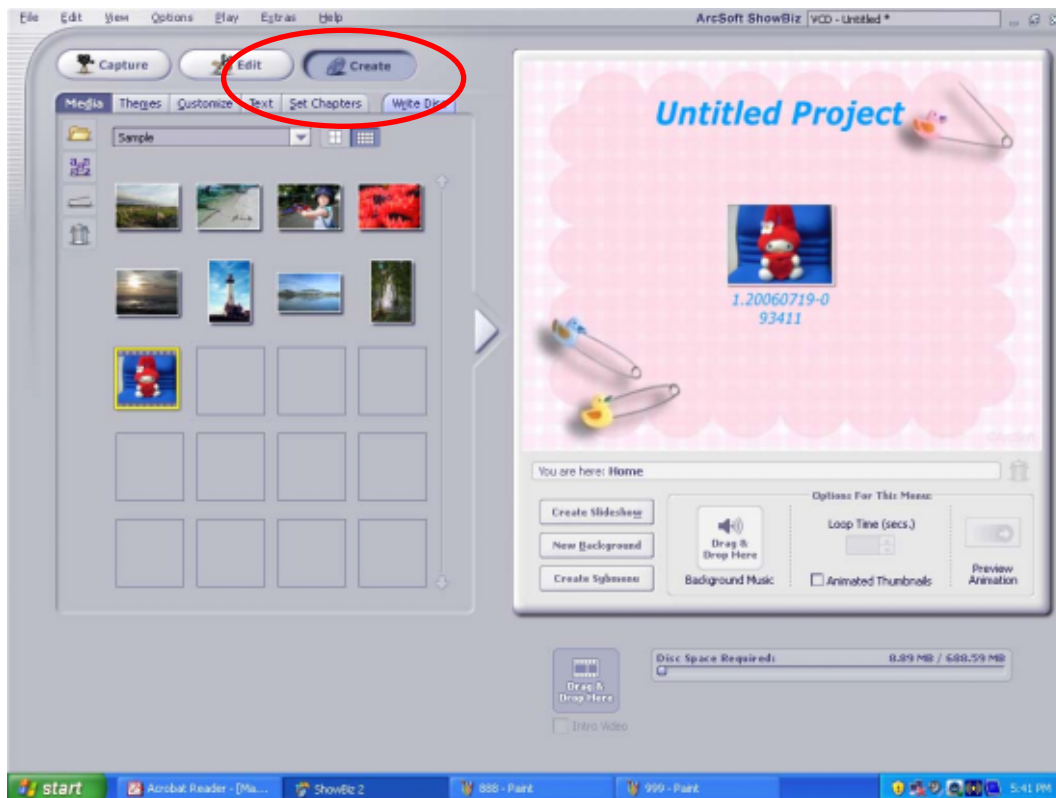

(6) Click "Start" to start DVD burning

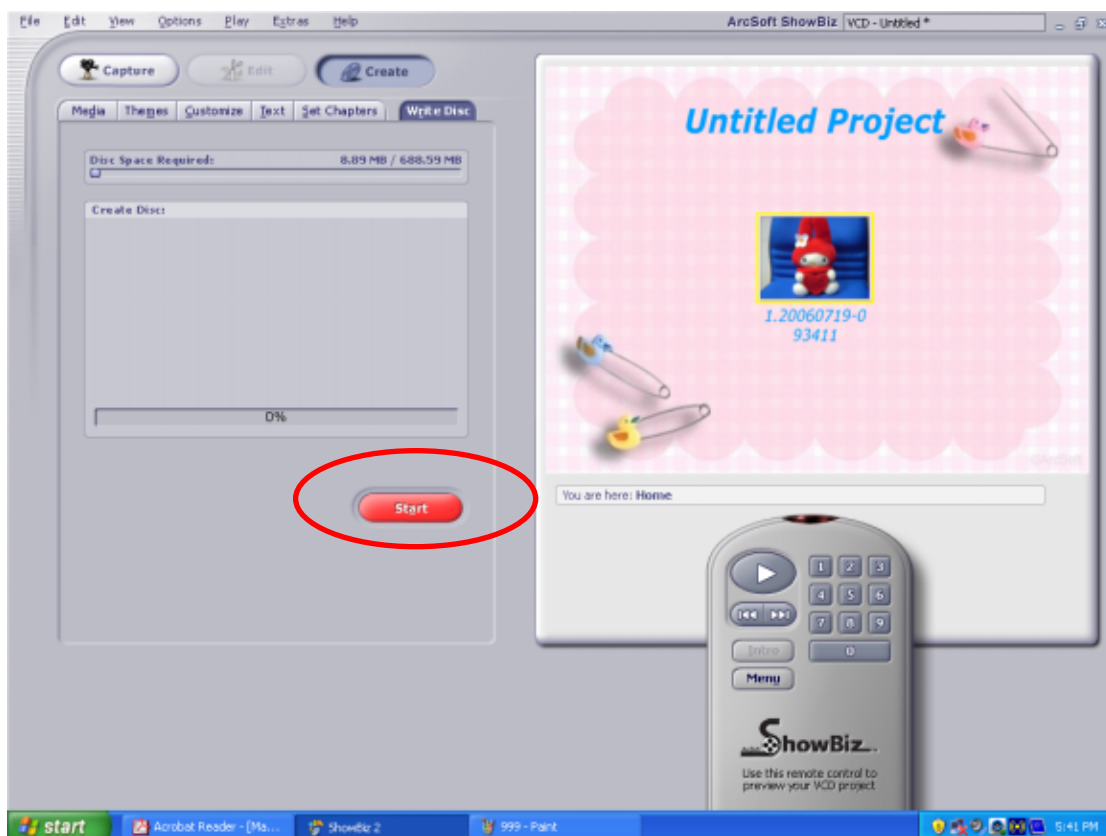

Section 11

Transferring Data to a Computer

◆ Installing the Digital Camera Driver

Before connecting this camera to a computer for the first time, you should install a driver on the computer. The driver is on the CD-ROM disc provided in the package. To install the driver:

1. Insert the CD-ROM into the computer's CD-ROM drive. The autorun screen will appear.
2. Click "Install Device Driver". Follow the on-screen instructions to complete the installation. Depending on your operating system, you may have to restart your computer after installing the driver.

◆ Connecting Your Camera to a Computer

You can transfer pictures, movies or voice recordings stored on your camera to a computer and send them in emails to friends or post them on websites. To do this you should:

1. Install the camera driver on your computer.
2. Connect the computer and camera with the supplied mini USB 2.0 cable.
3. Default mode is Mass Storage Mode when the camera connects to PC
4. Transfer pictures or movies or MP3 or voice recordings

◆ Mass Storage Device Mode

The RED LED will light up when the camera is connected to the computer. Movies, pictures and voice recordings can be found on your computer at "My Computer\Removable Disk\DCIM". Under this mode, you can read, delete, move, or copy any movie/picture/voice recording you want. Use the bundled Arcsoft application software to edit the movies or pictures.

◆ PC Camera Mode

When in Mass Storage Device Mode, press RECORD/PLAY Button to switch to PC Camera Mode and the GREEN LED will light up. Under this mode, you can implement live video conference meetings or use video email over the Internet.

◆ Installing Bundled Software

The CD-ROM supplied with this camera contains 5 pieces of software.

- ⇒ **Acrsoft PhotoImpression** is a user-friendly application that helps you read, edit and organize images.
- ⇒ **Acrsoft Show Biz** allows you to edit movies and is equally easy to use.
- ⇒ **Arcsoft Media Converter can** convert multiple video formats into MPEG4 Xvid compatible format with your camera
- ⇒ **Adobe Reader** is a popular program that you need to have installed to read the User's Manual. Many computer users will find they already have this software installed on their computer.
- ⇒ **MPEG4 Video Codec Xvid**, this decode software has to be installed for correctly viewing the movies you record.

The detail information can be found in online help of all the bundled software.

To install the bundled software:

1. Insert the CD-ROM into your computer's CD-ROM drive. The autorun screen appears.
2. Select the piece(s) of software you want to install from the list, then click **Install Application Software**. Follow the on-screen instructions to complete the installation.

Specifications and System Requirements

◆ Specification

Image Sensor	5.2 Mega Pixel Sensor
Operation Modes	Movie Record, Picture Record, Voice Record,MP3 Player, Webcam, Mass Storage Device
Lens	F3.2 (f=7.2mm)
Focus Range	Normal: 150cm~infinite Marco: center 20cm;
Zoom	8 x Digital Zoom
Shutter	Electrical
LCD monitor	2.4" TFT LCD
Storage Media	Built-in 64MB Memory (partial memory is used for Firmware code); SD/MMC Card Slot support (up to 4GB)
Image Resolution	3840x2880 (11M Pixels) 2592x1944 (5M Pixels) 1600x1200 (2M Pixels)
Movie Resolution	640x480 (VGA) 30 fps 320X240 (QVGA) 30 fps
White Balance	Auto/Manual (Daylight, Fluorescent, Tungsten)
Exposure	Auto/Manual
Self-Timer	10 second delay
Flash	Auto/On/Off/Red-Eye Reduction/Light On
File Format	Picture : JPEG Movie : AVI (Xvid) Voice : WAV,MP3
Image play	Single Image/Thumbnails/Slideshow
PC Interface	Mini USB 2.0 Port
TV out	NTSC/PAL Selectable
Battery	AA Battery
Dimension	90mm×56.6mm×25mm
Weight	110g (without battery)

◆ System Requirement

Windows 98SE/2000/ME/XP/Vista

Pentium III 800MHz or higher

256 MB RAM

CD ROM

1GB free HDD space

Available USB port