

Digital Video Camera

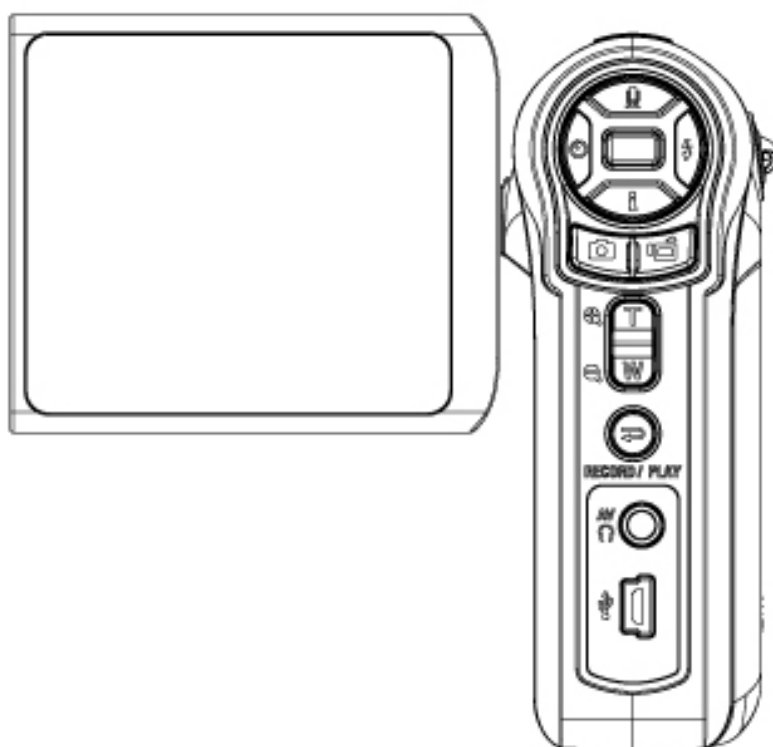

User Manual

Content

Section 1 Getting to Know Your Camera.....	2
Section 2 Getting Up and Running	5
Section 3 Record Mode.....	7
Section 4 Playback Mode	34
Section 5 Listening to MP3 Music	47
Section 6 Reading eBook	49
Section 7 Viewing MPEG4 Movie on PC.....	51
Section 8 Viewing Pictures and Movies on a TV	52
Section 9 Video File Converter.....	53
Section 10 Burning the Recorded Clip into DVD.....	57
Section 11 Transferring Data to a Computer.....	59
Section 12 Specifications and System Requirements	61

Getting to Know Your Camera

◆ Overview

The camera with 5 Mega Pixel sensor can take DVD-Quality MPEG-4 movies. By way of using MPEG-4 technology, more videos can be taken within certain amount of memory. High quality images with up to 11 mega-pixels can also be delivered smoothly. With a color LCD monitor, users can compose images and examine them easily.

Exposure and color balance can either be adjusted automatically or allowed to be changed manually. An 8x digital zoom increases user control over the movies and pictures you take. The camera is also ideally suited for using as a PC camera hooked up to your home computer via high speed USB 2.0 port

Build-in 64 MB memory allows you to take pictures and movies without memory card. The memory card slot allows users to increase the storage capacity up to 2GB.



Note

Partial memory of the built-in 64MB memory is used for Firmware code

◆ Standard Accessories

Unpack the package and make sure all standard accessories listed are included:

- Camera
- USB Cable
- Power Adaptor
- AV Cable
- Lithium-ion Rechargeable Battery
- Quick Guide
- CD-ROM (Driver, Arcsoft Software and User Manual)
- Remote Control (Optional)
- Earphone
- Strap
- Pouch

◆ **Front View**

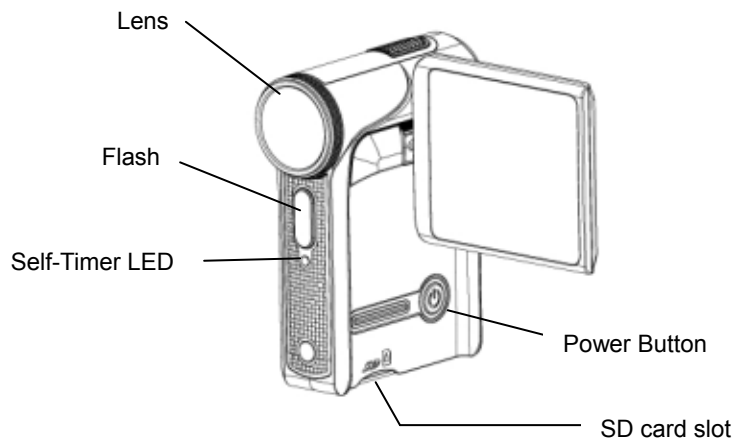

◆ **Keypad illustration**

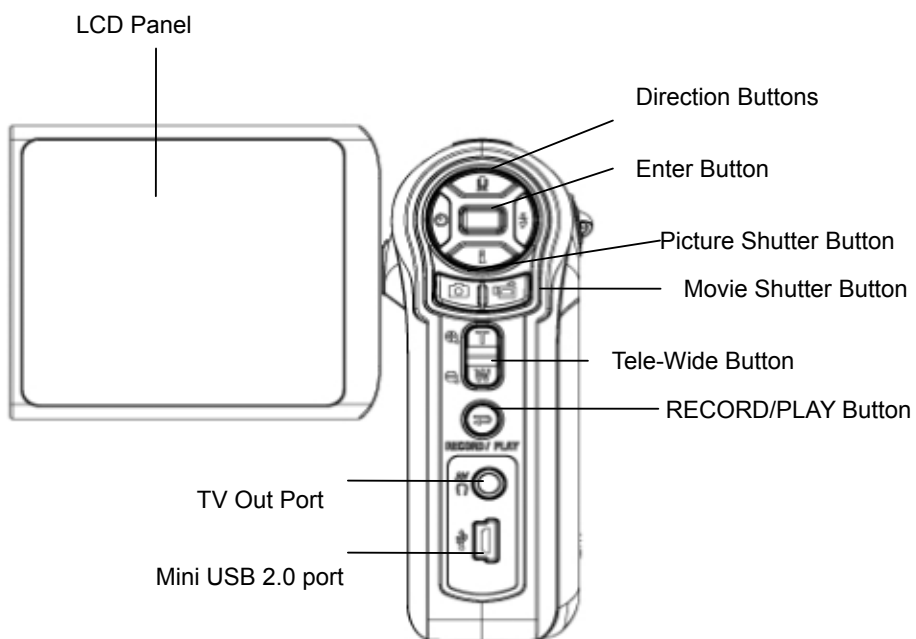

◆ Side View

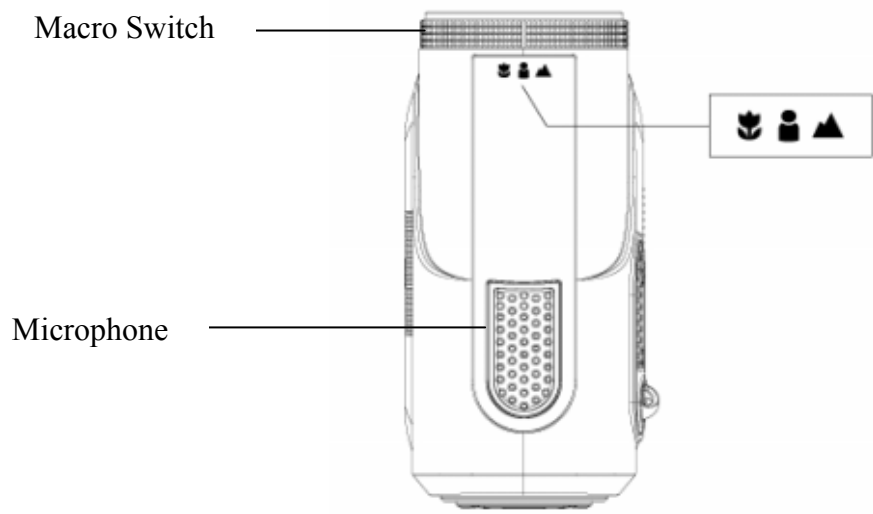
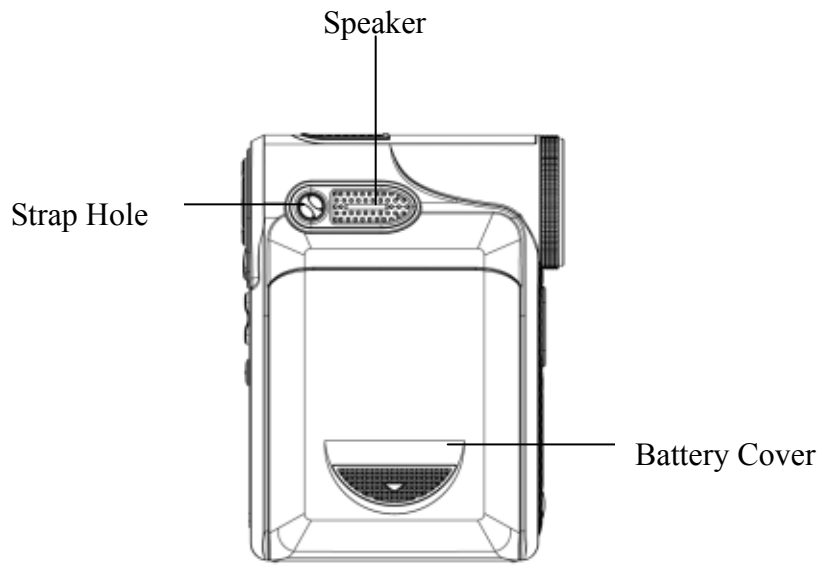

Section 2

Getting Up and Running

◆ Loading the Battery

Before using the camera, end users must load NP60 rechargeable Li-ion Battery.

1. Follow the arrow direction and slide to eject the battery cover.
2. Insert the batteries according to the correct polarity marks (+ or -)
3. Close the battery cover firmly.

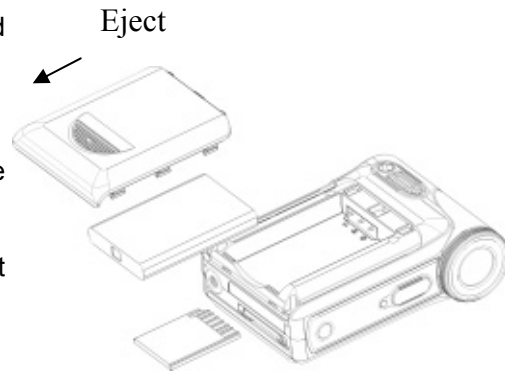

◆ Inserting and Removing an SD Card (Optional)

The camera comes with internal memory which allows you to store pictures, movies, voice recordings and music. You can expand the memory capacity by using an optional SD or MMC memory card up to 2GB. To insert a memory card, refer to the figure as below:

1. Insert the memory card into the right position.
2. To remove an installed SD card, press the card inwards to release it.
3. When the card pops out, gently remove it from its slot.



Note

When a memory card is fitted, movies and pictures are saved on card rather than on the built-in memory.

◆ Protecting Data on an SD Card

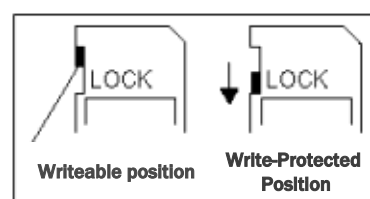

SD card is read-only by locking the SD card. No pictures, movies and voice can be recorded when the SD card is locked. Make sure the lock is on writeable position before recording any media.



◆ Turning the Camera On and Getting Started

To turn on the camera:

- (1) Flip out the LCD panel; the camera will turn on automatically.
- (2) Or press Power Button for one second to turn on it.

- ⇒ To take a movie, press the Movie Shutter Button ().
- ⇒ To take a picture, press the Picture Shutter Button ().
- ⇒ To record the voice, press the Upper Button of Direction Buttons and press the Movie Shutter Button () to start voice recording.
- ⇒ To view stored movies, pictures, listen to stored MP3 and voice recordings, or read eBook, press RECORD/PLAY Button once to switch to Playback Mode. Press a second time to return to Record Mode.







◆ Turning the Camera Off

To turn off the Camera, you can either press the Power Button for one second, or you can place the LCD panel back to its original position.

Section 3

Record Mode

◆ Button Function

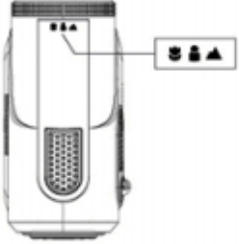

	<p>Right Button : Flash AUTO/OFF</p> <p>Left Button : Self-Timer ON/OFF</p> <p>Up Button : Voice Recording Mode</p> <p>Down Button: LCD Information ON/OFF</p> <p>Enter Button : Menu ON</p>
	<p>Power Button: Press down for one second to turn on or turn off the camera.</p>
	<p>RECORD/PLAY Button functions:</p> <ol style="list-style-type: none"> 1. Switch between Record /Playback Mode. 2. Return to the previous page.
	<p>Tele-Wide Button: Digital Zoom in and out.</p>
	<p>Movie Shutter Button:</p> <ol style="list-style-type: none"> 1. Start to take movie, or record voice. 2. To stop recording, press it again.
	<p>Picture Shutter Button: Start to take picture</p>
	<p>Macro switch: Switch between Macro Mode, Portrait Mode, and Normal Mode.</p>

◆ LCD Monitor Information



The indicator shows below may display on LCD when movies and pictures are recorded :



(1)	Record Mode	
		Movie Record Mode
		Picture Record Mode
		Voice Record Mode
		Motion Stabilization
		Two in One Mode
		Photo Frame
		Multi-Snap Mode
		Backlight Mode
(2)	Resolution	
	Movie :★★High / ★★Standard/ ★ Low	
	Picture: ★★High / ★★Standard/ ★ Low	
(3)	Number of images or recording time of movie that can still be taken at current resolution.	
(4)		SD card inserted
(5)		Macro Position Focusing
(6)	WB	White Balance
(7)	Battery indicator : full power / medium power / low power /	
	power empty	
(8)		Auto Flash
		Flash Off

(9)		Self-timer enabled
(10)		8X digital zoom
(11)		Date/Time : YYYY/MM/DD HH: MM
(12)		Motion Detection

◆ MPEG4 Movie Recording

Press Movie Shutter button () to start recording. When a movie is recording, a time indicator will display on LCD monitor. To stop recording, press Movie Shutter Button () again. Press RECORD/PLAY Button to view the recorded movie. Three resolution settings are available:

Quality
High Quality ★★★
Standard Quality★★
Low Quality ★

◆ Picture Recording



Press the Picture Shutter Button () to take a picture.

Press RECORD/PLAY Button to view the picture.

Three resolution settings are available:



Image Quality
High Quality ★★★
Standard Quality★★
Low Quality ★

◆ Voice Recording

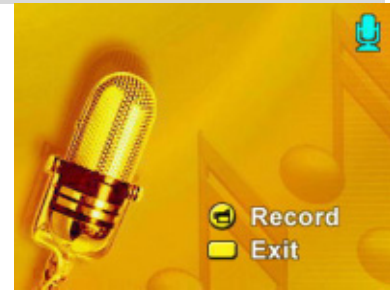



1. Press Upper Button () of Direction Buttons to switch to Voice Record Mode.
2. Press Movie Shutter Button () to record voice.
3. Press Movie Shutter Button () again to stop.
4. Press RECORD/PLAY Button to view the recorded voice.



◆ Taking Close up Pictures

The camera has two close-up picture modes to allow you to take pictures at close range. The Macro Mode () should be used for object located at about 20 cm, while the Portrait Mode () should be used for object located from 70 cm to 140 cm.

To take close-up pictures:

1. Rotate the lens ring to switch to Macro () or Portrait () positions. In Macro Mode, the macro icon () will appear on the LCD monitor.
2. Press Picture Shutter Button () to take the picture.



Note

Remember to turn the macro switch back to Normal () when you are not taking close-up pictures.

◆ Using Digital Zoom



The digital zoom magnifies images, when recording movies or taking pictures.

1. To zoom in/out, press the Tele/Wide Button.
2. The digital zoom can be set from 1x to 8x and the magnification ratio is shown on the LCD monitor.

◆ Options for Record Mode

Movie Mode	Picture Mode	Voice Pen	Effect	Set
<ul style="list-style-type: none"> • Resolution • Exposure • Sharpness • White Balance • Stabilization • Motion Detect • Exit 	<ul style="list-style-type: none"> • Resolution • Exposure • Two in One • Photo Frame • Flash • Self-timer • Sharpness • White Balance • Multi-snap • Backlight • Date printing • Exit 	<ul style="list-style-type: none"> • Enter • Exit 	<ul style="list-style-type: none"> • Normal • B/W • Classic • Negative • Exit 	<ul style="list-style-type: none"> • Sound • Start-up Screen • Time Setting • Format Memory • TV System • Language • Default Setting • Exit

◆ Operations for Record Mode

Operation	Screen
<p>1. Press Enter Button when in Movie/Picture Record Mode.</p>	
<p>2. Use Right/Left Buttons to move between main menu options, which are Movie Mode, Camera Mode, Voice Mode, Effect, and Set. Submenu will pop out while move to each main option.</p> <p>3. Press Enter Button to validate sub option you select.</p> <p>4. Select Exit option to exit submenu.</p>	<p style="text-align: center;">↓ Enter Button</p> 

◆ Default Setting and Validation

The following table indicates the camera's default setting as well as its validation.

1. Always: The setting always keeps valid.
2. One Time: The setting is only valid either once or till camera power off.

	Validation	Default Factory Setting
Resolution	Always	High for Movie Standard for Picture
Exposure	One Time	0EV
Sharpness	One Time	Level 5
White Balance	One Time	Auto
Motion Stabilization	Always	Off
Motion Detect	One Time	Off
Two in One	One Time	Off
Photo Frame	One Time	Off
Flash	Always	Off
Self-Timer	One Time	Off
Multi-Snap	One Time	Off
Backlight Mode	One Time	Off
Date Printing	Always	Off
Effect	One Time	Normal
Sound	Always	On
Format Card	One Time	Off
TV System	Always	Depends on shipping area
Language	Always	Depends on shipping area
Volume	Always	Level 6

◆ Movie Mode submenu Setting

Record main menu includes camera setting and other advanced setting. You can use Right/Left Buttons to move between options and press Enter Button to validate the setting.

◆ Movie Resolution

To change Movie Resolution:

1. In Movie/Picture Record Mode, press Enter Button to switch to record menu screen.
2. Use Right/Left Buttons to select Movie Mode. Submenu of Movie Mode will pop out on the screen.
3. Use Up/Down Buttons to select Resolution then press Enter Button to switch to Resolution submenu.
4. Use Up/Down Buttons to move between three settings.
5. Press Enter Button to validate the setting and exit.

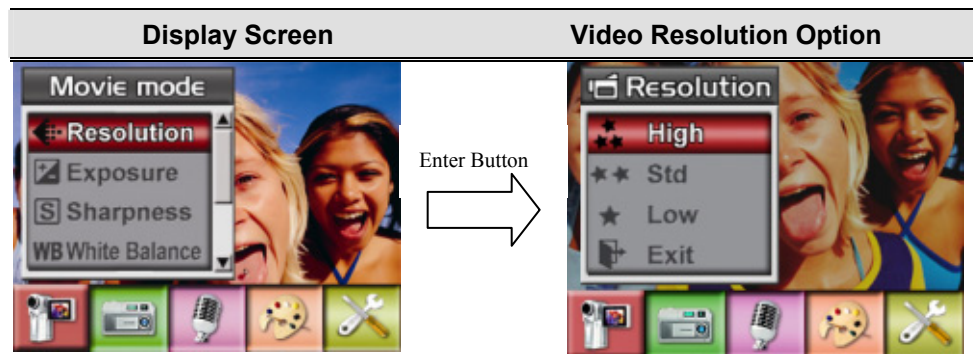

◆ Exposure

The camera adjusts image exposure automatically. In certain circumstances you may wish to adjust the exposure compensation setting.

To change Exposure setting:

1. In Movie/Picture Record Mode, press Enter Button to switch to record menu screen.
2. Use Right/Left Buttons to select Movie Mode. Submenu of Movie Mode will pop out on the screen.
3. Use Up/Down Buttons to move to Exposure Option. Press the Enter Button and then Exposure Submenu will pop out on the screen.
4. Use Up/Down Buttons to choose preferred EV value. The change can be previewed immediately.
5. Press Enter Button to validate the setting and exit.

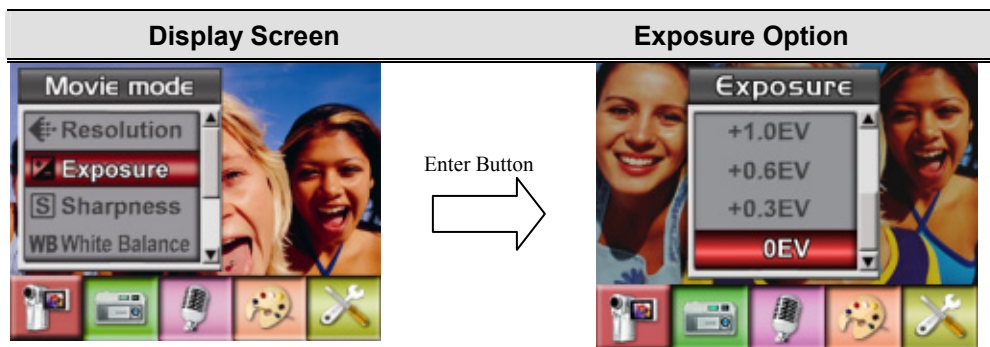

◆ Sharpness

You can soften and sharpen images to achieve different effects.

To change Sharpness setting:

1. In Movie/Picture Record Mode, press Enter Button to switch to record menu screen.
2. Use Right/Left Buttons to select Movie Mode. Submenu of Movie Mode will pop out on the screen.
3. Use Up/Down Buttons to select Sharpness then press Enter Button to switch to Sharpness submenu.
4. Use Up/Down Buttons to move between nine levels. The change can be previewed immediately.
5. Press Enter Button to validate the setting and exit.

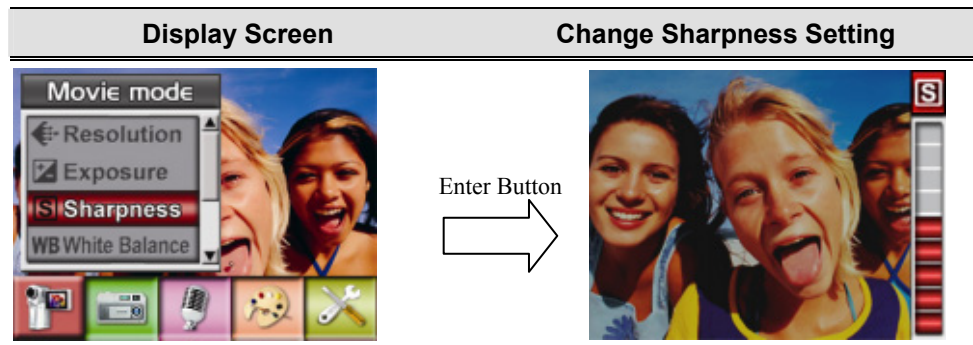

◆ White Balance

The camera adjusts the color balance of images automatically. Three manual white balance settings are available:

1. Auto (Default): The camera automatically adjusts white balance.
2. Daylight: Under outdoors
3. Fluorescent: Under fluorescent light condition.
4. Tungsten: Under tungsten light condition.

To change White Balance Setting:

1. In Movie/Picture Record Mode, press Enter Button to switch to record menu screen.
2. Use Right/Left Buttons to select Movie Mode. Submenu of Movie Mode will pop out on the screen.
3. Use Up/Down Buttons to select White Balance, then press Enter Button to switch to White Balance submenu.
4. Use Up/Down Buttons to move between four settings. The change can be previewed immediately.
5. Press Enter Button to validate the setting and exit.

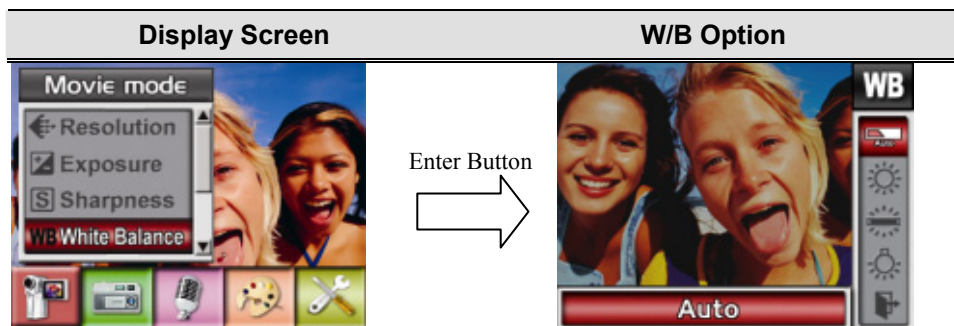

◆ Motion Stabilization

To enable Motion Stabilization:

1. In Movie/Picture Record Mode, press Enter Button to switch to record menu screen.
2. Use Right/Left Buttons to select Movie Mode. Submenu of Movie Mode will pop out on the screen.
3. Use Up/Down Buttons to select Motion Stabilization then press Enter Button to switch to Motion Stabilization submenu.
4. Use Up/Down Buttons to choose ON or OFF.
5. Press Enter Button to validate the setting and exit.

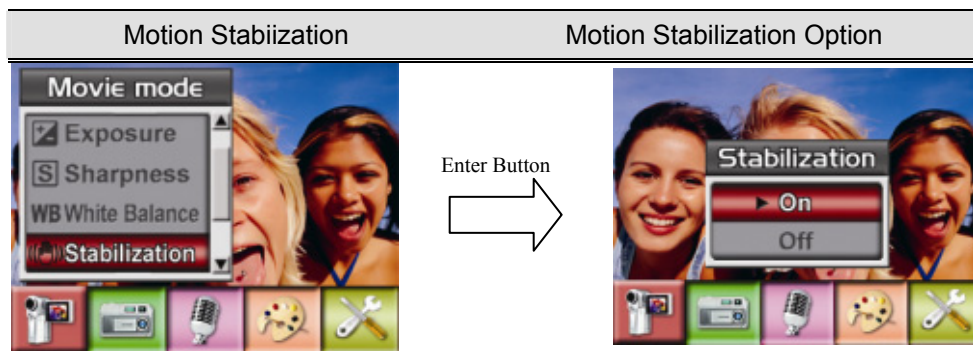

Note

1. The captured screen will be smaller when motion stabilization is enabled.
2. Digital Zoom is disabled when motion stabilization is activated.

◆ Motion Detection

To enable Motion Detection:

1. In Movie/Picture Record Mode, press Enter Button to switch to record menu screen.
2. Use Right/Left Buttons to select Movie Mode. Submenu of Movie Mode will pop out on the screen.
3. Use Up/Down Buttons to select Motion Detect then press Enter Buttons to switch to Motion Detect submenu.
4. Use Up/Down Buttons to choose ON or OFF.
5. Press Enter Button to validate the setting and exit.
6. Camera will start to record video once if there is a movement for 3 consecutive seconds. Stop recording if there is no movement for 3 seconds.

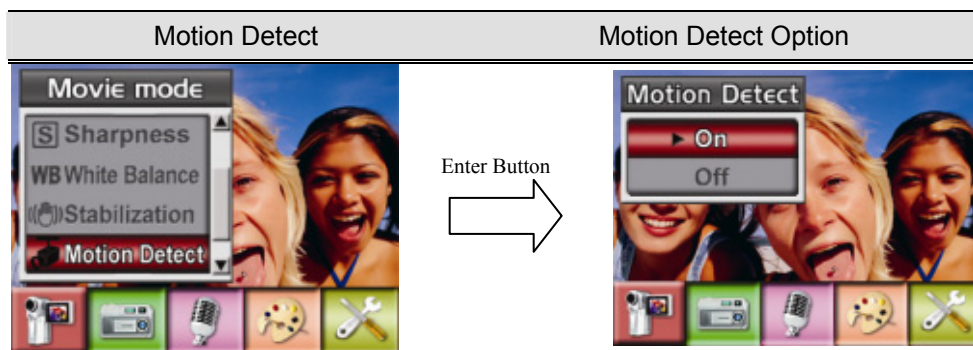

◆ Camera Mode Setting

◆ Picture Resolution

To change Picture Resolution:

1. In Movie/Picture Record Mode, press Enter Button to switch to record menu screen.
2. Use Right/Left Buttons to select Camera Mode. Submenu of Camera Mode will pop out on the screen.
3. Use Up/Down Buttons to select Resolution then press Enter Button to switch to Resolution submenu.
4. Use Up/Down Buttons to move between three settings.
5. Press Enter Button to validate the setting and exit.

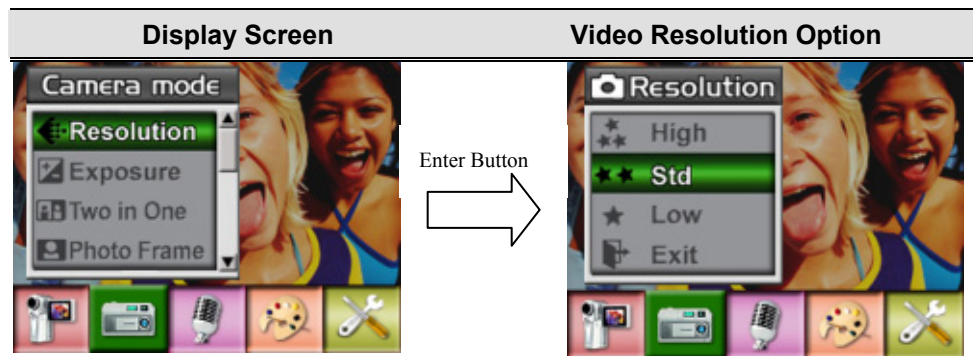

◆ Exposure

The camera adjusts image exposure automatically. In certain circumstances you may wish to adjust the exposure compensation setting.

To change Exposure setting:

1. In Movie/Picture Record Mode, press Enter Button to switch to record menu screen.
2. Use Right/Left Buttons to select Camera Mode. Submenu of Camera Mode will pop out on the screen
3. Use Up/Down Buttons to move to Exposure Option. Press the Enter Button and then Exposure Submenu will pop out on the screen.
4. Use Up/Down Buttons to choose preferred EV value. The change can be previewed immediately.
5. Press Enter Button to validate the setting and exit.

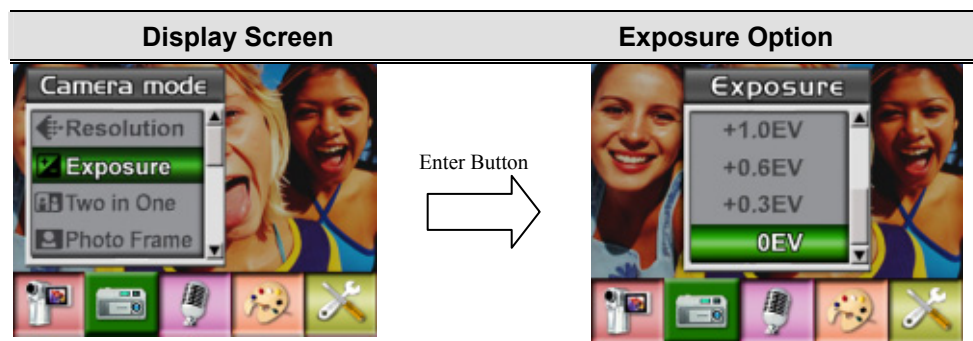

◆ **Two in One (Picture Record Mode Only)**

With camera set to Two in One mode, you can combine two snapshots into one picture. To enable Two in One:

1. In Movie/Picture Record Mode, press Enter Button to switch to record menu screen.
2. Use Right/Left Buttons to select Camera Mode. Submenu of Camera Mode will pop out on the screen.
3. Use Up/Down Buttons to select Two in One then press Enter Button to switch to Two in One submenu.
4. Use Up/Down Buttons to choose ON or OFF.
5. Press Enter Button to validate the setting and exit.

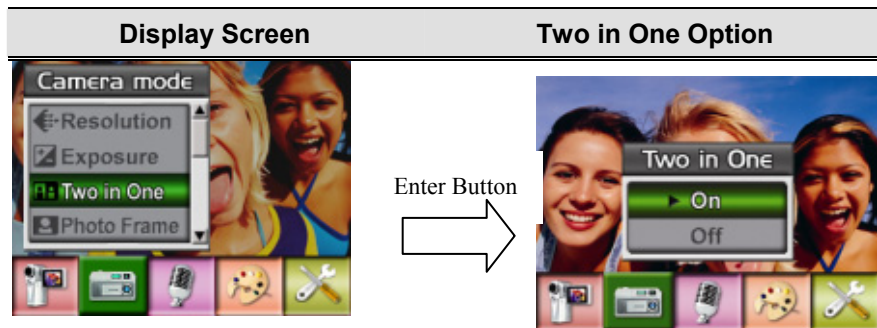

1. Press Picture Shutter Button to take first picture.



2. Press Picture Shutter Button to take second picture.



3. Press the RECORD/PLAY Button to view the Two in One picture.



◆ **Photo Frame (Picture Record Mode Only)**

Your camera features popular electronic photo frame. You can take your picture with preferred electronic photo frame. To enable Photo Frame:

1. When in Camera Mode, use Up/Down Buttons to select Photo Frame option, then press Enter Button to switch to Photo Frame submenu.
2. Use Up/Down Buttons to locate preferred photo frame. Then select Set option and press Enter Button to validate the setting and exit.

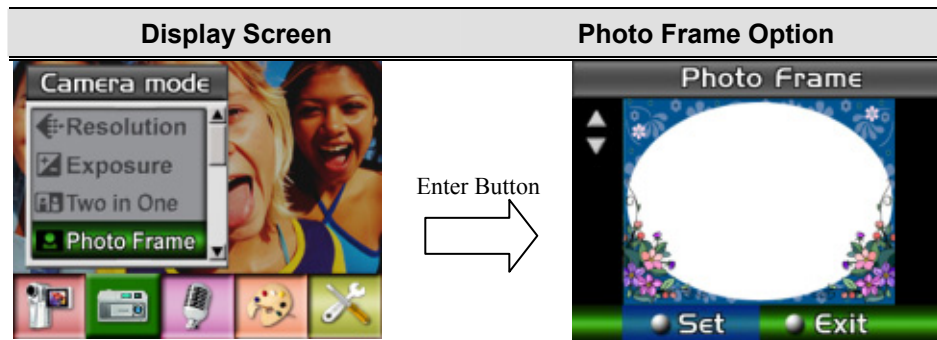

◆ Flash (Picture Record Mode Only)

This camera has two flash settings. To change flash setting by either hot key (Right Button) or Option Setting.

🔦 **Auto-flash**(A🔦) : the flash fires automatically according to light conditions. Use this mode for general photography.

🔦 **Flash Off**(🔦) : the flash will not fire under any circumstances. Use this mode when taking images in a place where flash photography is prohibited, or when the subject is distant (beyond the range of the flash).

To change Flash setting:

1. When in Camera Mode, use Up/Down Buttons to select Flash Option, then press Enter Button to switch to Flash submenu.
2. Use Up/Down Buttons to move between 2 settings.
3. Press Enter Button to validate the setting and exit.



Note

- The flash will be disabled automatically when battery power is low (🔋)

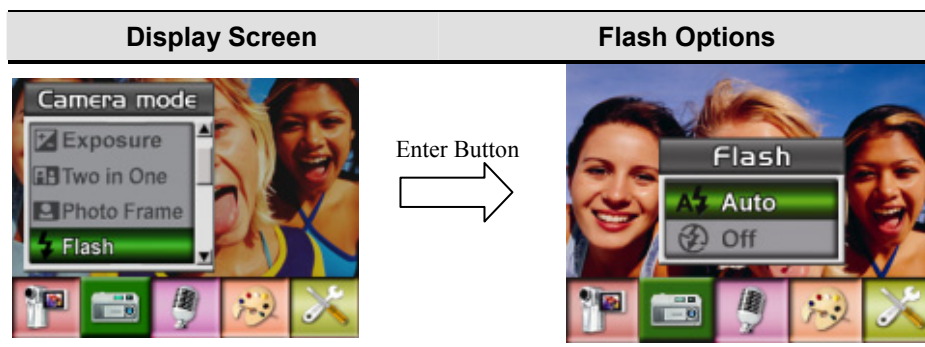

◆ Self-timer (Picture Record Mode Only)

The self-timer allows you to take pictures with a ten-second time delay. To activate Self-timer by either hot key (Left Button) or Option Setting. The self-timer LED on the front of the camera beneath the flash light will also blink. The speed of blinking will increase just before the picture is taken.

To enable Self-timer:

1. When in Camera Mode, use Up/Down Buttons to select Self-timer, then press Enter Button to switch to Self-timer submenu.
2. Use Up/Down Buttons to choose On or Off.
3. Press Enter Button to validate the setting and exit.

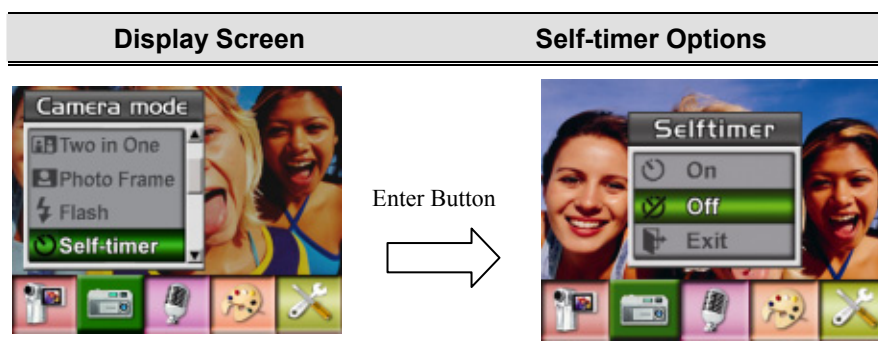

◆ Sharpness

You can soften and sharpen images to achieve different effects.

To change Sharpness setting:

1. When in Camera Mode, use Up/Down Buttons to select Sharpness Option, then press Enter Button to switch to Sharpness submenu.
2. Use Up/Down Buttons to select Sharpness then press Enter Button to switch to Sharpness submenu.
3. Use Up/Down Buttons to move between nine levels. The change can be previewed immediately.
4. Press Enter Button to validate the setting and exit.

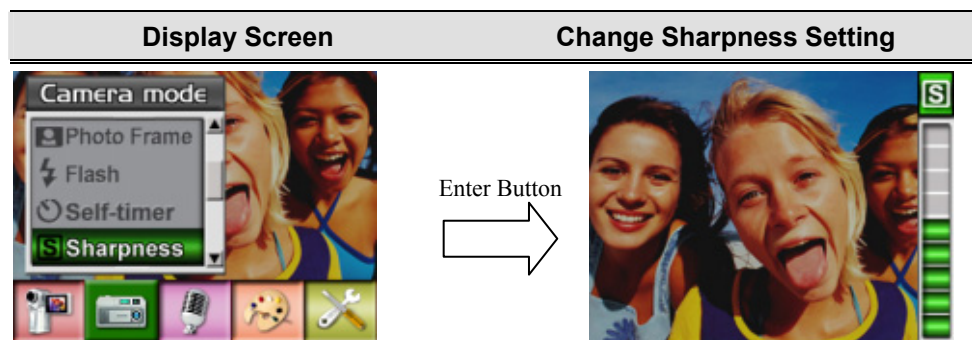

◆ White Balance

The camera adjusts the color balance of images automatically. Three manual white balance settings are available:

1. Auto (Default): The camera automatically adjusts white balance.
2. Daylight: Under outdoors
3. Fluorescent: Under fluorescent light condition.
4. Tungsten: Under tungsten light condition.

To change White Balance Setting:

1. In Movie/Picture Record Mode, press Enter Button to switch to record menu screen.
2. Use Right/Left Buttons to select Camera Mode. Submenu of Camera Mode will pop out on the screen.
3. Use Up/Down Buttons to select White Balance, then press Enter Button to switch to White Balance submenu.
4. Use Up/Down Buttons to move between four settings. The change can be previewed immediately.
5. Press Enter Button to validate the setting and exit.

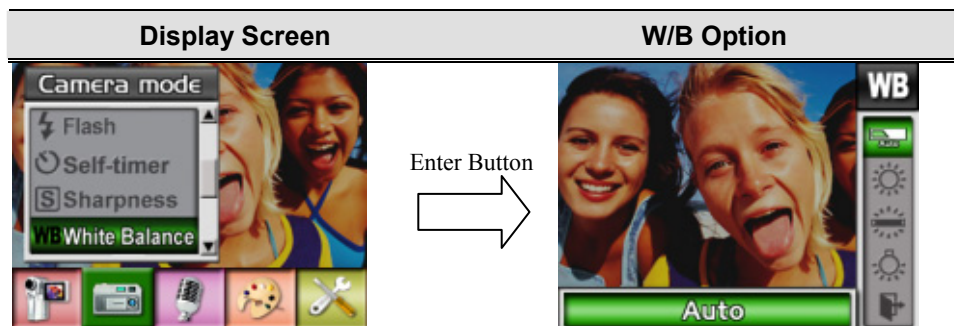

◆ Multi-Snap (Picture Record Mode Only)

With the camera set to Multi-Snap Mode, you can take five continuous pictures.

To enable Multi-Snap:

1. When in Camera Mode, use Up/Down Buttons to select Multi-Snap, then press Enter Button to switch to Multi-Snap submenu.
2. Use Up/Down Buttons to choose On or Off.
3. Press Enter Button to validate the setting and exit.

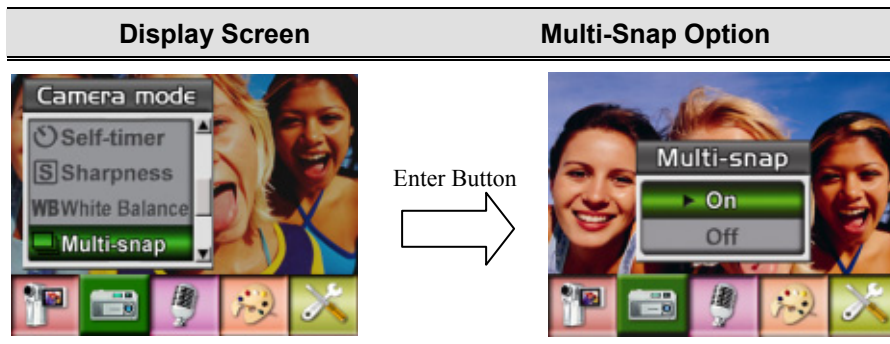

◆ Backlight (Picture Record Mode Only)

With the camera set to backlight Mode, you can take shots when bright light is behind the subject.

To enable Backlight:

1. When in Camera Mode, use Up/Down Buttons to select Backlight, then press Enter Buttons to switch to Backlight submenu.
2. Use Up/Down Buttons to choose On or Off.
3. Press Enter Button to validate the setting and exit.

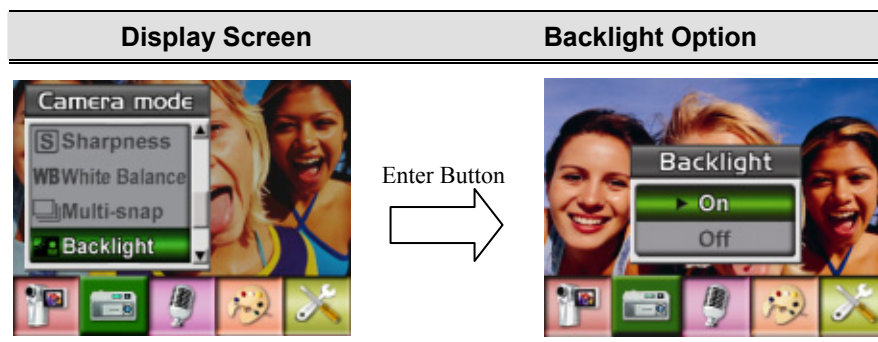

◆ Date Printing

To enable Date Printing:

1. When in Camera Mode, use Up/Down Buttons to select Date Printing, then press Enter Buttons to switch to Date Printing submenu.
2. Use Up/Down Buttons to choose On or Off.
3. Press Enter Button to validate the setting and exit.

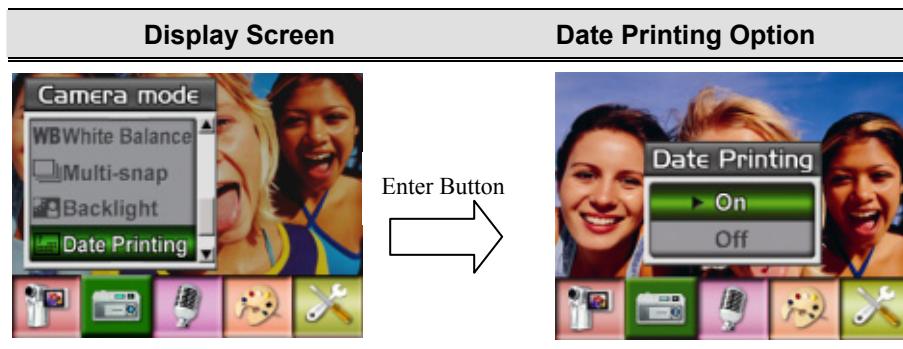

Note

Date would be shown on the printed picture once date printing is enabled.

◆ Voice Mode

To enable voice recording:

1. In Movie/Picture Record Mode, press Enter Button to switch to record menu screen.
2. Use Right/Left Buttons to move to Voice Option. Then Voice Submenu will pop out on the screen.
3. Use Up/Down Button to move between Enter and Exit Option.
4. Choose Enter option to enable voice recording and press Enter Button to validate the setting and exit.

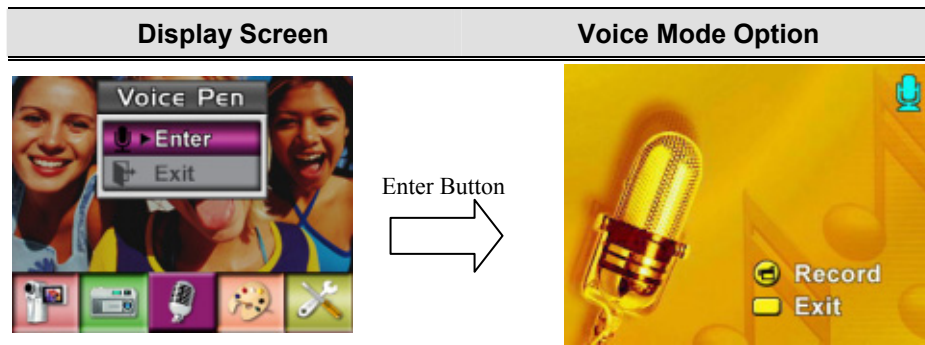

◆ Effect Setting

There are four modes which are Normal, Black/White, Classic and Negative.

To change Effect setting:

1. In Movie/Picture Record Mode, press Enter Button to switch to record menu screen.
2. Use Right/Left Buttons to move to Effect Option. Then Effect Submenu will pop out on the screen.
3. Use Up/Down Buttons to move between four settings. The change can be previewed immediately.
4. Press Enter Button to validate the setting and exit.

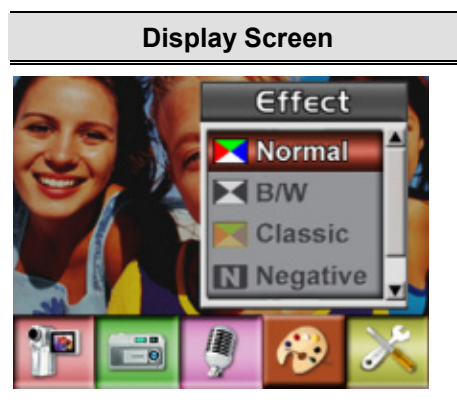

◆ Setting Menu

The Setting submenu contains options for configuring your camera set up.



To change advanced setting:

1. In Movie/Picture Record Mode, press Enter Button to switch to record menu screen.
2. Use Right/Left Buttons to move to Setting option, then Setting Submenu will pop out on the screen.
3. Use Up/Down Buttons to move between settings.

Display Screen	Setting Option
	<ul style="list-style-type: none"> • Sound (operation sound) • Start-Up Screen • Time Setting • Format Card • TV System • Language • Default Setting

• Sound Setting

Enable or disable Keypad tone and operation sound by using Up/Down Buttons, then press the Enter Button to validate the setting.

Submenu	Display Screen	Sound Setting
Sound		

- **Start-up Screen**

Customize the Start-Up Screen with your favorite pictures. Press Right/Left Buttons to select the picture you want and press Enter Button to validate the setting and exit.

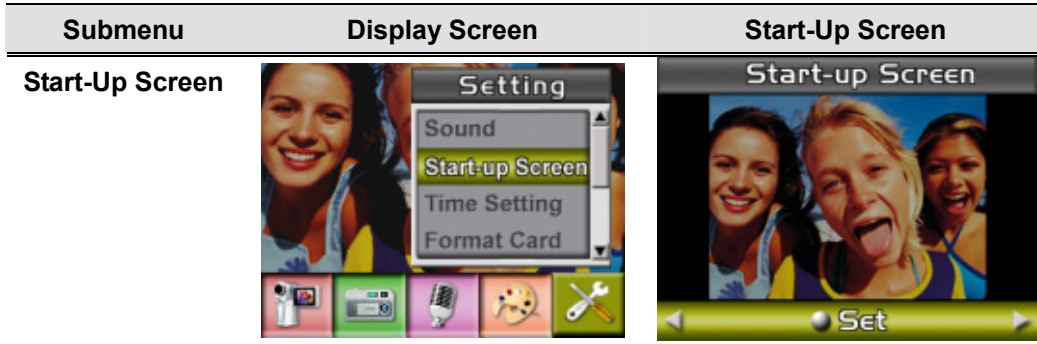

If you do not want to customize the start up screen, press Left/Right Buttons and select No Start-Up Screen.

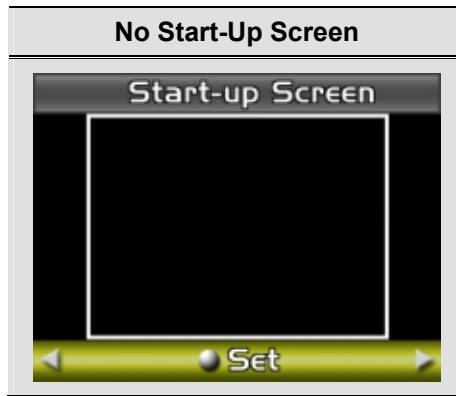

- **Time Setting**

- Move between Date, Time, Set and Exit by using Left/Right Buttons.
- Adjust date and time by using Up/Down Buttons, then select Set to validate each change.
- Select Exit to leave Time Setting without any change.

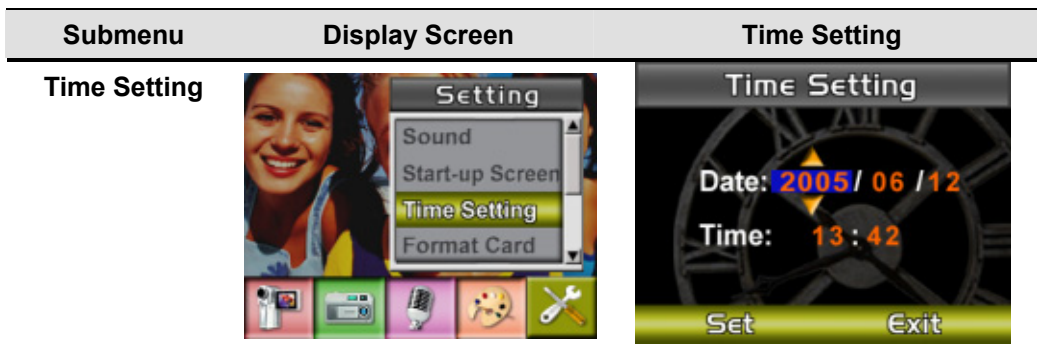

- **Format Card**

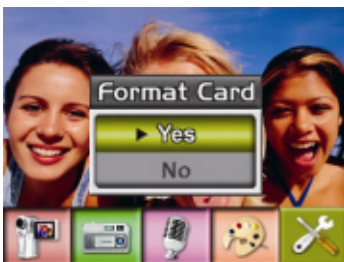
Submenu	Display Screen	Format Card Options
Format Card		

Yes : Format the SD Card / built-in memory

No (Default) : Do not format SD Card / built in memory



Note

- All the data will be erased if the SD card is formatted. Make sure all the data are duplicated to PC before formatting SD card.



TV System

Ensure that the appropriate TV standard of your area is selected – either NTSC or PAL.

Wrong TV system setting may cause image flicker.

NTSC standard: USA, Canada, Japan, South Korea and Taiwan etc.

PAL standard: UK, Europe, China, Australia, Singapore and Hong Kong etc.



Submenu	Display Screen	TV System Option
TV System		

- **Selecting Interface Language**

Submenu	Display Screen
Language	

- **Default Setting**

To restore the default factory setting, select this option.

Submenu	Display Screen	Default Setting Options
Default Setting		

Section 4

Playback Mode

Press RECORD/PLAY Button to switch from Record Mode to Playback Mode.

The Playback Mode is for viewing and managing movies and pictures as well as listening to voice and music, or read eBook on the built-in memory or on an optional memory card.

Operation	Display Screen
<p>Press RECORD/PLAY Button to switch from Record Mode to Playback Mode Main Menu.</p> <ul style="list-style-type: none">• There are five options in the Playback Mode, movie, picture, voice, music, and eBook.• Direction Buttons can be used to select the specific option. <p>Press Enter Button to view movies/pictures, listen to voice/music, or read eBook.</p>	 <p>The screenshot shows a grid of five menu items: 'Movie' (red background with a camera icon), 'Picture' (blue background with a photo icon), 'Music' (purple background with a CD icon), 'Voice' (yellow background with a microphone icon), and 'eBook' (green background with an open book icon).</p>







Note

When any recorded movie, picture, voice, music, or eBook is stored in the camera, a folder will be shown on the respective playback mode.

◆ Button Functions

The Direction Buttons have the following functions in Movie and Picture Playback Modes.

	<p>Right Button : Go to the next movie/ picture.</p> <p>Left Button : Go to the previous movie/ picture.</p> <p>Up Button : Invalid</p> <p>Down Button : Information ON/OFF</p> <p>Enter Button : Enter to movie, picture, voice, music or e-Book option menu.</p>
	<p>RECORD/PLAY Button functions:</p> <ol style="list-style-type: none"> 1. Switch between Record and Playback modes. 2. Return to the previous page.
	<p>Tele-Wide Button: Digital Zoom in and out.</p>
	<p>Movie Shutter Button :</p> <p>Start playing the recorded movie or voice</p>



◆ LCD Monitor Information

Indicators on the LCD screen while in Playback Mode :



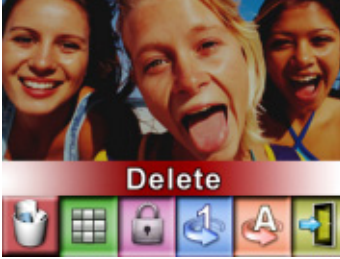

(1)	Mode Indicator	
		Movie Playback Mode
		Picture Playback Mode
		Voice Playback Mode
		Music Playback Mode
		eBook Playback Mode
(2)	Resolution Indicator	
		High Resolution
		Standard Resolution
		Low Resolution
(3)	Indicate the selected movie/picture is locked.	
	Indicate the single movie/voice/MP3 is being repeated.	
	Indicate all of the movies/voices/MP3 are being repeated.	
	Indicate the slide show is playing.	
(4)	Current Number/ Total number of movie, picture, voice, or MP3.	
(5)	Magnification Indicator.	

◆ Movie Playback

Operation	Display Screen
<ol style="list-style-type: none"> 1. Use Direction Buttons to select the Movie option. 2. Press Enter Button to go to Movie Playback Mode. 	 <p>The display screen shows a main menu with five color-coded buttons: 'Movie' (red), 'Picture' (blue), 'Music' (purple), 'Voice' (yellow), and 'eBook' (green). Each button has a corresponding icon: a camera for Movie, a TV for Picture, a CD for Music, a microphone for Voice, and an open book for eBook.</p>
<ol style="list-style-type: none"> 3. Use Right/Left Buttons to go to the next or last movie. 4. Press Movie Shutter Button to play and press it again to pause. 5. While playing movie, press Right/Left Buttons to fast forward/backward, then release the button to stop. 6. Use Up/Down Buttons to adjust volume. 	 <p>The display screen shows a movie frame with three people. In the top left corner, it displays '5 / 10'. On the right side, there are playback controls including a play/pause button, a stop button, and a volume control overlay with 'Vol+' and 'Vol-' indicators and left/right arrows.</p>
<ol style="list-style-type: none"> 7. Press Enter Button to go to the movie option menu. 8. Use Direction Buttons to select six options, Delete, Thumbnail, Lock, Repeat One, Repeat All, or Exit. 	 <p>The display screen shows the same movie frame. A 'Delete' menu overlay is visible at the bottom, with the word 'Delete' in white text on a red background. Below the text are six icons: a trash can, a grid, a lock, a '1' button, an 'A' button, and a right arrow.</p>

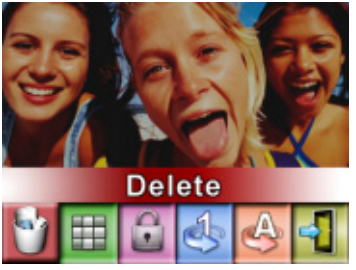
◆ Delete Movies

Operation	Display Screen
<p>1. Use Direction Buttons to select the Delete option ().</p>	
<p>2. Press Enter Button to go to the Delete menu.</p> <p>3. Use Right/Left Buttons to select the movie.</p> <p>4. Use Up Button to delete all movies and Down Button to delete single movie.</p> <p>5. Before a movie is deleted, a confirmation screen will appear; choosing “Yes” will execute the operation and “No” to cancel the operation.</p> <p>6. Press Enter Button to exit.</p>	



Note

If a memory card is fitted, you can delete only those movies stored on the card.



Note



Movies on a written-protected memory card cannot be deleted.



Note



The delete function will only erase unlocked movies. Locked movies must be unlocked before being deleted.

◆ Thumbnail Function

Operation	Display Screen
<p>1. Use Direction Buttons to select the Thumbnail option ().</p>	
<p>2. Press Enter Button to view nine thumbnail movies. 3. To play a movie, use Direction Buttons to select the movie and press Enter Button to view.</p>	



◆ Lock Movies

Single or all movies can be locked. This function can prevent the movies from being deleted accidentally.



Operation	Display Screen
<p>1. Use Direction Buttons to select the Lock option ().</p> <p>2. Press Enter Button to go to the Lock menu.</p>	
<p>3. Use Right/Left Buttons to select the movie.</p> <p>4. Use Up Button to lock/unlock all movies and Down Button to lock/unlock single movie.</p> <p>5. Before a movie is locked/unlocked, a confirmation screen will appear; choosing “Yes” will execute the operation, “No” will cancel the operation.</p> <p>6. Press Enter Button to exit.</p>	

◆ Repeat Movies

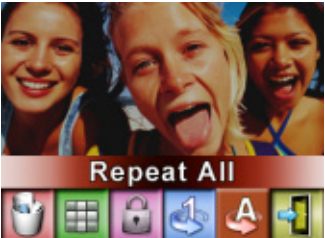

This function automatically repeats playing single movie or all movies in order.

Operation	Display Screen
<p>1. Use Direction Buttons to select the Repeat One option () or Repeat All option ().</p> <p>2. Press Enter Button to start repeating.</p>	 

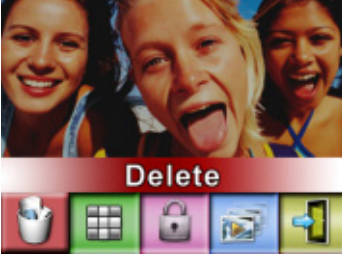
◆ Picture Playback

Operation	Display Screen
<ol style="list-style-type: none"> 1. Use Direction Buttons to select the Picture option. 2. Press Enter Button to go to Picture Playback Mode. 	 <p>The display screen shows a main menu with five options: 'Movie' (red background with a camera icon), 'Picture' (blue background with a camera icon), 'Music' (purple background with a CD icon), 'Voice' (yellow background with a microphone icon), and 'eBook' (green background with an open book icon).</p>
<ol style="list-style-type: none"> 3. Use Right/Left Buttons to go to the next or last picture. 4. While the picture is selected, use Tele/Wide Buttons to magnify. 5. Use Direction Buttons to navigate the magnified picture. 	 <p>The display screen shows a magnified photo of three people. The photo is centered, and a magnifying glass icon is visible in the bottom right corner. The top left corner shows '4/17' and the top right corner shows a lock icon and other navigation icons.</p>
<ol style="list-style-type: none"> 6. Press Enter Button to go to the picture option menu. 7. Use Direction Buttons to select five options, Delete, Thumbnail, Lock, Slideshow, or Exit. 	 <p>The display screen shows a magnified photo of three people. Below the photo is a menu with five options: 'Delete' (red background with a trash can icon), 'Thumbnail' (green background with a grid icon), 'Lock' (purple background with a lock icon), 'Slideshow' (blue background with a film strip icon), and 'Exit' (yellow background with a right arrow icon).</p>

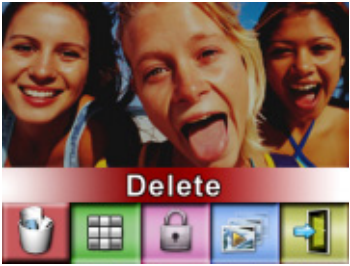
◆ Delete Picture

Operation	Display Screen
<p>1. Use Direction Buttons to select the Delete option ().</p>	
<p>2. Press Enter Button to go to the Delete menu.</p> <p>3. Use Right/Left Buttons to select the picture.</p> <p>4. Use Up Button to delete all pictures and Down Button to delete single picture.</p> <p>5. Before a picture is deleted, a confirmation screen will appear; choosing “Yes” will execute the operation, “No” will cancel the operation.</p> <p>6. Press Enter Button to exit.</p>	



Note

If a memory card is fitted, you can delete only those pictures stored on the card.



Note



Pictures on a written-protected memory card cannot be deleted.



Note

The delete function will only erase unlocked pictures. Locked pictures must be unlocked before being deleted.

◆ **Thumbnail Function**

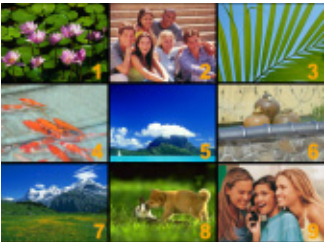
Operation	Display Screen
<p>1. Use Direction Buttons to select the Thumbnail option ().</p>	
<p>2. While selecting Thumbnail option, press Enter Button to view nine thumbnail pictures.</p> <p>3. To view a picture, use Direction Buttons to select the picture.</p> <p>4. Press Enter Button to view the selected picture.</p>	

◆ **Lock Pictures**

Single or all pictures can be locked. This function can prevent the pictures from being deleted accidentally.

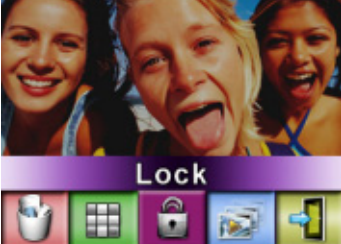
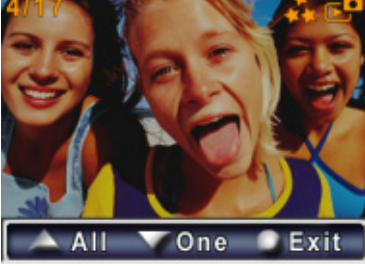
Operation	Display Screen
<p>1. Use Direction Buttons to select the Lock option ().</p>	
<p>2. Press Enter Button to go to the Lock menu.</p> <p>3. Use Right/Left Buttons to select the picture.</p> <p>4. Use Up Button to lock/unlock all pictures and Down Button to lock/unlock single picture.</p> <p>5. Before a picture is locked/unlocked, a confirmation screen will appear; choosing “Yes” will execute the operation, “No” will cancel the operation.</p> <p>6. Press Enter Button to exit.</p>	

◆ Make Slide Show

This function automatically repeats all pictures in order.

Operation	Display Screen
<ol style="list-style-type: none">1. Use Direction Buttons to select the Slide option (📺).2. Press Enter Button to start the slide show; Press it again to stop.	 The image shows a digital display screen. The top portion features a photograph of three young women smiling and laughing. Below the photo is a blue horizontal bar with the text "Slide Show" in white. At the bottom of the screen is a row of five colorful icons: a trash can, a grid of four squares, a padlock, a photo of a landscape, and a smartphone with a right-pointing arrow.

◆ Voice Playback

◆ Direction Buttons Function

In Voice Playback Mode, the Direction Buttons have the following functions:

	<p>Right/ Left Buttons : Select the last or next voice.</p> <p>Up/Down Buttons : Adjust the voice playback volume.</p> <p>Enter Button : Switch to voice option menu.</p>
---	--

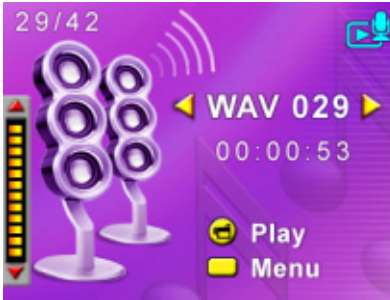
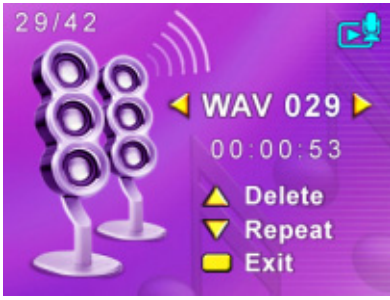
Operation	Display Screen
<ol style="list-style-type: none"> 1. Use Direction Buttons to select the Voice option. 2. Press Enter Button to go to Voice Playback Mode. 	
<ol style="list-style-type: none"> 3. Use Right/Left Buttons to go to the next or last voice recording. 4. Press Movie Shutter Button to start playing back the selected voice. Press it again to stop. 5. Use Up/Down Buttons to adjust the volume. 6. Press Enter Button to go to the voice playback option menu. 	
<ol style="list-style-type: none"> 7. Use Up Button to select Delete option and Down Button to select Repeat option. 	

8. Press Up Button once to repeat single voice; Press twice to repeat all voice recording.

9. Press it again to disable the repeat function.

10. The repeat icons will be different while selecting Repeat One option and Repeat All option.

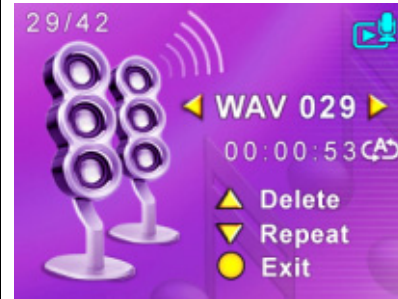
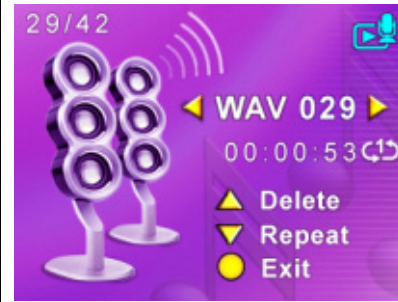

11. To delete a voice, use Right/Left Buttons to select the voice.

12. Use Up Button to delete all voice recordings and Down Button to delete single voice recording.

13. Before a voice is deleted, a confirmation screen will appear; choosing "Yes" will execute the operation, "No" will cancel the operation.

14. Press Enter Button to exit.



Section 5

Listening to MP3 Music



◆ MP3 Music

MP3 is a compressed audio file format. The MP3 music can be downloaded from some MP3 web sites. This DV includes the feature of MP3 play with lyrics display. To enable this function, make sure both .mp3 and .lrc files with the same file name are copied to the memory.

◆ Transfer MP3 Music to the camera

1. Install the camera driver on your computer.
2. Connect your camera to the computer USB port.
3. The Red LED will light when the camera is connected to the computer and in Mass Storage Mode.
4. Transfer MP3 music to My Computer\Removable Disk\MP3.
5. Once all the music is transferred, disconnect the USB cable from the PC.

◆ Listen to MP3 Music

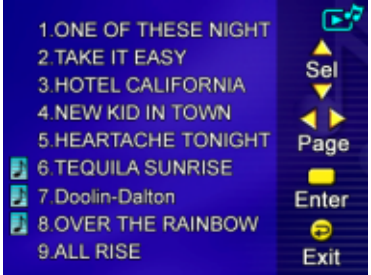
Operation	Display Screen
1. In Playback Mode, use Direction Buttons to select the Music option	
2. Use Up/Down Buttons to locate MP3 you want to play, or press Right/Left Buttons to jump to the next/previous page. There is an icon  in the front for those MP3 with Lyrics display.	

3. Press Movie Shutter or Enter Button to play MP3
4. Press Movie Shutter Button again to stop playing.
5. Press Up/Down Buttons to adjust volume.

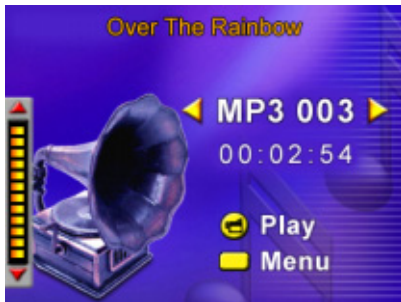

6. Press Enter Button to go to repeat menu.
7. Press Down Button once to repeat current MP3(↻).
8. Press Down Button twice to repeat all MP3(↻).
9. Press Enter Button to exit.

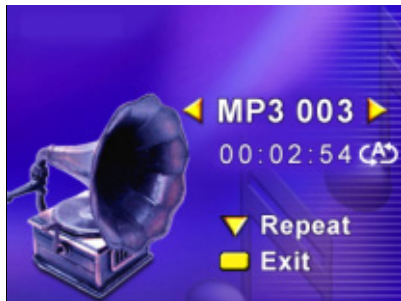
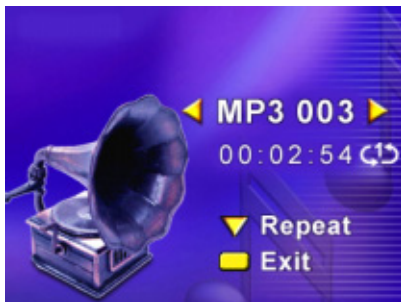

◆ Listen to MP3 Music with earphone

MP3 stored in the camera can be played either by built-in speaker, or Earphone, or TV.

When the earphone cable is plugged in the camera, the option menu of Earphone/TV pops out on the LCD Screen. Choose earphone or TV and press Enter Button to validate the setting.



Section 6

Reading eBook



◆ eBook





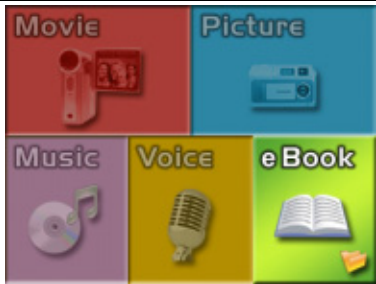

An eBook is an electronic edition of a physical book. eBooks in your camera have many features that traditional paper books do not: you have the freedom to control the look and feel of your eBook through colors, your own bookmarks, carrying your eBooks anywhere with your camera.

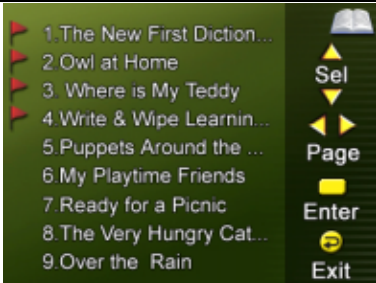
◆ Transfer eBooks to the camera

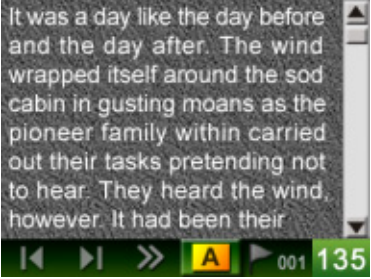
1. Install the camera driver on your computer.
2. Connect your camera to the computer USB port.
3. The Red LED will light when the camera is connected to the computer and in Mass Storage Mode.
4. Transfer eBooks, .txt file format only, to My Computer\Removable Disk\Book.
5. Once all the files is transferred, disconnect the USB cable from the PC.

◆ Read eBooks

Operation	Display Screen
1. In Playback Mode, use Direction Buttons to select the eBook option	
2. Use Up/Down Buttons to select eBook you want to read, or press Right/Left Buttons to jump to the next/previous page. There is an icon  in the front for those eBooks with bookmark added.	

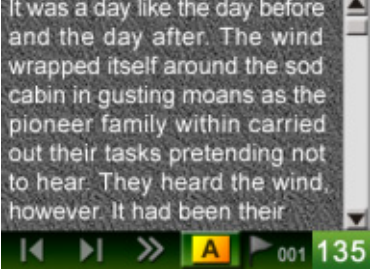
<p>3. Press Enter Button to read the eBook.</p> <p>4. Press Up/Down Buttons to scroll up/down the text</p>	 <p>The screenshot shows a text passage: "It was a day like the day before and the day after. The wind wrapped itself around the sod cabin in gusting moans as the pioneer family within carried out their tasks pretending not to hear. They heard the wind, however. It had been their". Below the text is a navigation bar with buttons for back, forward, and auto-scroll, along with a page number indicator showing "001 135".</p>
<p>5. Select  to jump to the first page</p> <p>6. Select  to jump to the last page</p> <p>7. Select  to change the color of text and background.</p> <p>8. Select  to auto scroll down the text.</p> <p>9. Select  to add a bookmark.</p>	 <p>The screenshot is identical to the one above, showing the same text passage and navigation bar with "001 135" on the page indicator.</p>

Viewing MPEG4 Movie on PC

◆ MPEG4 Movie

MPEG4, the multimedia format and compression standards, is a cutting-edge compression technology developed by MPEG (Motion Picture Expert Group). It not only enhances the image quality but also improves the efficiency of recording capacity.

MPEG4 is adopted in this camera to take DVD-quality MPEG4 movies. The MPEG4 movie format of AVI is used in this camera.

◆ View MPEG4 Movie on PC

When playing an MPEG4 movie for the first time, MPEG4 Video Codec Xvid should be installed in PC. To do this:

- (1) Insert the CD-ROM into the computer's CD-ROM drive. Click "Install Device Driver" (Install MPEG4 Video Codec Xvid) and follow the on-screen instructions to complete the installation.
- (2) Start video player such as Widows Media Player to view MPEG4 AVI Movies.

◆ Share MPEG4 Movie

You can share the recorded MPEG4 movies to your friends via internet or CD. Make sure MPEG4 Video Codec Xvid is installed in your friends' PC. MPEG4 Video Codec Xvid is available in the provided CD or can be downloaded from Internet.

Section 8

Viewing Pictures and Movies on a TV

You can view stored movies and pictures on a television. To connect to a television:

1. Connect one end of the AV cable to your camera's AV Out port.
2. Connect the other end of the cable to a television.
3. The option menu of Earphone/TV pops out on the LCD Screen.



4. Choose TV option and press Enter Button to validate the setting.
5. The steps for viewing stored pictures and movie on a TV are exactly the same as for viewing them on the LCD monitor.



Note

The LCD monitor does not work when the camera is connected to a television.

Section 9

Video File Converter

Bundled software CD contains Acrsoft Media Converter that features video file converter to convert multiple video formats into MPEG4 Xvid compatible format with your camera. In this way, you can convert any format of video files and playback your favorite movies on your camera.

To convert a video file:

- (1) Install Arcsoft Media Converter (Refer to section 12)
- (2) Click Start→ Select Programs→ Acrsoft Media Converter→ Media Converter
- (3) Media Converter main Screen will appear on your desktop.
- (4) Follow Step 1 and click “Select Media”

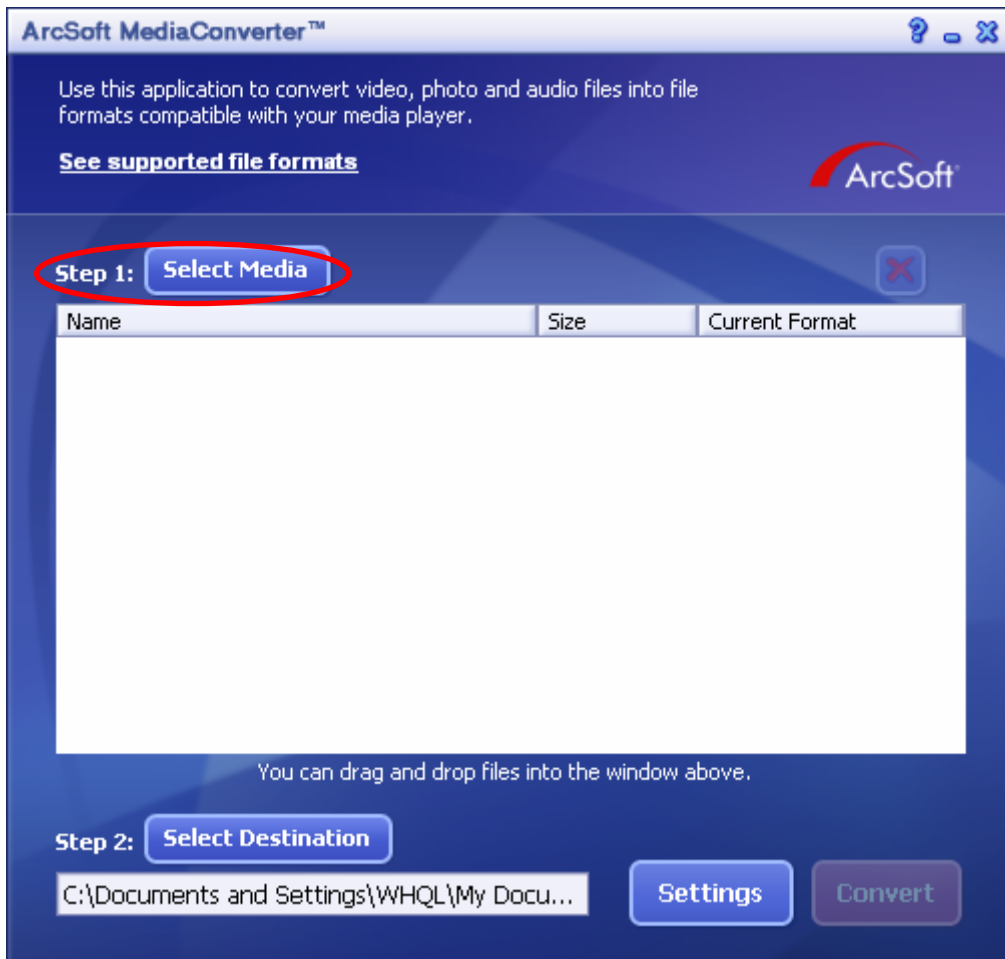

(5) Select the video file you want to convert.

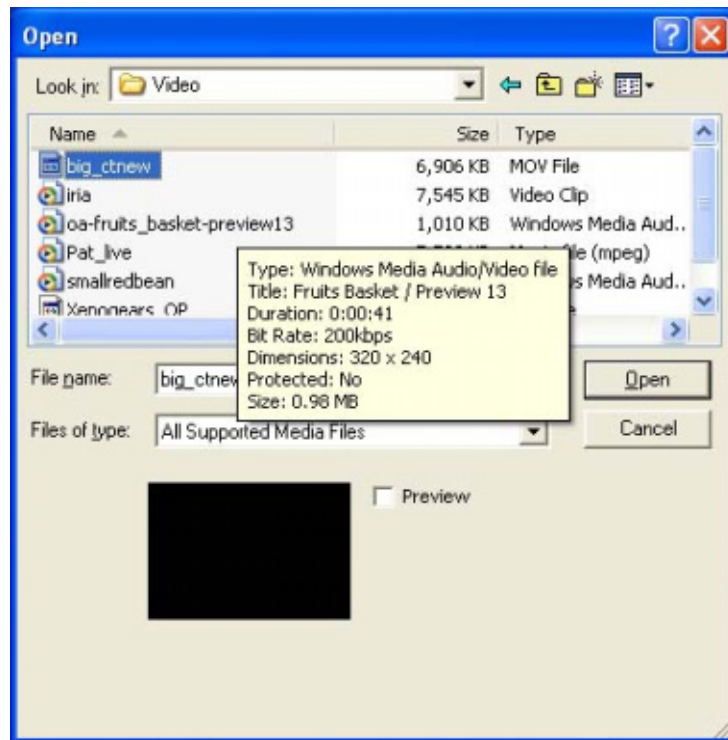

(6) Follow Step 2 and click "Select Destination" to choose the location you want to store the converted video file.

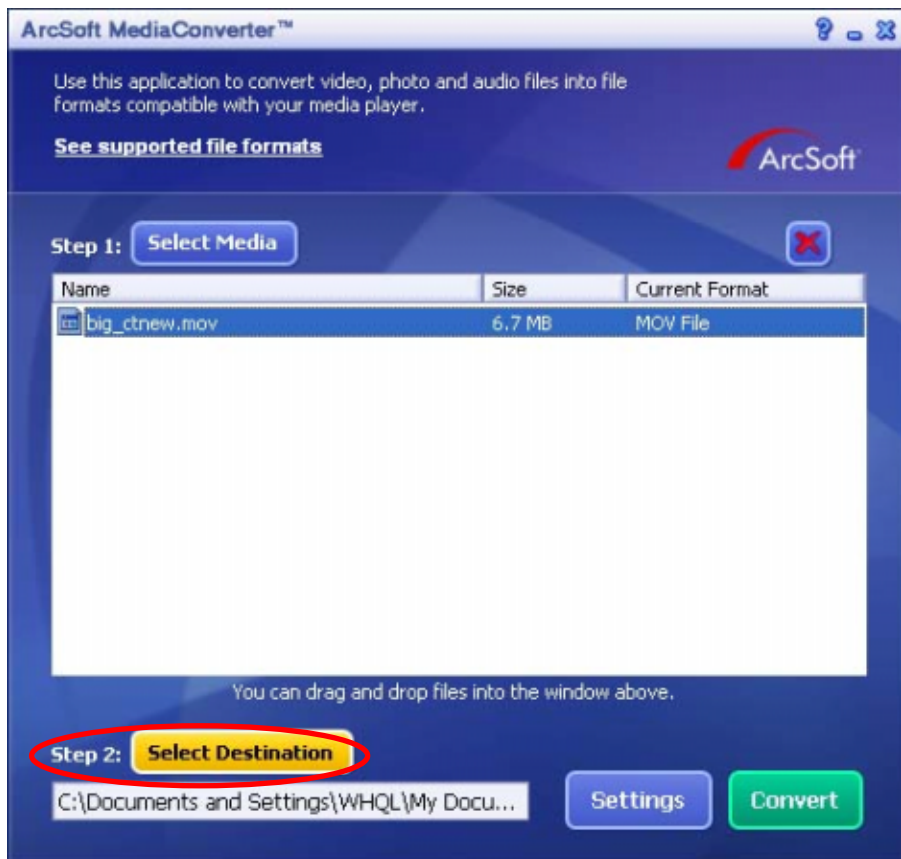

(7) Click "Convert" to start video converting.

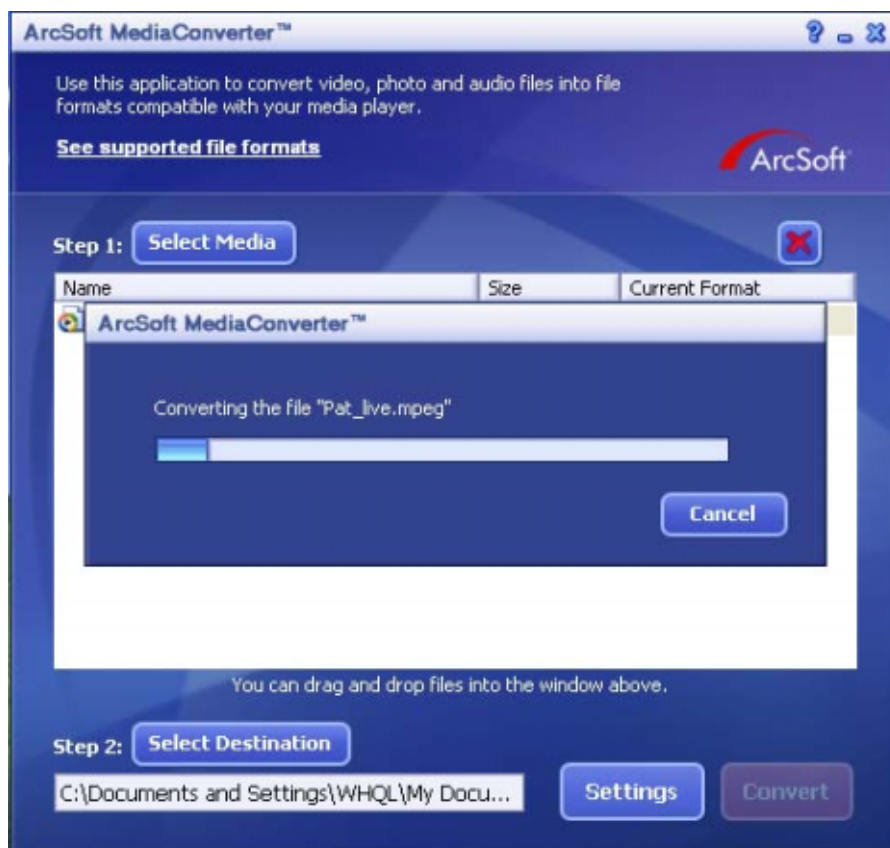
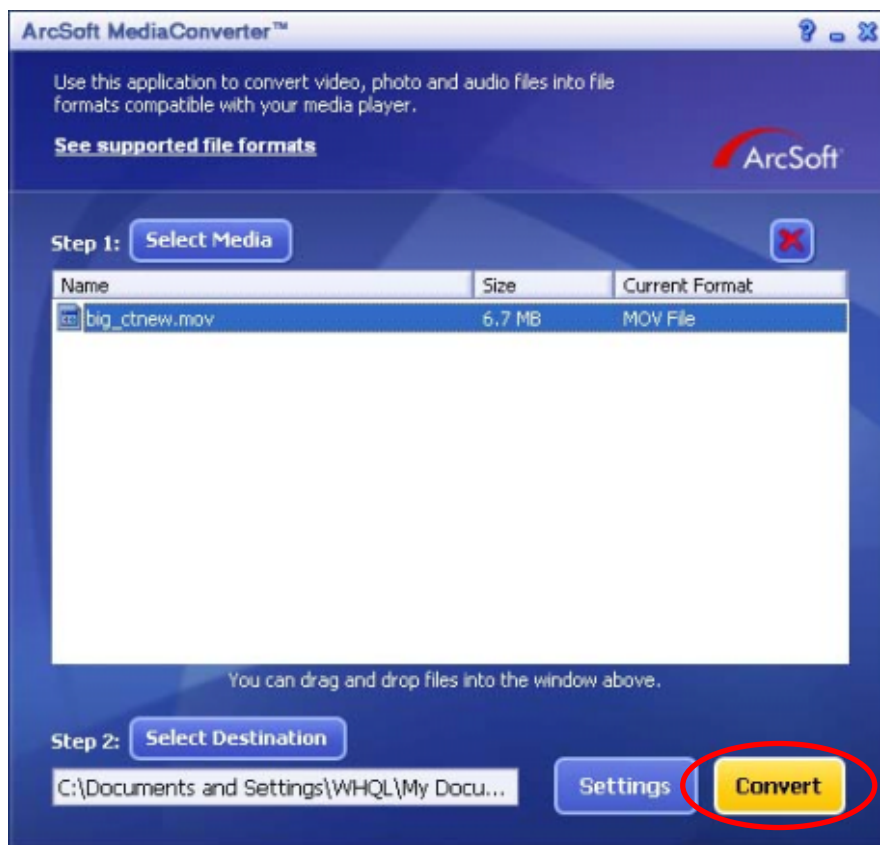

(8) Task Report window will pop out after the task is completed.

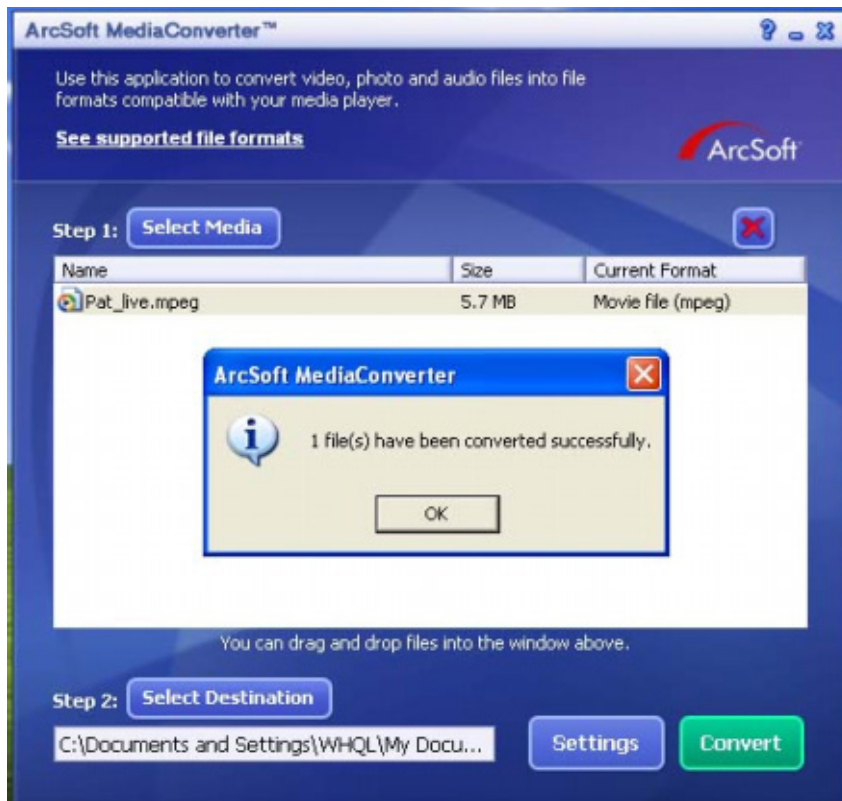

- (9) Before transferring the converted file to your camera, rename the converted file to "Clip0001.avi". (Please note: if Clip0001.avi exists in the camera, then the converted file has to be renamed to clip0002.avi)
- (10) Connect your camera to PC and transfer the converted video to "My Computer\Removable Disk\DCIM\200Movie" in your camera. (Refer to Section 10 Transferring Data to a Computer)
- (11) After transferring the converted video to the camera, press RECORD/Play Button to enjoy your favorite movie.

Section 10

Burning the Recorded Clip into DVD

Bundled software CD contains ArcSoft Showbiz DVD also features burning the movie clip into DVD. You can preserve your precious movies on DVD to share with family and friends. To create a DVD:

- (1) Install Arcsoft Showbiz DVD (Refer to section 11)
- (2) Click Start→ Select Programs→ Acrsoft Showbiz DVD→ Showbiz DVD
- (3) Showbiz DVD main Screen will appear on your desktop.
- (4) Drag Video File to “ Drag Video Here”

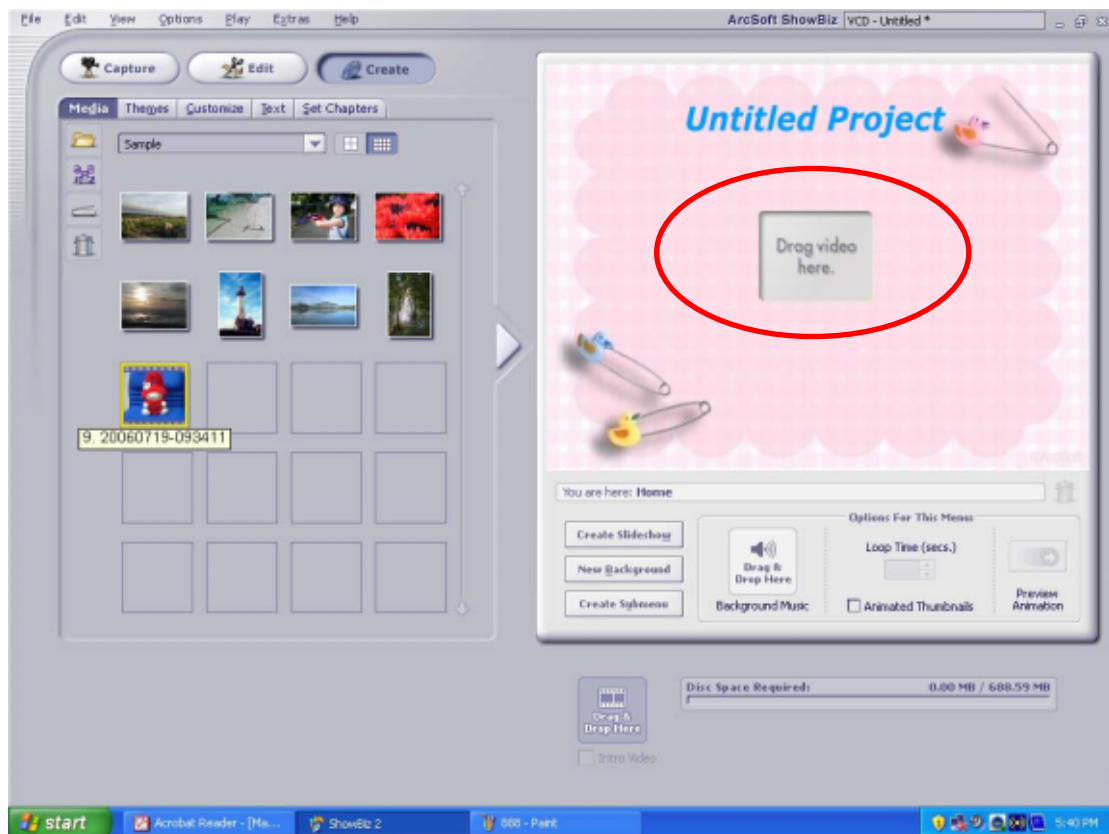

(5) Click "Create"

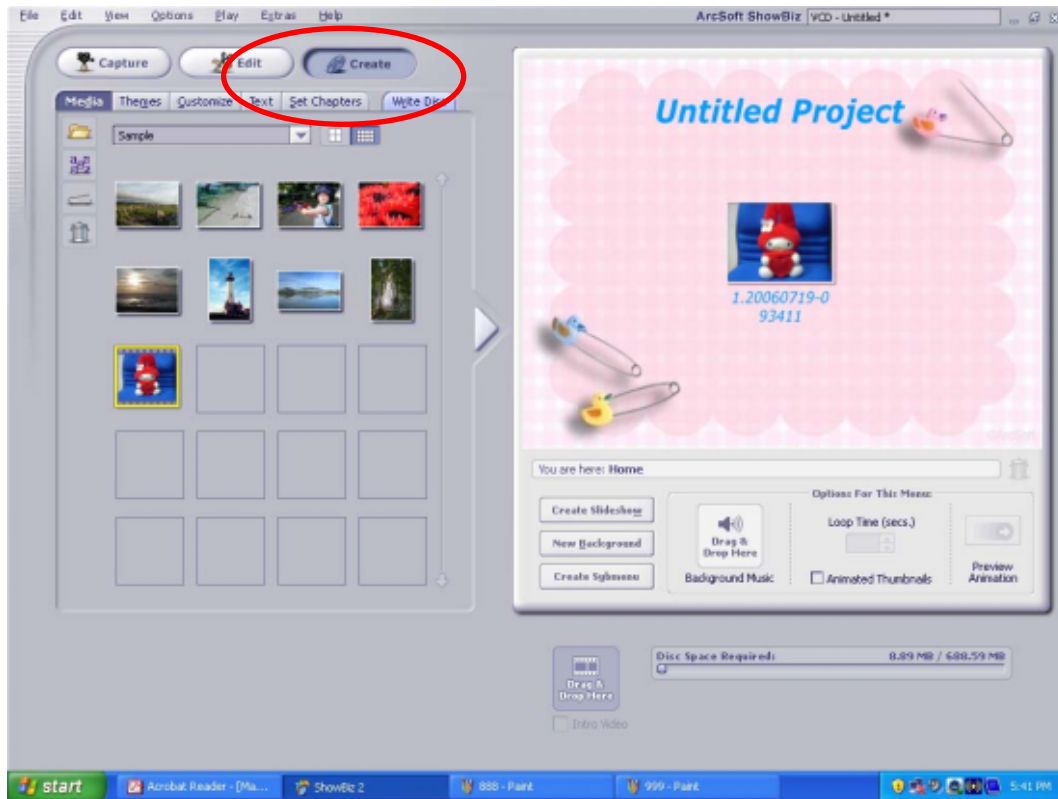

(6) Click "Start" to start DVD burning

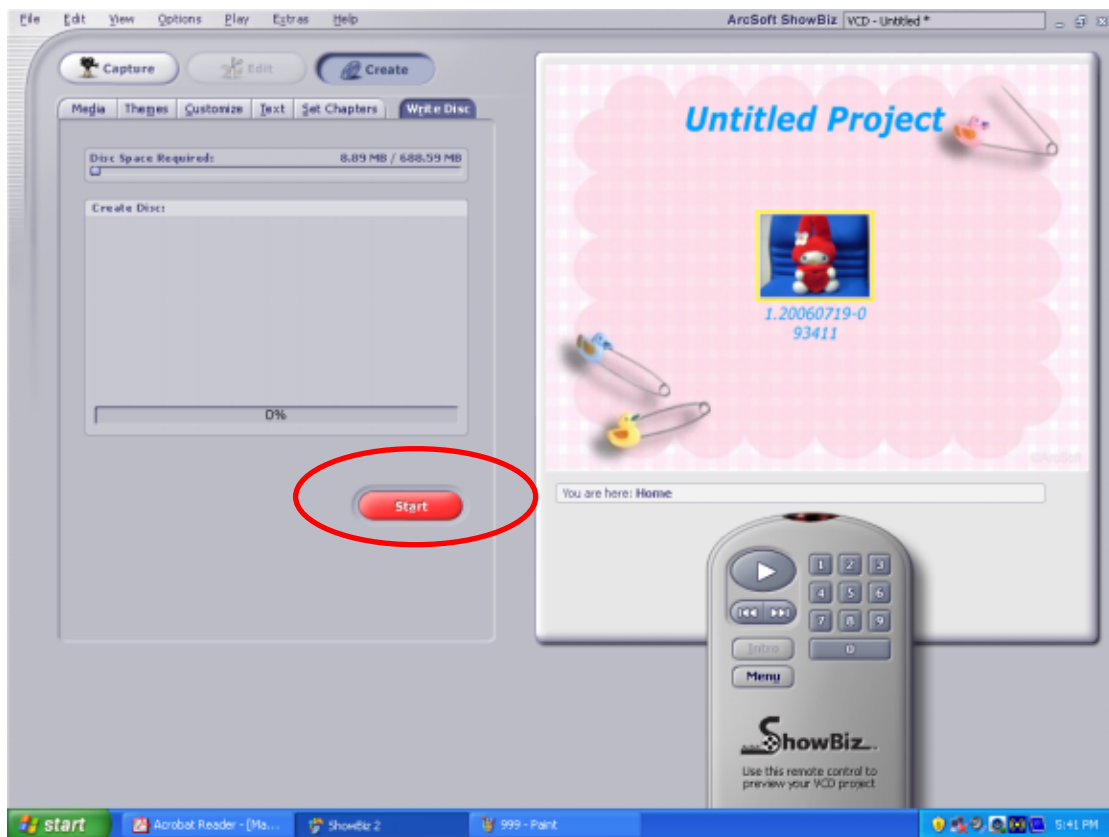

Transferring Data to a Computer

◆ Installing the Digital Camera Driver

Before connecting this camera to a computer for the first time, you should install a driver on the computer. The driver is on the CD-ROM disc provided in the package. To install the driver:

1. Insert the CD-ROM into the computer's CD-ROM drive. The autorun screen will appear.
2. Click "Install Device Driver". Follow the on-screen instructions to complete the installation. Depending on your operating system, you may have to restart your computer after installing the driver.

◆ Connecting Your Camera to a Computer

You can transfer pictures, movies or voice recordings stored on your camera to a computer and send them in emails to friends or post them on websites. To do this you should:

1. Install the camera driver on your computer.
2. Connect the computer and camera with the supplied mini USB 2.0 cable.
3. Default mode is Mass Storage Mode when the camera connects to PC
4. Transfer pictures or movies or MP3 or voice recordings

◆ Mass Storage Device Mode

The RED LED will light up when the camera is connected to the computer. Movies, pictures and voice recordings can be found on your computer at "My Computer\Removable Disk\DCIM". Under this mode, you can read, delete, move, or copy any movie/picture/voice recording you want. Use the bundled Ulead application software to edit the movies or pictures.

◆ PC Camera Mode

When in Mass Storage Device Mode, press RECORD/PLAY Button to switch to PC Camera Mode and the GREEN LED will light up. Under this mode, you can implement live video conference meetings or use video email over the Internet.

◆ Installing Bundled Software

The CD-ROM supplied with this camera contains 5 pieces of software.

- ⇒ **Acrsoft PhotoImpression** is a user-friendly application that helps you read, edit and organize images.
- ⇒ **Acrsoft Show Biz** allows you to edit movies and is equally easy to use.
- ⇒ **Arcsoft Media Converter can** convert multiple video formats into MPEG4 Xvid compatible format with your camera
- ⇒ **Acrobat Reader** is a popular program that you need to have installed to read the User's Manual. Many computer users will find they already have this software installed on their computer.
- ⇒ **MPEG4 Video Codec Xvid**, this decode software has to be installed for correctly viewing the movies you record.

The detail information can be found in online help of all the bundled software.

To install the bundled software:

1. Insert the CD-ROM into your computer's CD-ROM drive. The autorun screen appears.
2. Select the piece(s) of software you want to install from the list, then click **Install Application Software**. Follow the on-screen instructions to complete the installation.

Specifications and System Requirements

◆ Specification

Image Sensor	5 Mega Pixel Sensor
Operation Modes	Movie Record · Picture Record · Voice Record · e-Book · MP3 Player · PC Camera · Mass Storage Device
Lens	F3.0 (f = 7.0 mm)
Focus Range	140cm~infinite (Normal Mode) 60cm ~ 140cm (Portrait Mode) Center: 20 cm (Macro Mode)
Digital Zoom	8X
Shutter	Electronic
LCD monitor	2.4" LTPS TFT LCD
Storage Media	Built-in 64MB Memory (partial memory is used for Firmware code); SD/MMC Card Slot support (up to 2GB)
Image Resolution	Still image 3840x2880 (11M Pixels) 2592x1944 (5M Pixels) 1600x1200 (2M Pixels)
Movie Resolution	VGA 640x480 pixels 30 fps QVGA 320x240 pixels 30 fps
White Balance	Auto/Manual (Daylight, Fluorescent, Tungsten)
Exposure	Auto/Manual
Self-Timer	10 second delay
Flash	Auto/Off
File Format	Picture : JPEG Movie : AVI (Xvid) Voice : WAV Music : MP3
Image play	Single Image/Thumbnails/Slideshow
PC Interface	Mini USB 2.0 Port
TV out	NTSC/PAL Selectable
Battery	Lithium-ion Rechargeable Battery
Dimension	95mm×71mm×34mm
Weight	142g (without battery)

◆ System Requirement

Windows 98SE/2000/ME/XP

Pentium MMX 、 Celeron or AMD Athlon®
CPU

64MB RAM

CD ROM

500MB free HDD space

Available USB port

16-bit Color Display